

IMPORTANT SERVICE ACTIVITIES

Check items		Check and Service Intervals	Page
Engine oil	D1146 DE12	Change : At end of first 1,000km, High-speed, long distance : every 15,000km In city, short distance : every 10,000km	102 Page
	DE08TiS	Change : At end of first 1,000km, long distance : every 30,000km Short distance : every 20,000km	
Engine oil filter		Change with engine oil	103 Page
Fuel filter	D1146	Primary filter : clean at every 5,000km, change at every 15,000km there after. Secondary filter : change at every 5,000km.	105 Page
	DE08TiS DE12	Change at every 20,000km.	
Valve clearance		Adjust at end of first 1,000km and every 20,000km there after.	110 Page
Air cleaner		Change at every 4,000km, change at every 12,000km there after.	115 Page
Transmission oil		Change at end of first 5,000km and every 20,000km there after.	117 Page
Rear axle oil		Change at end of first 5,000km and every 20,000km there after.	118 Page
Power steering oil		Change at end of first 1,000km and every 24,000km there after.	119 Page
Power steering filter		Change at end of first 1,000km and every 24,000km there after.	121 Page

* Any failure resulting from a lack of normal maintenance as the maintenance service chart in this manual is not covered by warranty.

FOREWORD

This manual has been prepared to acquaint you with the operation and maintenance of your DAEWOO BUSES and to provide important safety information. We urge you to read it carefully and follow the recommendations to help assure the most enjoyable, safe and troublefree operation of your vehicle.

When it comes to service, remember that your DAEWOO dealer knows your vehicle best and is interested in your complete satisfaction.

We would like to take this opportunity to thank you for choosing a DAEWOO product and assure you of our continuing interest in your motoring pleasure and satisfaction.

This manual should be considered as a permanent part of your vehicle, and must remain with the vehicle at the time of resale.



DAEWOO MOTOR CO., LTD.
BUSAN, KOREA

All information, illustrations and specifications contained in this manual are based on the latest product information available at time of publication.

The right is reserved to make changes at any time without notice.

TABLE OF CONTENTS

1. IMPORTANT INFORMATION	2
2. OPERATION AND CARE OF NEW VEHICLE	4
3. GETTING ON AND OFF, DRIVER'S SEAT AND BELT	6
4. INSTRUMENT, SWITCHES AND CONTROLS	13
5. DRIVING	73
6. INSPECTION AND MAINTENANCE	101
7. LUBRICATION	154
8. SCHEDULED MAINTENANCE SERVICE	159
9. TROUBLESHOOTING	163
10. MAIN DATA AND SPECIFICATION	172
11. BODY DIMENSION	188

IMPORTANT INFORMATION

LOCATION OF ENGINE NUMBER AND CHASSIS NUMBER

It is advisable to keep note of the engine number and chassis number as they are required when contacting your dealer for repair services and parts order.

V.I.N plate

V.I.N(Vehicle identification Number) plate is attached to the inner panel above the front door.

Type A : Applicable for vehicles in all countries except GCC members.

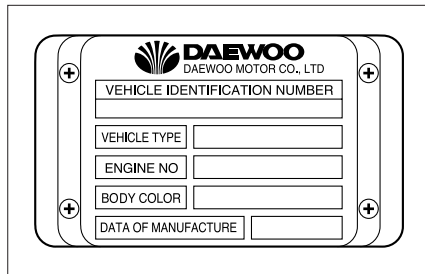

Type B : Applicable for vehicles in GCC members.

(I)



(II)

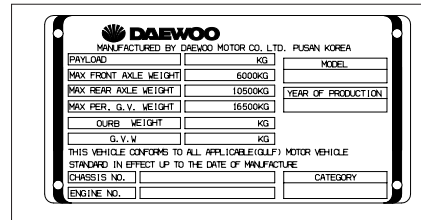

Chassis number

The chassis number is stamped on the upper face of the chassis frame within the engine compartment.

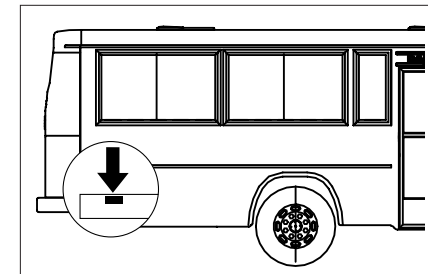

Engine number

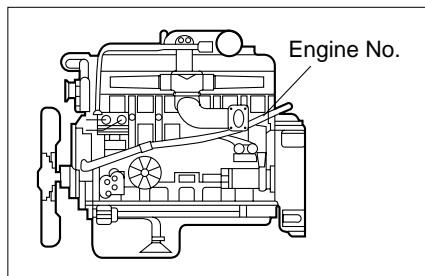

Key

There are three types of key for the bus ;

- Engine starting
- Mechanical locking for entrance door(OPTION)
- Door
 - Entrance door operating
 - Driver door(OPTION)
 - Fuel inspection door(OPTION)
 - Tool box door(OPTION)
 - Luggage doors(OPTION)
 - Battery inspection door(OPTION)

The keys are not interchangeable.

The code number of each key is stamped on the key.

Record the key number and keep it in a safe place.

In the event that the original key is lost, duplicating can be done using the key code information.

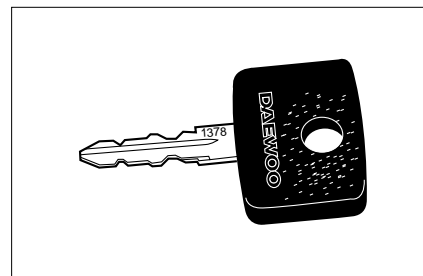

OPERATION AND CARE OF NEW VEHICLE

It is important to observe the following precautions as operation and care of the vehicle, particularly during the break-in period have a strong influence over the performance and service life of the vehicle.

1. Start and let the engine idle until it becomes thoroughly warmed up and coolant temperature increases beyond 50°C (or 125°F) before starting off.
2. Avoid racing the engine, abrupt starts and hard stops.
3. Avoid over loading the vehicle during and after the break-in period.

Over loading

Over loading not only shortens the service life of your vehicle but also create serious potential safety hazards.

The weight of payload must be limited within the GVW rating and distributed over the front and rear axles so as not to exceed the axle capacities.

Refer to "MAIN DATA AND SPECIFICATION" for GVW and Axle capacity.

Maintenance

In order to maintain safe and dependable vehicle operation, inspection and adjustment should be performed as outlined in "INSPECTION AND MAINTENANCE".

Your DAEWOO dealer is willing to perform regular maintenance operation on your vehicle.

Engine oil change

Change engine oil filter cartridge to new one at the same time with engine oil.

Engine Model	Change Interval
D1146 DE12	At end of first 1,000km High-speed, long distance : every 15,000km In city, short distance : every 10,000km
DE08TiS	At end of first 1,000km Long distance : every 30,000km Short distance : every 20,000km

Maximum engine speed

During the initial milage(Break-in period : 2,000km), confine engine speed to 70% of the maximum and scan the tachometer as you drive to prevent engine over-running.

After the break-in period, increase the engine speed gradually to complete running-in of the vital parts.

GETTING ON AND OFF, DRIVER'S SEAT AND BELT

DOOR OPENING AND CLOSING

(Applicable for vehicles in all entrance door with mechanical key)

When opening the front door to get in, first unlock the mechanical key on the entrance door and operate the entrance key on the right side of the front middle panel.

When closing the front door to get off, open the front door by operating the door control switch and get off.

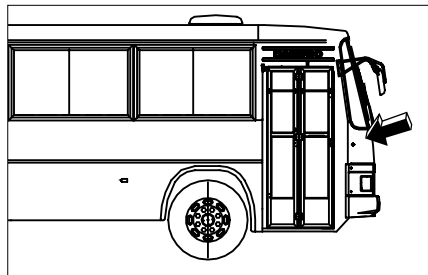

In the outside of bus, close the door with the key and look the mechanical key on the entrance door not to be opened in case of air leaking.

NOTICE

Before operating entrance key, unlock mechanical key on door frame.

CAUTION

When opening front entrance door for a long time, setting emergency valve at manual position and put control switch in close position. When returning to automatic condition, putting control switch and door in same condition and set emergency valve at automatic position.

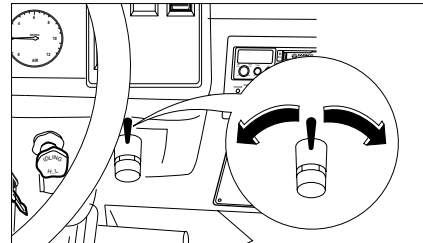

(Applicable for vehicles in all entrance door except mechanical key)

When opening the front door to get in, operate the entrance key on the right side of the front middle panel. When closing the front door to get off, open the front door by operating the door control switch and get off. In the outside of bus, close the door with the key.

DRIVER'S SEAT AND BELT

Adjustment of non suspension type driver's seat (S-104H Type)

1. Back angle adjustment
To adjust the seat back, turn No. 1 handle, and lean backwards and forward until the desired angle is achieved.
2. Slide adjustment
To move the seat forward and backward.
Pull No. 2 lever, forward and slide the seat.
3. Height(Tilting) adjustment.
Desired the seal height can be achieved by pulling No. 3 lever upward and downward.

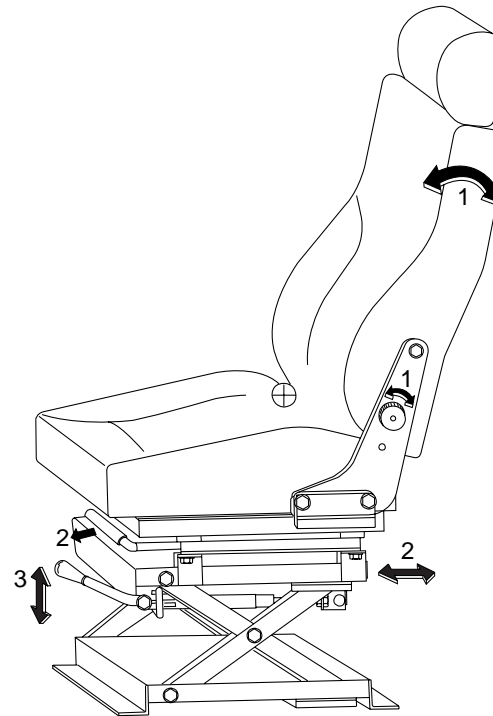

How to use non suspension seat

Semi suspension seat can be infinitely adjusted to suit the weight of the driver.

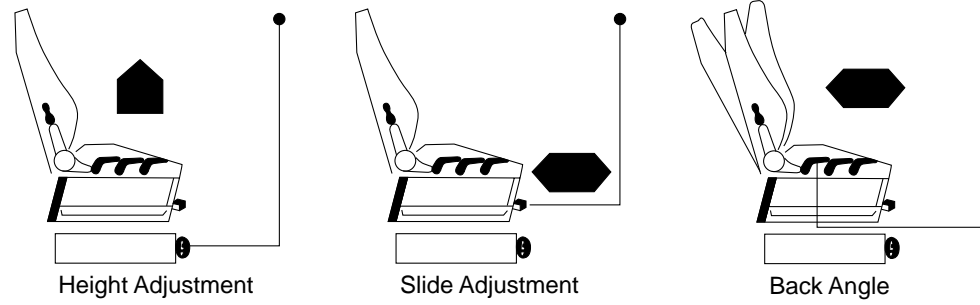

Adjustment of Air suspension type driver's seat (S-110A) (OPTION)

1. Slide adjustment
To move the seat forward or rearward, pull No. 1 lever upwards and then slide the seat.
2. Back angle adjustment
To adjust the seat back, pull No. 2 lever and lean backwards or forwards until the desired angle is achieved.
3. Height and slope adjustment
Desired seat height can be achieved by pulling No. 3 lever.
4. Upper lumbar support air cushion adjustment.
Lower button is for inflation, upper button is for deflation
5. Lower lumbar support air cushion adjustment.
Push the lumbar support air cushion adjustment button to suit seating position.
Lower button is for inflation, upper button is for deflation
6. Air suspension stroke support air undercushion adjustment
[Do not adjust the driver's seat while driving.]

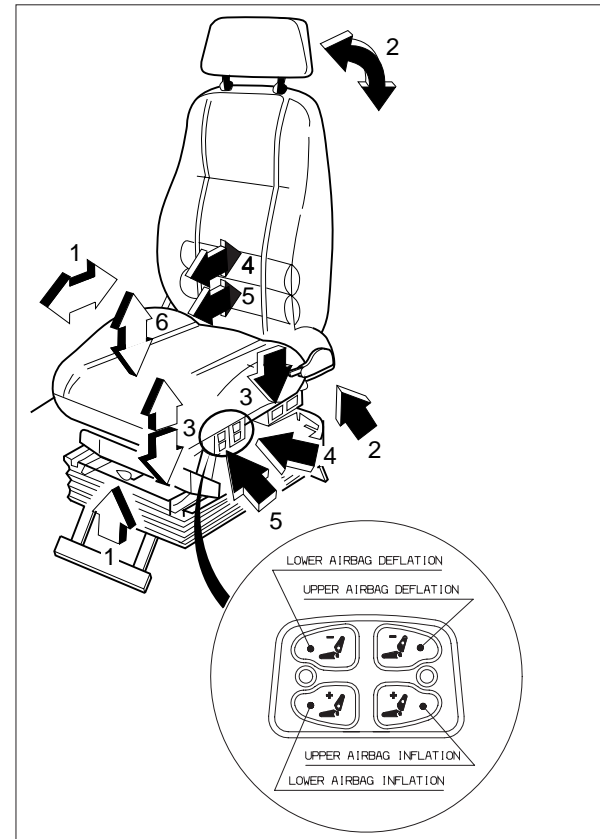

How to use air suspension seat

Air suspension seat can be infinitely adjusted to suit the weight of the driver.

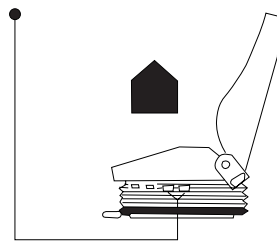

Height Adjustment

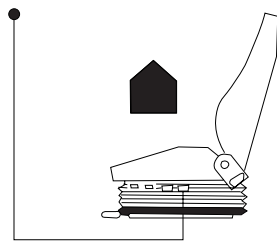

Tilt Adjustment(RR)

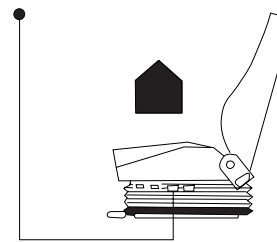

Tilt Adjustment(FRT)

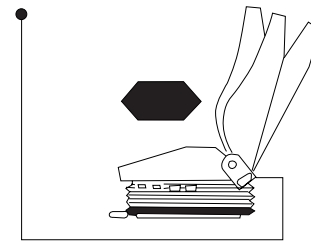

Back Angle

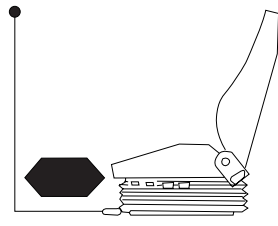

Slide Adjustment

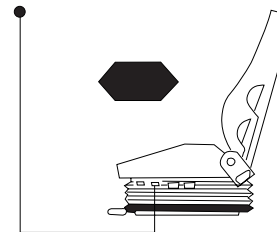

Lumbar Support(Upper)

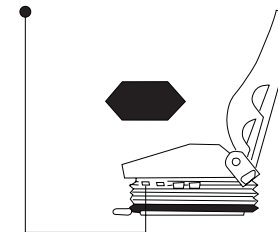

Lumbar Support(Lower)

Seat Belts

The vehicle is equipped with three point type(driver's) and reel type(passenger's)

Every person who drives or rides in this vehicle should wear a seat belt at all time.

The buzzer will sound, if the driver's seat belt is not fastened when the ignition switch is turned to the "ON" position.

- 1) Pull the belt evenly out of the retractor and guide it across the body making certain that it is not twisted.

The seatback should not be in a reclining position anymore than needed for comfort.

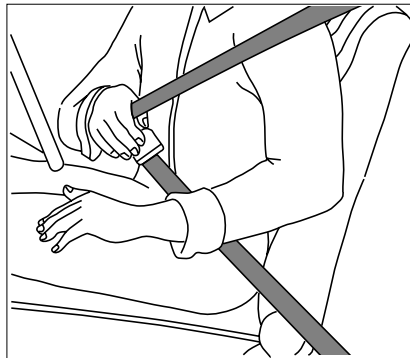

- 2) Insert the metal latch plate ① into the buckle ②.
- 3) To remove the belt, depress the red push button on the buckle.
And the belt will roll up automatically.
- 4) When the driver's seat belt is not in use, adjust the latch plate ① within 10cm from the seat loop.

The belt must not be twisted when fitted.

Do not wear the shoulder belt across the neck or under your outer arm.

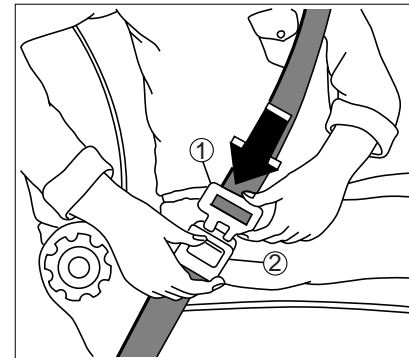

NOTICE

1. *Never use the belt for more than one person at a time.*
2. *Never wear the belts twisted.*
3. *Make sure seat belts or their attachments not to be thrust in metal parts of the seat or the door.*
4. *Seat belts should be adjusted as firmly as possible.*
5. *Do not wear seat belts low under your shoulder.*
6. *If you replace your seat belts incorrectly, you may be injured by hardware of the belts at sudden stops.*
7. *Do not wear your seat belts with hard or breakable objects such as glasses, pens, etc. put into the pocket of your upper garment.*

CAUTION

1. *Periodically inspect all parts of the belts and replace any damaged parts.*
2. *Make sure that the belts are not to be damaged by sharp edged objects.*
3. *The belts should be changed if webbing has become frayed or damaged.*
4. *Check if fixing bolts have been firmly installed to the floor.*
5. *Always keep the seat belts clean and dry.*
6. *Clean only with tepid soapy water.*
7. *Do not bleach or dye seat belts.*

INSTRUMENTS, SWITCHES AND CONTROLS

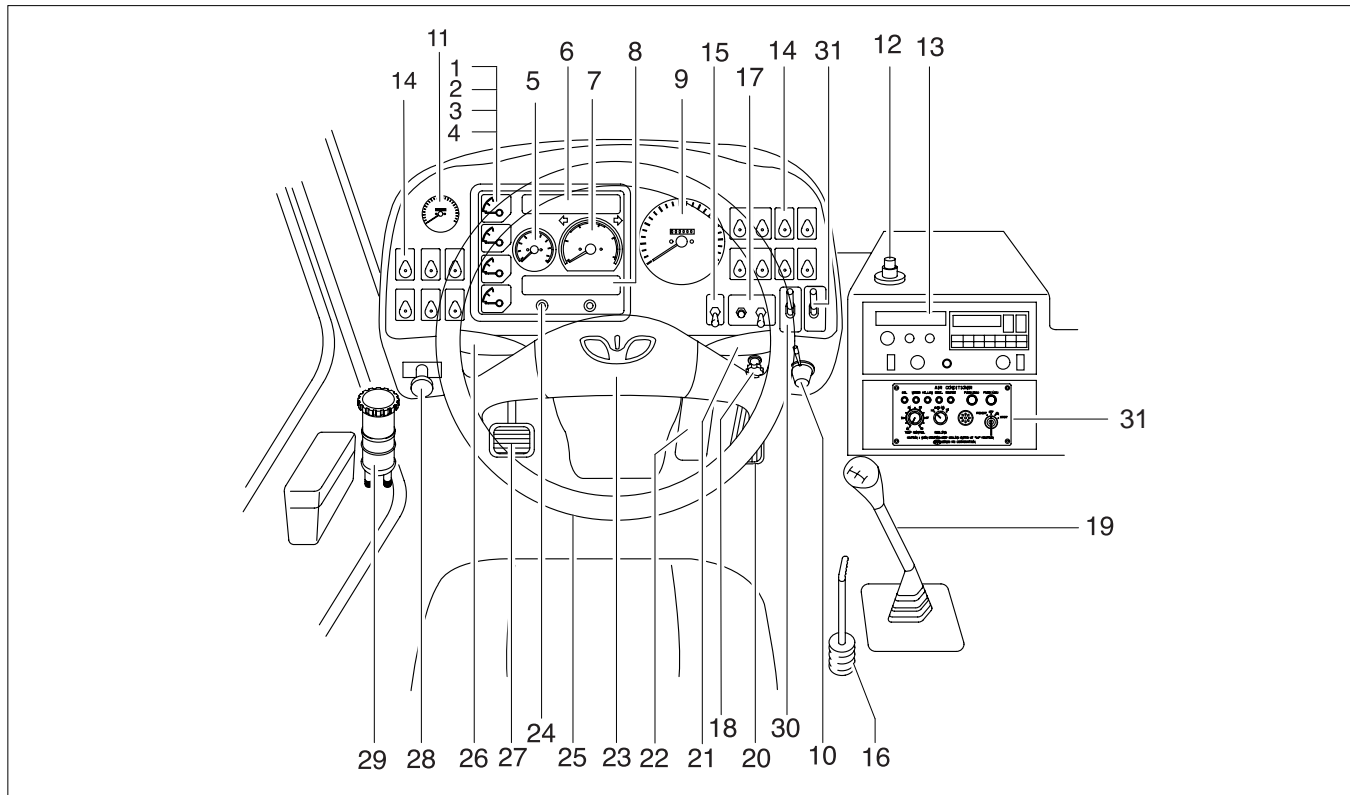

LEGEND OF INSTRUMENT PANEL AND OTHER DEVICES

No.	Description	No.	Description	No.	Description
1	Voltage meter	12	Microphone stand	22	Brake pedal
2	Engine coolant temperature gauge	13	Radio & Cassette player	23	Horn switch
3	Fuel gauge–Engine	14	Switches	24	Bulb check
4	Engine oil pressure	15	Battery OPEN/CLOSE switch	25	Steering wheel
5	Air pressure gauge	16	Parking brake lever (For AOH brake)	26	Head & Direction lamp lever
6	Upper pilot lamps	17	Rear wiper control switch(OPT)	27	Clutch pedal
7	Engine RPM gauge	18	Engine idling knob	28	Valve–cab control (For full air brake)
8	Lower pilot lamps	19	Shift lever (Except auto transmission)	29	Clutch oil tank
9	Tachograph (OPTION) Speedometer (OPTION)	20	Accelerator pedal	30	Warning lamp switch(OPTION)
10	Door opening switch (FRT)	21	Wiper control and exhaust brake lever	31	Sub cooler controller(OPT)

* The quantities or locations of switches could be different from the figure, because the switches could be added or omitted, or locations could be changed by the requirements of customers.

ATTACHMENTS OF STEERING COLUMN

Steering wheel and horn button

The steering wheel should not be turned while the vehicle is stationary as it adversely affects the tires and steering system.

Horn button is equipped on the middle of steering wheel.

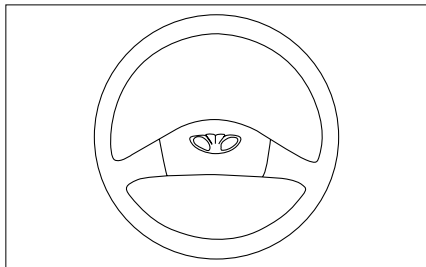

Steering wheel adjustment

Fixed type

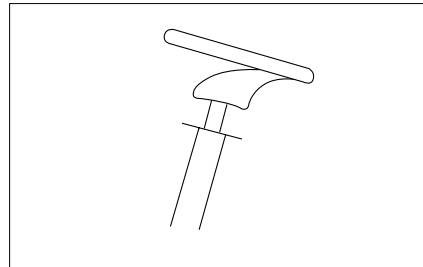

Starter switch

Starter switch operates in the 4 stages as follows :

- **LOCK** : The key can be inserted or removed only when the switch is in this position.
- **ACC** : This position turns on the radio, digital clock, cigarette lighter and consent.

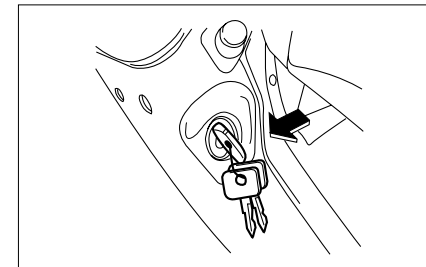

• **ON** : This position turns on the electrical equipment. During the vehicle operation, hold the key in this position.

* When the key is in "ON" position, the engine is automatically pre-heated according to outdoor temperature. Pre-heater warning lamp blinks for 0.3 second at a higher temperature (coolant temp. : above 25°C) and for 18 seconds at a lower temperature (coolant temp. : below 25°C), during which the engine is preheated for 20 seconds.

• **START** : Once the engine is started, it is preheated automatically according to outdoor temperature (until coolant temperature becomes 25°C or up to 6 minutes). This improves the engine condition.

CAUTION

- *Once the engine started, release the key immediately.*
- *Do not exceed 10 seconds for the operation of starter.*
- *Gearshift lever should be in neutral position when attempting to start the engine.*

Turn signal switch

Move this combination switch lever in the desired direction so that the corresponding turn signal lamp operates and causes the turn signal indicator lamp on the instrument panel to flash. The switch lever returns automatically to the neutral position when the steering wheel is returned to the reverse direction. When head lamp switch is in 2nd stage simultaneously with turn signal lamp "ON", cornering lamp also comes on.

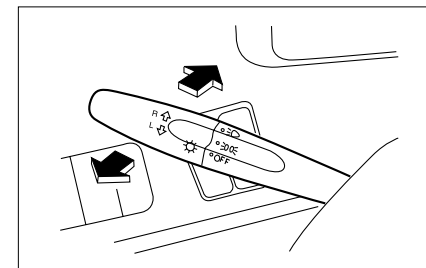
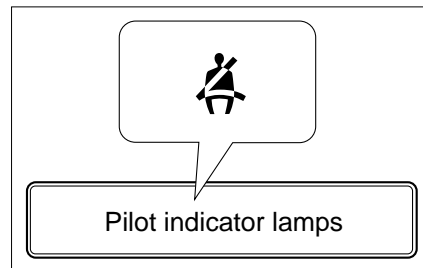
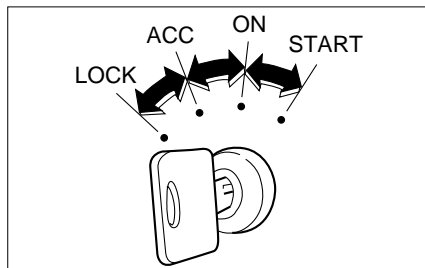

High beam switch

When the head lamps are on, pulling the lever down lights up not only the head lamps with high beam but also the high beam indicator lamp. When pulling it up, head lamps with low beam are on.

Passing lamp switch

To light up passing lamps at any time, pull up the lever towards the steering wheel.

The lever will return to the OFF position when released.

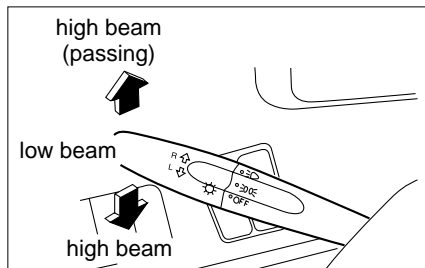

Lamp switch(turn type)

Lamp switch operates in two stages as follows :

1st stage : tail lamp, license plate lamp, instrument panel lamp, clearance lamp

2nd stage : tail lamp, license plate lamp, instrument panel lamp, clearance lamp, head lamp, cornering lamp(simultaneously with turn signal lamp "ON")

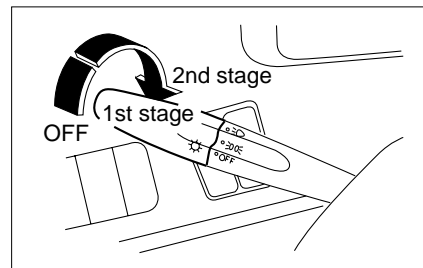

Windshield wiper switch

The windshield wiper switch has 3 positions to control the windshield wiper.

1. OFF = Off
2. INT = Intermittent wipe
3. LO = Continuous wipe, slow speed
4. HI = Continuous wipe, fast speed

NOTICE

Do not operate the wipers when the windshield remains dry. They may scratch the windshield glass. Do not operate the wipers if they are covered with snow or ice as this may damage the wiper system.

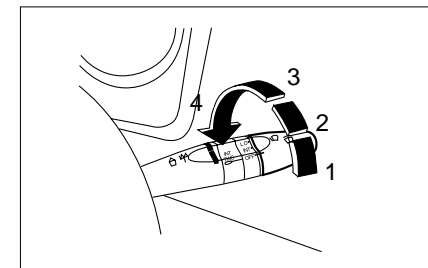

Wiper speed control switch

The desired intermittent operation time can be controlled by turning the knob when the wiper switch is in "INT" position.

Windshield washer switch

To let washer fluid spray on the windshield, press and hold the center button of switch.

And the windshield wipers are simultaneously operated for 2-3 cycles.

Exhaust brake switch

The exhaust brake system is designed to shut off exhaust pipe when the engine brake is applied, resulting in assisting brake action. When the switch lever is pushed downward, and clutch and accelerator pedals are released, the indicator lamp comes on showing that the exhaust brake is in operation. When the clutch and accelerator pedals are depressed, the exhaust brake stops working.

Hazard warning flasher switch

When the right-hand lever is pushed upward, all the turn signal lamps are made to flash regardless of the turn signal switch position.

The hazard warning flasher switch is to be used when your vehicle gets in a traffic hazard or is parked in the darkness.

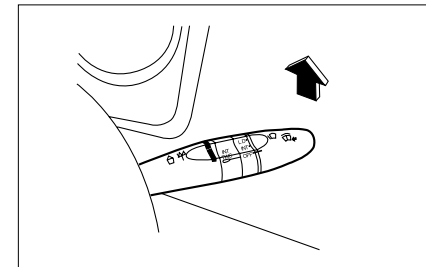
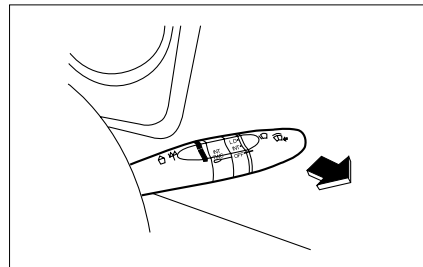
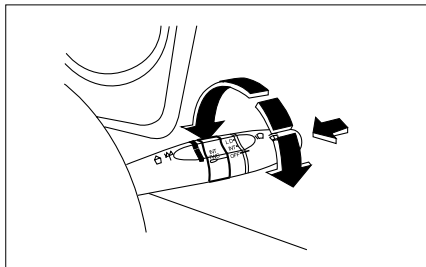

PERIPHERAL DEVICES OF STEERING COLUMN

Idle control knob

Turning the knob clockwise after cold starting of the engine will increase idling speed and thus facilitate quick normalization of the engine coolant temperature.

Always drive with the knob turned back home.

NOTICE

Do not use this knob to stop the engine.

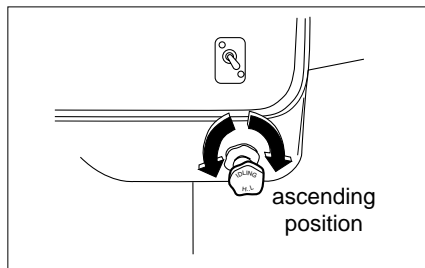

Battery switch

It controls the entire electrical circuits with the exception of parking lamps, hazard warning flashers. The electrical circuits are energized when the battery main switch is pressed.

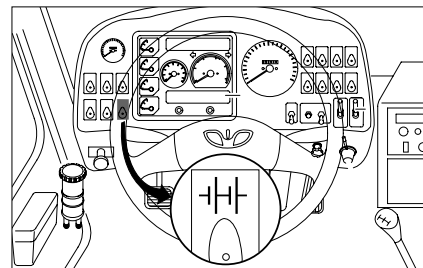

Rear wiper switch (OPTION)

- Washer push button (1)
push (ON) : To wash clean the rear glass.
- Rear wipers operation lever (2)
LOW (UP) : Wipers move at intervals of two point four seconds(25cycle/min)
INT (DOWN) : Wipers move at intervals of four seconds(15cycle/min)

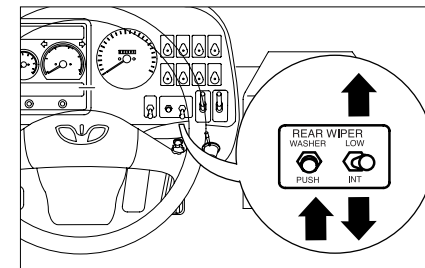

Front door control switch

The front door are operated by the air cylinder as the door opening switch on.

OPEN (RIGHT) : door open

CLOSE (LEFT) : door close

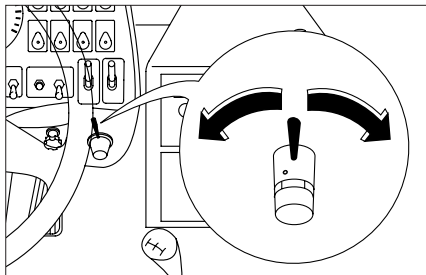

Air parking brake switch (OPT) (For full air brake)

When the switch is pushed, the parking brake is actuated and the indicator lamp comes on pushed one more the switch, releases the brake. Make sure that the indicator lamp is off before driving off.

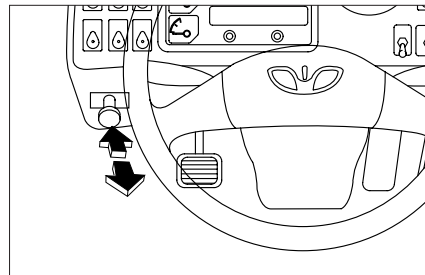

MID. or rear door control switch (OPT)

The middle or rear doors are operated by the air cylinders as the door opening switches on.

OPEN (down) : door open

CLOSE (up) : door close

* The quantities or locations of switches could be different from figure.

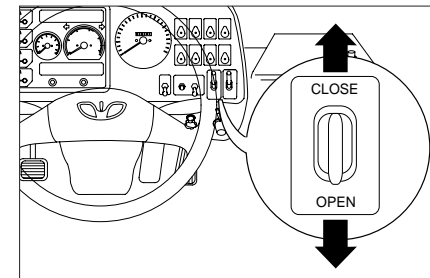

Stop arm control switch (OPT)

Raise the toggle switch position "ON"
Stop arm is operating voluntary by driver which have no relation with door opening then, warning lamps (Red) on roof comes on with blinker.

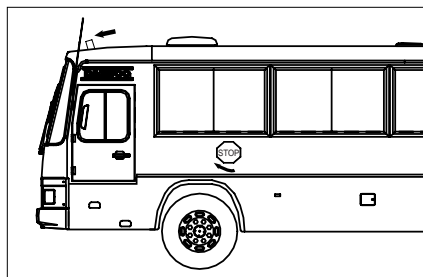
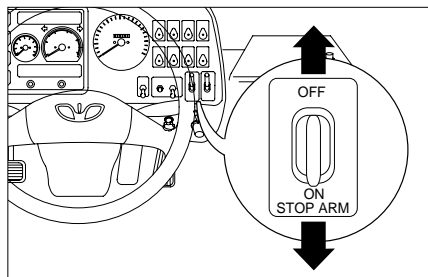
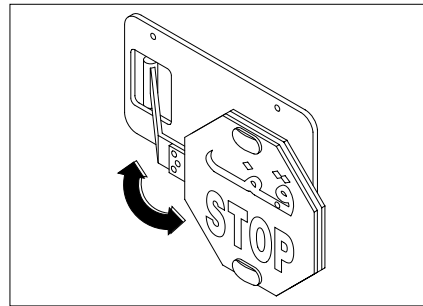

Warning lamp switch (OPTION)

Raise the toggle switch position "ON"
Warning lamps(Yellow) on roof comes on but, if stop arm switch is operated, yellow lamps come off, and Red lamps comes on.

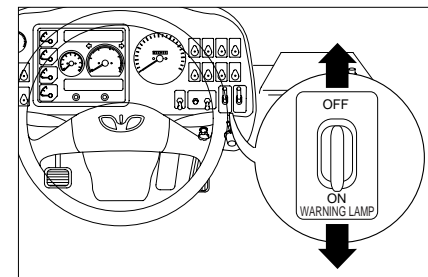

INSTRUMENTS AND INDICATOR LAMPS

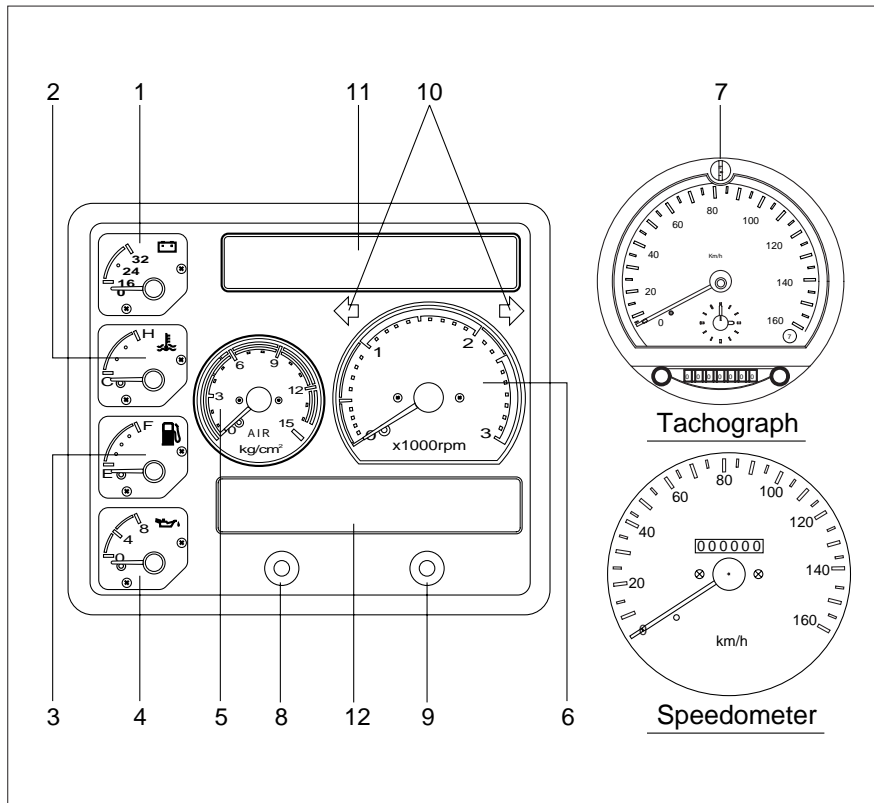

1. Voltmeter
2. Engine coolant temperature gauge
3. Fuel gauge
4. Engine oil pressure gauge
5. Air pressure gauge
6. Engine tachometer
(If the engine RPM indicating function is included in tachograph, this gauge is substituted by blank cover.)
7. Tachograph (OPTION)
Speedometer
8. Bulb check switch
9. Cover
10. Turn signal/hazard warning indicator
11. Upper pilot indicator lamps
12. Lower pilot indicator lamps

Voltmeter

The voltmeter indicates the battery condition. Check the voltmeter reading with the engine running. The gauge needle should stand between the reading of 24 and 28.

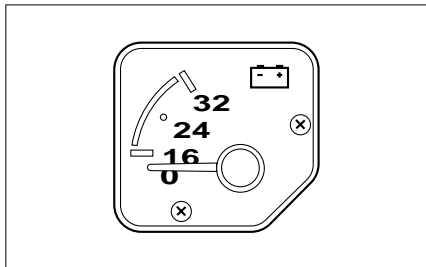

Temperature gauge

The gauge indicates the engine coolant temperature. If the gauge needle stands below the red colored zone, it means that engine coolant temperature is normal.

If the needle stands in "H"(overheating), stop the vehicle and run the engine at a moderately fast idle speed or put the gear in lower position to reduce engine load. If the vehicle is operated in abnormal condition, engine performance will be reduced and fuel consumption will be increased.

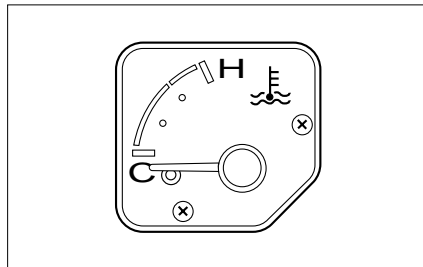

Fuel gauge

This gauge indicates fuel level of the fuel tank all the time regardless of the starter switch position.

The capital letter "E" represents almost "empty". Top-up the fuel tank before the gauge indicates "E".

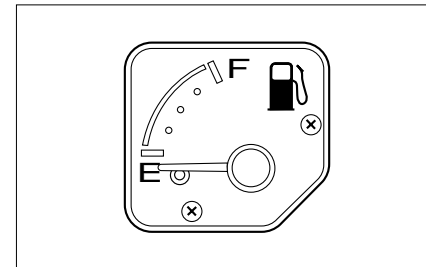

Oil pressure gauge

This gauge indicates oil pressure in the engine lubricating system. The indication of the gauge should be 1–3 kg/cm² when the engine is at idle ; it should be 3–6.5kg/cm² when the engine is running at medium speed. When the gauge needle does not move upward at all or hydraulic pressure changes abruptly, check the oil level in the engine crankcase. If the oil level is found normal, have the hydraulic system checked by your nearest Daewoo dealer.

Do not run the engine with low oil pressure indication.

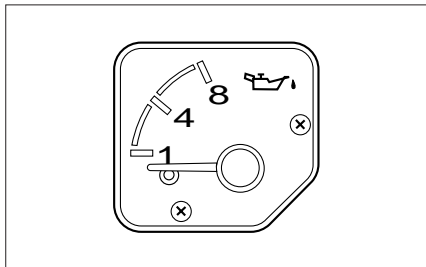

Air pressure gauge

Air pressure gauge indicates air pressure in the air tanks. While driving, the gauge needle must be within the range of 5.3–8.2kg/cm².

Be habitual of watching the gauge, while driving, to make sure the gauge needle indicates the normal conditions.

NOTICE

If the gauge needle stands in the red zone, warning lamp comes on and alarm buzzer sounds. Immediately stop the vehicle, check for unusual conditions, run the engine at a moderately fast idle speed to increase air pressure, then drive off.

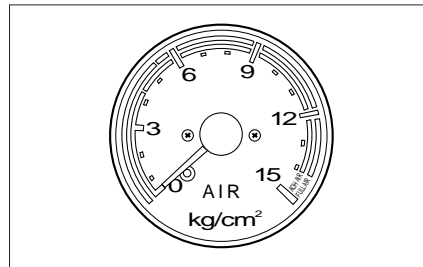

Engine tachometer

The tachometer indicates the engine speed in revolutions per minute(rpm) and red colored zone represents critical engine speed.

Excessively high engine rpm(red colored zone) may cause damage to the engine.

To drive economically, keep the engine within 1,000~2,000rpm.

Maximum allowable engine speed :
D1146 ENG : 2,500rpm.
DE12 ENG : 2,200rpm.
DE08TiS ENG : 2,300rpm.

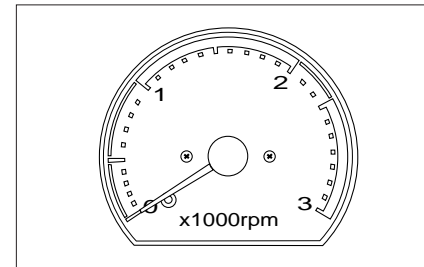

Tachograph(OPTION)

The tachograph is consisted of odometer and clock. The vehicle speed and running distances are registered in a single chart. The speedometer indicates the vehicle speed in kilometer per hour(km/h). The odometer indicates individual trip distances. The odometer records the total distance in km. The unit of registered distance is loom.

For further information refer to "TACHOGRAPH" on page.

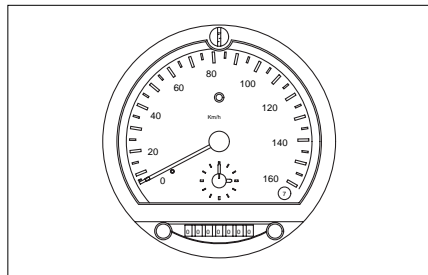

Speedometer

The speedometer is consisted of odometer and clock. The vehicle speed and running distances are registered in a single chart. The speedometer indicates the vehicle speed in kilometer per hour(km/h). The odometer indicates individual trip distances. The odometer records the total distance in km. The unit of registered distance is loom.

For further information refer to "SPEEDOMETER" on page.

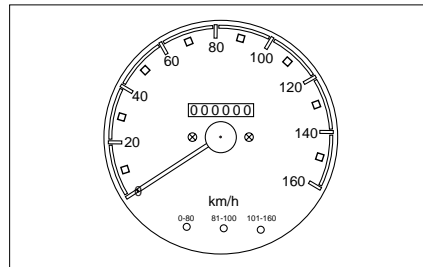

Bulb check switch

When bulb check switch is pressed, warning lamp on instrument panel comes on.

And also the warning buzzer sounds.

Before driving, use this switch to check that all warning lamps including speed indicator lamps and their circuits are operating normally.

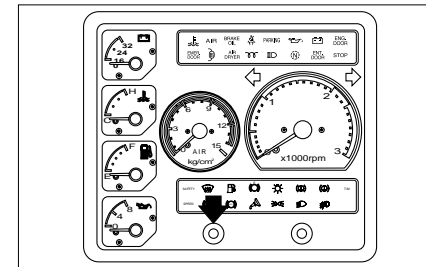

Turn signal indicator lamp

When the turn signal switch or hazard warning flasher switch is turned on, the turn signal indicator lamp flashes to indicate the operation of the external turn signal lamps or hazard warning flashers.

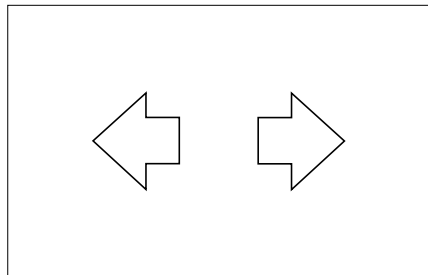

UPPER PILOT INDICATOR LAMPS

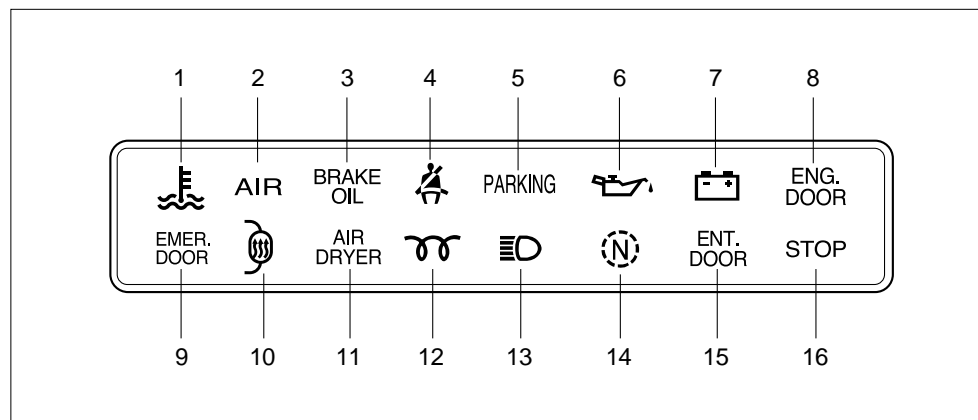

1. Engine coolant temperature (high)
2. Air tank pressure (low)
3. Brake oil level (low) (For AOH Brake)
4. Seat belt (Unfastened)
5. Parking lamp (on)
6. Engine oil pressure (low)
7. Battery charging
8. Engine door (open)
9. Emergency door (open) (OPTION)
10. Mirror defroster (on) (OPTION)
11. Air dryer operation (on) (OPTION)
12. Engine preheat (on)
13. High beam (on)
14. Transmission neutral position
15. Entrance door (open)
16. Passenger's stop order (OPTION)

Engine coolant temperature (high)

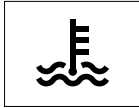

When the temperature of engine coolant becomes near 100°C (210°F) the warning lamp turns on.

Air tank pressure (low)



The indicator lamp comes on and the warning buzzer is operated simultaneously, when air pressure within the air tank is lowered to 5.3kg/cm².

If the air pressure indicator lamp comes on while driving, stop the vehicle and check to locate the cause of trouble and avoid driving with the indicator lamp turned on. Repeated application of service brakes could cause temporary lowering of air pressure. In such an instance, keep the engine running as fast idle until the indicator lamp goes out.

Seat belt (Unfastened)



The seat belt warning lamp comes on when the ignition switch is placed in the "ON" position unless the driver's seat belt is securely fastened.

Parking lamp (on)



The parking brake indicator lamp comes on when the parking brake lever is pulled with the starter switch "ON". The parking brake indicator lamp does not indicate the action of the parking brake. Make sure to pull the parking brake lever fully when parking the vehicle.



Before moving the vehicle, be sure to check that the parking brake indicator lamp is off.

Engine oil pressure (low)



The lamp comes on when the battery main switch is operated and goes out as the engine is started and pressure of oil in the engine is increased.

If the lamp comes on while driving, stop the engine immediately and check the level of oil in the engine crank-case. If the oil level is normal, restrictions in the oil filter or a trouble in the lubricating system may be indicated and the system should be checked at your nearest service station. Do not run the engine with the lamp illuminated.

Battery charging

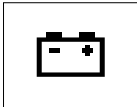

The indicator lamp comes on when the battery main switch is operated and goes out as the engine is started and alternator circuit is brought into normal function.

The indicator lamp comes on while the engine is running, it indicates that the alternator circuit is malfunctioning, then immediately stop the vehicle and have the alternator circuit checked by your nearest service shop.

Engine door (open)



ENG.
DOOR

The indicator lamp comes on when the engine room door is opened. If the lamp turns on even after closing the door, check the door lock and lock the door firmly

Emergency door (open)



EMER.
DOOR

The indicator lamp comes on when the emergency door is opened. If the lamp comes on even after closing the door, check the door lock and lock the door firmly..

Emergency door (open)



The indicator lamp comes on when the emergency door is opened. If the lamp comes on even after closing the door, check the door lock and lock the door firmly.

Mirror defroster (on) (OPTION)



Pressing the side mirror defroster switch, the indicator lamp "ON" and the defrosting coil in the mirror starts actuating.

Air dryer operation (on) (OPTION)



The indicator lamp comes on when the air dryer is operating.
(Air dryer heating system on)

Engine preheat (on) (OPTION)

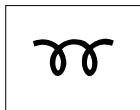

This lamp is designed to indicate preheating of the engine. It comes on when starter switch is positioned "ON", while it goes out when the preheating is completed.

High beam (on)

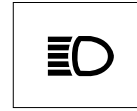

The high beam indicator lamp comes on when head lamps with high beam are in use.

Transmission neutral position



The indicator lamp comes on when the gear shift lever locates in neutral position.

Entrance door (open)



The lamp comes on while the entrance door is opened.

Passenger's stop order (OPTION)



When the passenger push the button between windows, the buzzer sounds and this lamp comes on.

Engine room fire warning (OPTION)



The indicator lamp comes on when the engine room is fired.

Retarder system warning (OPTION)



At the case that additional retarding system is applied, while the retarder is operating, the indicator lamp comes on.

LOWER PILOT INDICATOR LAMPS

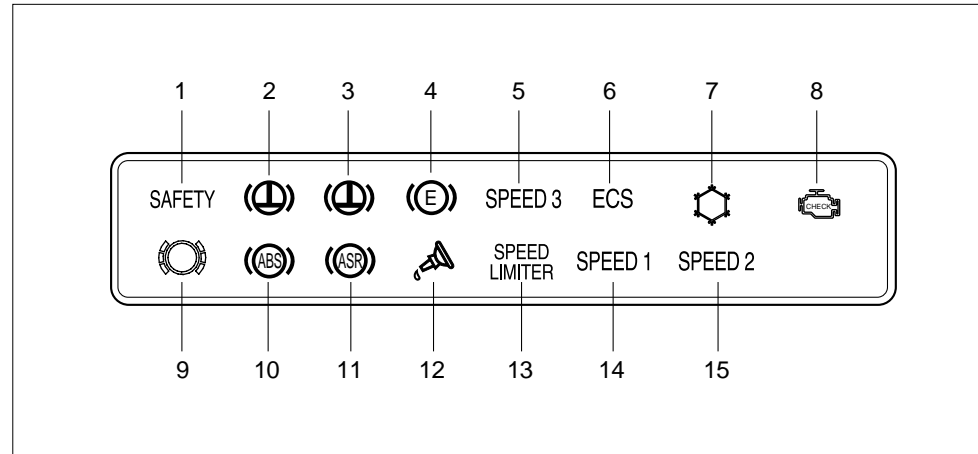

1. Safety equipment operation
2. Retarder system operation (OPTION)
3. Retarder system warning (OPTION)
4. Exhaust brake operation
5. Speed 3 indication (OPTION)
6. Electronically controlled air Suspension operation (OPTION)
7. Air condition warning (OPTION)
8. MIL
9. Brake pad wear warning
10. ABS system warning (OPTION)
11. ASR system warning (OPTION)
12. Auto greaser operation (OPTION)
13. Speed limiter operation (OPTION)
14. Speed 1 indication (OPTION)
15. Speed 2 indication (OPTION)

Safety equipment operation (OPTION)

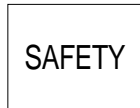

When the passenger stands at entrance step, the rear door is not closed, this lamp comes on.

Retarder system operation (OPTION)



For automatic transmission, while the retarder is operating, the indicator lamp comes on.

Retarder system warning (OPTION)



At the case that additional retarding system is applied, while the retarder is operating, the indicator lamp comes on.

Exhaust brake operation



The indicator lamp comes on while the exhaust brake is operating.

Electronically controlled air suspension operation (OPTION)

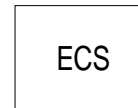

The height of the body is controlled automatically in accordance with the weight and speed of the vehicle, the lamps comes on when the system is operating.

Speed 1 indication (OPTION)

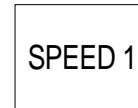

At the vehicle speed in 0~5km/H the lamp comes on, also the left Yellow-Green marker lamp on the roof at the front of the vehicle, lights on.

Speed 3 indication (OPTION)

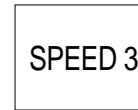

At the vehicle speed in 0~5km/H the lamp comes on, also the left Yellow-Green marker lamp on the roof at the front of the vehicle, lights on.

Speed 2 indication (OPTION)

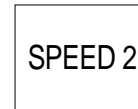

At the vehicle speed in 80km/H the lamp comes on, also the middle red marker lamp on the roof at the front of the vehicle, lights on.

Brake pad wear warning (NOT USE)

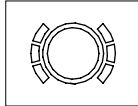

The indicator lamp comes on when the brake lining is too much worn out.

ABS system warning (OPTION)



As the battery relay and the starter switches are turned on, the indicator lamp comes on and goes out when the vehicle speed reach to 5~10km/H. If the lamp keeps lighting while driving, the ABS/ARS system is out of order and should be checked.

NOTICE

When the ABS/ASR system is out of order, the brake system works as if ABS system is not applied.

ASR system warning (OPTION)



As the battery relay and the starter switches are turned on, the indicator lamp comes on and goes out in a short time. If the lamp keeps lighting while driving, the ASR system is out of order and should be checked.

Auto greaser operation (OPTION)



The indicator lamp comes on while the auto greasing system is operating or the main pressure of the system drops below 25kg/mm².

Speed limiter operation (OPTION)



The lamp comes on while the speed limiter system is operating.

Air conditioner warning (NOT USE)

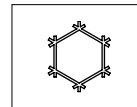

The lamp comes on when the high/low voltage is flowing or the compressor clutch is disconnected, etc.

Engine malfunction lamp (NOT USE)

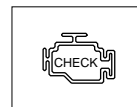

Check the state of engine operating when starter key on.

This lamp flashes at engine cranking in normal of engine operating.

Otherwise, on abnormal of Engine operating, lamp come on continuously and come on during of engine running.

SWITCHES

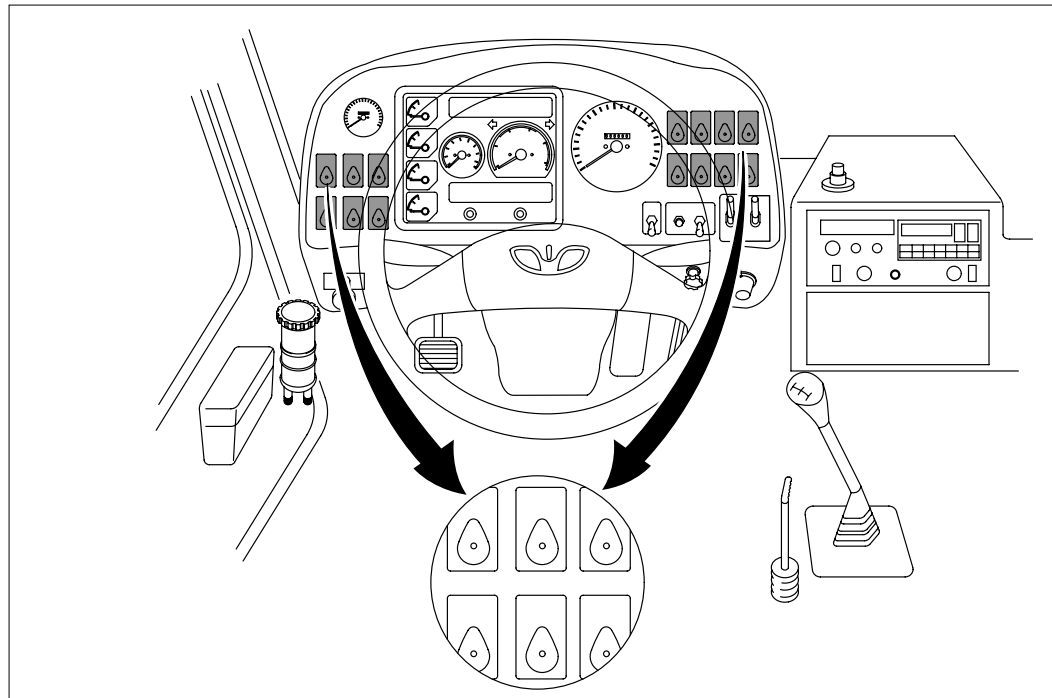

★ The quantities or locations of switches could be different from the figure, because the switches could be added or omitted, and locations could be changed by the requirement of customers.

Room lamp switch (Floor 1)

Push the switch to light on the first room lamp (incandescent) from the entrance door (Front).

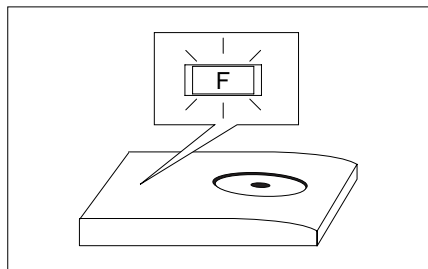

Room lamp switch (Floor 2)

Push the switch, light come on the all room lamp (incandescent) but except first room lamp at the entrance door (Front).

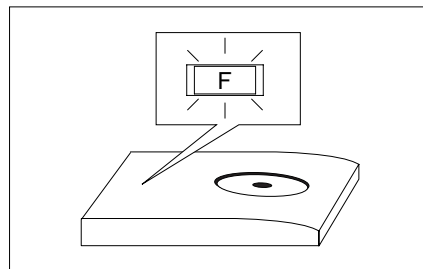

Room lamp switch (Bulb)

Push the switch to light on the fluorescent room lamps at the passenger's compartment.

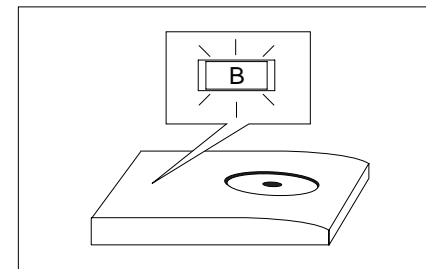

Driver lamp switch

Pressing the switch, the driver's compartment lamp comes on.

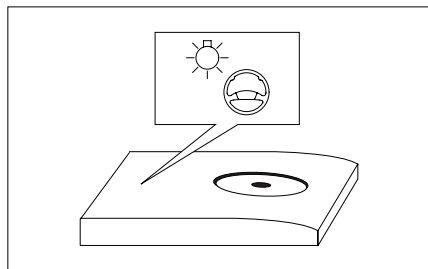
**Fog lamp switch (Front)**

Pressing the switch, the fog lamps come on to improve your Forward/backward vision in fog or snow.

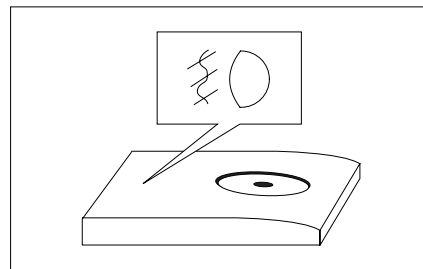
**Fog lamp switch(Rear) (OPTION)**

Pressing the switch, the fog lamps come on to improve your Backward vision in fog or snow.

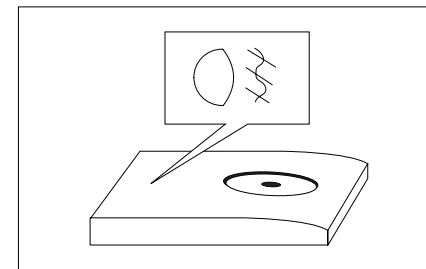

Battery main switch

Pressing the switch to light on the battery lamp come on.

Parking lamp switch (OPTION)

Pressing the switch to light on the parking lamp lamp come on.

Reading lamp switch (OPTION)

Pressing the switch, reading lamps below the air-conditioner grill come on.

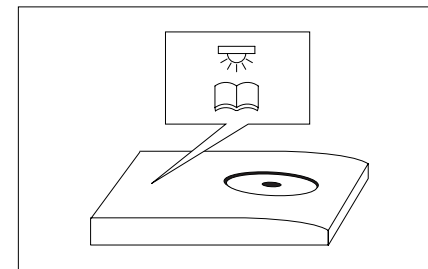
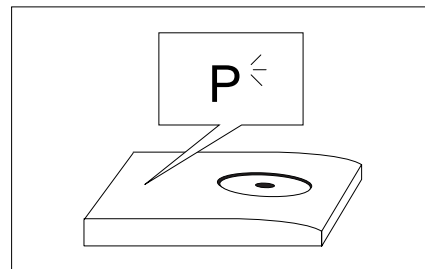
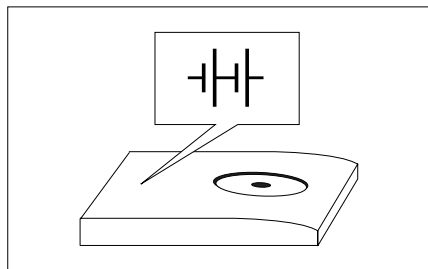

Stop arm switch (OPTION)

Push the this button, the stop arm is operated automatically when door is opening and warning lamps(Red) on roof comes on with blinker

Destination board switch (OPT)

Push the switch to light on the destination boards front and rear.

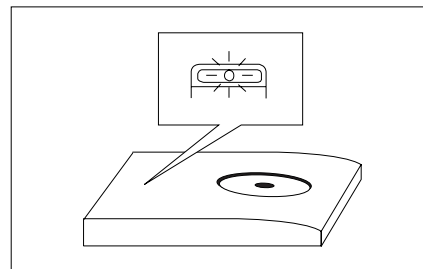
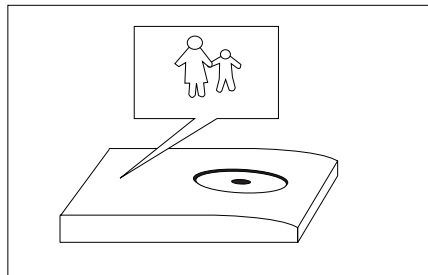

HEATING AND DEFROSTING

Heating and defrosting of driver's compartment

Power on by moving the control lever to upper or lower and control the speed of blower fan, the indicator lamp comes on when the lever moved upper or lower when the lever reaches to the upper, the blower fan start to operate powerfully, otherwise reaches to the lower, fan's speed is slowly the lever reaches to the center, the defroster's power is off.

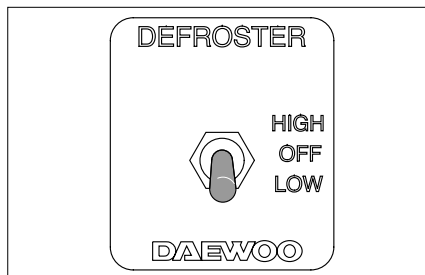

Heating of passenger's compartment (OPTION)

Shift the toggle switch "High" or "Low" position of the heater control panel to operate the blower fan of each heater placed below the passenger's seat, then the air in the compartment will be warmed by circulation. By the requirement of customer, the quantity of the heaters will be added or omitted.

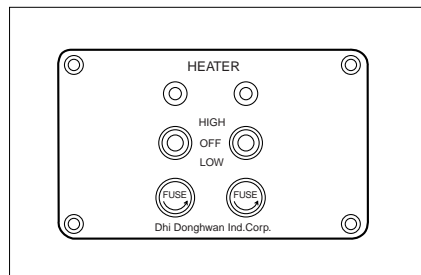

AIR CONDITIONING COOLER (SUB ENG. TYPE) (OPTION)

1. Operation

- (1) Confirm the selector switch at "L" position.
- (2) Turn the key switch (counterclockwise) to "PREHEAT" position in order to heat the glow plugs with the engine for approximately 20 seconds.
- (3) Set the key switch to "ON" position, and make sure that the oil pressure lamp is lighted for a bulb check.
- (4) Then, turn the key switch (clockwise) to "START" position. The sub-engine will be driven by starter motor.

Note : *If not starting the sub-engine after. Running the starter motor for 20 seconds, try to restart the sub-engine by doing the above mentioned process "(1)" to "(4)" after one minutes.*

- (5) Release your hand from the key switch after starting the sbu-engine. The sub-engine runs at low speed and the bus air conditioner is just operated.

Note : *The key switch should be remained with "ON" position while operating the bus air conditioner.*

2. Control panel

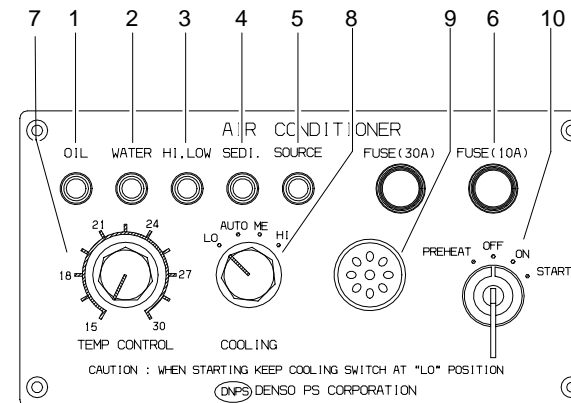

- | | |
|---------------------------|------------------------|
| 1. Oil pressure lamp | 6. Fuse box |
| 2. Water temperature lamp | 7. Temp control switch |
| 3. High/Low pressure lamp | 8. Selector switch |
| 4. Sediment lamp | 9. Glow pilot |
| 5. Power lamp | 10. Key switch |

3. Stopping

(1) Normal stopping

Turn the key switch "OFF" position, when you want to stop the engine.

(2) Emergency stopping

The GB·220SK air conditioning system provides the safety functions to stop automatically its operation under the following emergent conditions.

- a. When the refrigerant pressure of the bus air conditioner system may deviate abnormally from specified limit.
- b. When the coolant temperature of the engine may reach to the temperature of possible engine overheating.

4. Refrigerant system

Use of refrigerant R-12 in this system cools the air in the bus with evaporation of the refrigerant. The evaporated refrigerant is fed into condenser after compressed at high pressure and high temperature by compressor for repeated use.

Condenser fan converts the refrigerant into liquid at high pressure and high temperature by cooling. Use of expansion valve cause the liquid refrigerant to be decompressed, to enter the cooler again, and to evaporate to cool down the air in the bus.

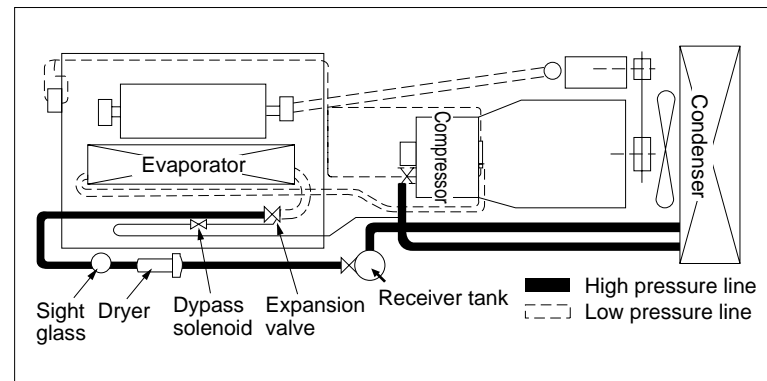
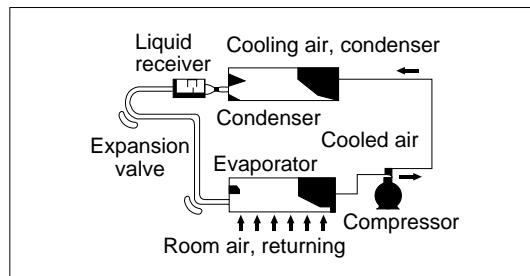

5. Sub engine driving system

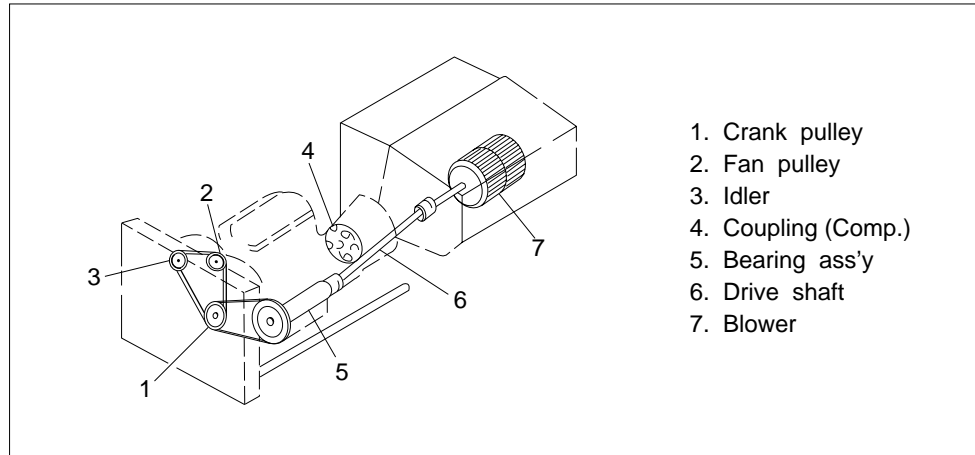

Condenser fan is driven by V-belt, and evaporator fan by driving shaft.

6. Cooling air circulating system

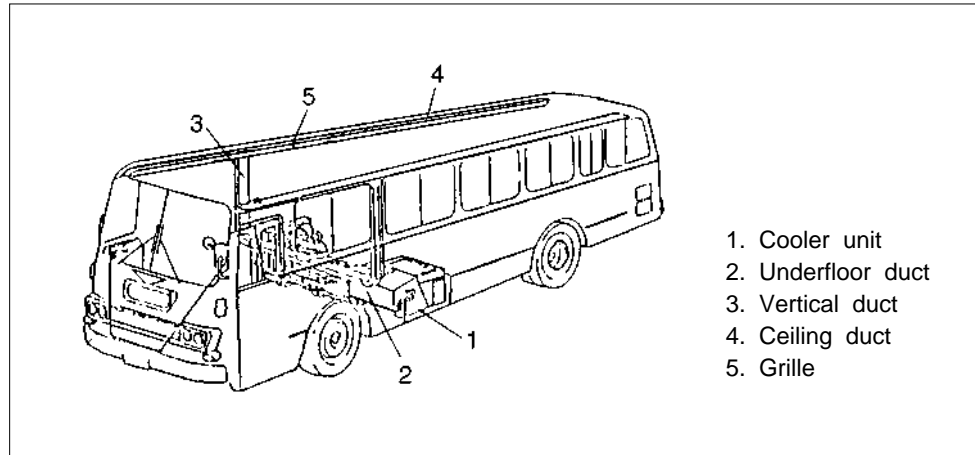

Cooler blows off cooled air through the blow off grilles on the ceiling.

AUTOMATIC VENTILATOR (OPTION)

Exhaust

Set the knob to "Exhaust" to open the shutter and extract the air in the compartment to outdoor.

Suction

Set the knob to "suction" to open the shutter and intake the outdoor air to the compartment.

Circulation

Set the knob to circulation, then the blowing fan repeat Exhaust and suction by changing the rotating directions.

Ventilation

Set the knob to "Ventilation", then the shutter opens only, the air is ventilated by natural.

(1EA) (OPTION)

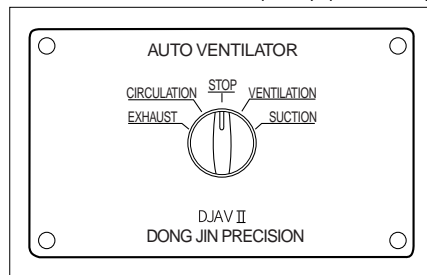

(2EA) (OPTION)

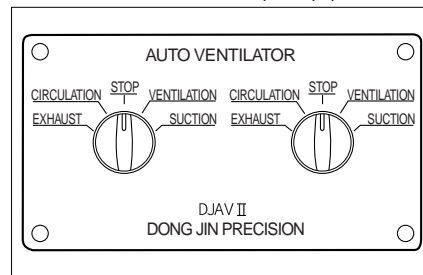

PREHEATER (OPTION)

Preheater operation

1. In the case that the ambient temperature is below 0°C, set the control knob to the "PREHEAT" position about 20 seconds for preheating the fuel nozzle, then shift the knob to "ignite" position. (Preheat indicating lamp comes on when the preheating of fuel nozzle is finished, the time of indicating lamp coming on is different by ambient temperature. The preheat temperature is about 30°C.)

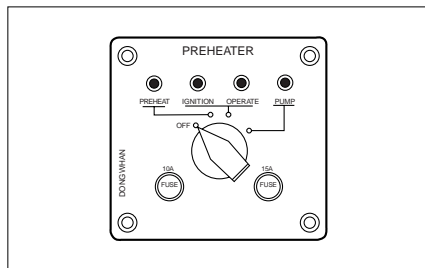

2. By setting the control knob to the "ignite" position, the indicating lamps "ignite" and "pump" come on. Also "drive motor" and "Water pump motor" start operating. By the drive motor operating, the blowing fan and fuel pump work together.
3. Within 15~30 seconds after operating of "drive motor" and "water pump motor", the solenoid valve is opened and fuel injection starts. At the same time electric discharge starts between the electrodes by high current. Then the injected fuel is ignited and combustion starts. The indicating lamp "operate" comes on).
4. After ignition, flame defector check the condition of combustion and stops the electric discharge between electrodes.
5. When the temperature of coolant reaches to 75°C, after normal combustion, the solenoid valve stops fuel injection by the thermo sensor and the "ignite" indicating lamp goes out. After stop of combustion, the drive motor operates 150~180 seconds more, and stops but the water pump motor continues operating. (The indicating lamps "operate", "pump" keep lighting on).
6. At the condition of paragraph 5, when the coolant temperature drops below 65°C), the sequence from paragraph 2~4 repeats automatically and the heating of coolant is maintained.

-
7. To stop the operation of preheater, set the control knob at "stop" position, then the combustion stops, but drive motor and water pump motor operate 150~180 seconds more, then stop.
 8. When the control knob is set to "pump" position, water pump motor operates only and the heating effect could be enhanced.
(When operating heaters, heat loss in the heating line decreases and "pump" indicating lamp comes on only).

Check point before operation

1. Fuel level : Replenish if the fuel level is low.
2. Filter if it is clogged.
3. Fuel feeding pipe and/fittings.
4. Hot water circulation valve in the engine side is open.
5. Suction and exhaust pipe are clean.
6. Coolant level of the engine.

Maintenance

1. Periodically clean fuel filter element.
2. If required clean inside heat exchanger and remove dirt and carbon by brush and water. It will longer the service life.
3. For operating efficiently, remove dirt, carbon of flame detector with soft and dry cloth, and sure not no damage C.D.S surface.
4. Take off nozzle from nozzle holder, and clean or exchange.
5. When operating on rough and unpaved road, be sure to clean intake and exhaust tube periodically for efficient use of blow motor.

Trouble shooting

Problem	Cause	Maintenance
Indicating lights "on" even switches are operated	<ol style="list-style-type: none"> 1. Cut of lamp 2. Fuse melted(F1 or F2) 	<ol style="list-style-type: none"> 1. Change 2. Change
Circulating pump doesn't operate	<ol style="list-style-type: none"> 1. Fuse melted(F1 or F2) 2. Water frozen 3. Impeller restricted by contamination in water flow line 	<ol style="list-style-type: none"> 1. Change 2. Heating or anti-freeze injection 3. Clean
Fuel pump operates, but fuel is not injected	<ol style="list-style-type: none"> 1. Lack of fuel 2. Fuel filter blocked or frozen by water 3. Leakage of fuel piping 4. Solenoid valve under quality 	<ol style="list-style-type: none"> 1. Refuel 2. Clean or change 3. Tightening 4. Change or overhaul repair
Fuel injected, but doesn't ignite	<ol style="list-style-type: none"> 1. Electrode under quality 2. Ignition unit under quality 3. Lack or excess of combustion air 	<ol style="list-style-type: none"> 1. Change or correct the position 2. Change 3. Clean air intake and exhaust tube, adjust damper.
Motor doesn't operate, even the switches are turned "on"	<ol style="list-style-type: none"> 1. Fuse melted(F1) 2. Fault or uncorrect wiring of electricals 	<ol style="list-style-type: none"> 1. Change 2. Inspection and repair

Problem	Cause	Maintenance
Fuel cut, bad combustion	<ol style="list-style-type: none"> 1. Not enough fuel supply by water and debris in fuel line 2. Leakage of fuel line 3. Lack of combustion air 4. Fuel pump under quality 5. Bad injection of burner nozzle 	<ol style="list-style-type: none"> 1~3. Pipe retightening, clean water, debris of intake, exhaust tube. 4. Change 5. Change or clean nozzle
Overheat of preheater body	<ol style="list-style-type: none"> 1. Heat exchanger water valve shut off 2. Air in water line or body 3. Big resistance in water flow 4. Lack of water flow by old water pump 5. Bad adjustment of overheat sensor setting 	<ol style="list-style-type: none"> 1. Open the valve 2. Bleed air 3. Inspection and repair of line 4. Change parts 5. Change
Abnormal shut off of combustion when operating	<ol style="list-style-type: none"> 1. Overheat by blocking in water flow or lack of water 	<ol style="list-style-type: none"> 1. Remove the cause of overheat, operate the push button of overheat sensor.

Sectional view

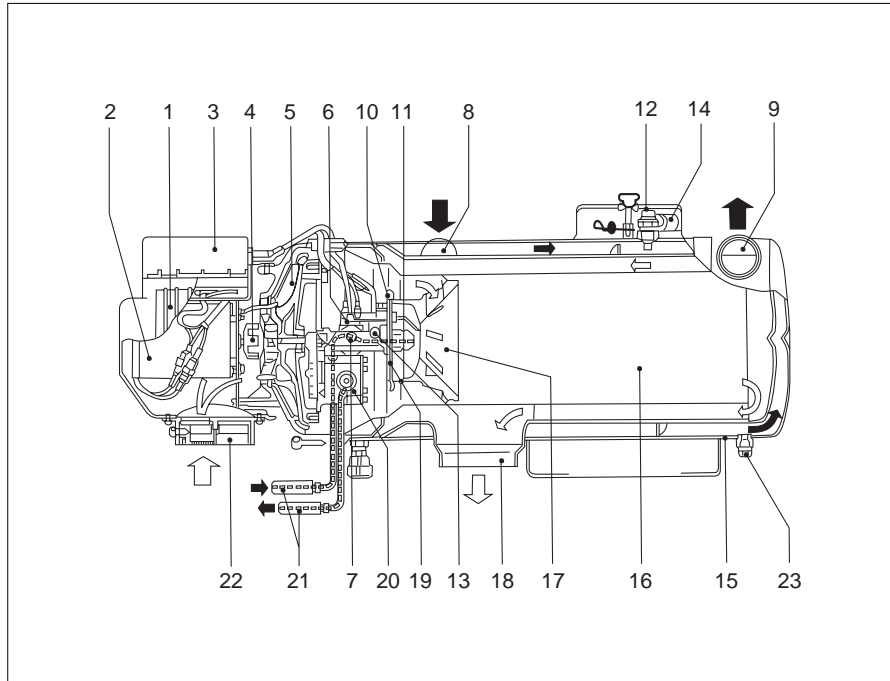

1. Control unit
2. Drive motor
3. Ignition unit
4. Coupling
5. Combustion air fan
6. Solenoid valve
7. Electrode plug
8. 9. Water pipes
10. Ignition electrodes
11. Fuel nozzle
12. Control thermostat
13. Preheat coil
14. Overheat thermostat
15. Heat exchanger
16. Combustion chamber
17. Air swirler
18. Exhaust pipe
19. Flame detection photocell
20. Fuel pump
21. Fuel pipe
22. Combustion air intake, socket
23. Drain bolt

RADIO AND CASSETTE TAPE PLAYER

<Without echo type-A> (OPTION)

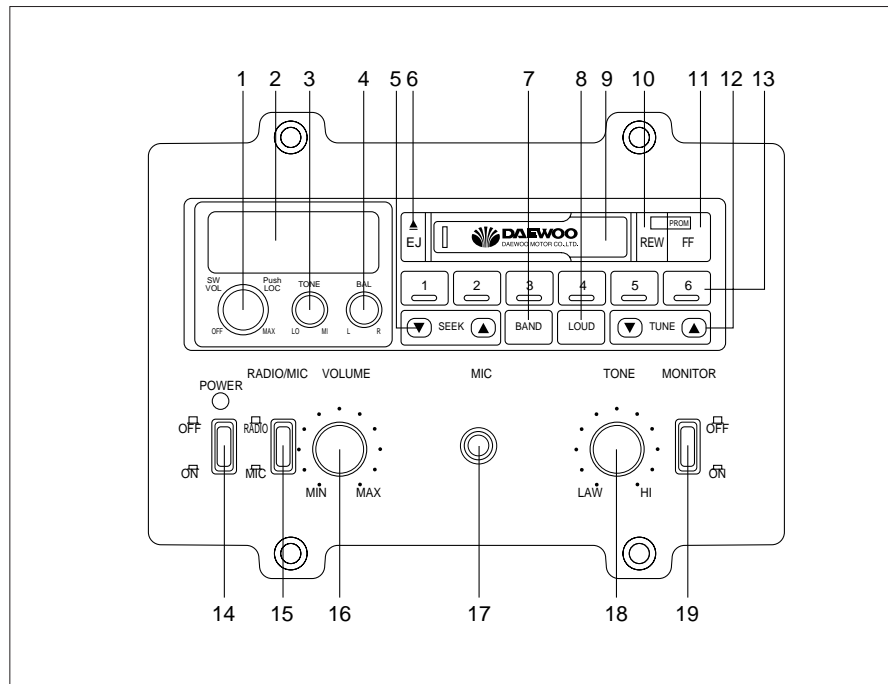

1. Radio/cassette ON/OFF, and volume knob
2. Indicator displaying the operating situation of Radio cassette tape player.
3. Radio/cassette tone knob
4. LEFT/RIGHT speaker balance knob
5. Seek button
6. Eject button
7. Band button
8. Loud button
9. Tape slot
10. Fast rewind/progress button
11. Fast forward/progress button
12. Tune Button
13. Preset buttons
14. Power switch
15. Radio/Mic change switch
16. MIC volume knob
17. MIC jack
18. MIC tone knob
19. Monitor switch

Radio operation

- Press power switch 14 to power on the system.
- Press Radio/MIC switch 15 to select the Radio/MIC operation.
- Turn Radio/cassette ON/OFF and volume knob clockwise to operate and control the volume, then the indicator starts displaying and each lamps of knobs and buttons come on simultaneously.
- Press band select button 7 to select AM/FM band.
- Press seek button 5, then the frequency is automatically increases or decreases and stops when any receivable frequency is sought.
(∇: decrease, Δ : increase)
- Keep pressing the tune button 12, then the frequency increases or decreases, when the needed frequency is received, release the button (∇: decrease, Δ : increase)
- Press present button 13 to receive the memoried frequency. Also, to memory any frequencies on preset buttons, while the needed frequency

- is being received, keep pressing preset buttons more than 2 seconds.
- Turn the tone knob 3 to control the strength of high sound.
- Turn th balance knob 4 to balance the sounds of left and right speakers.
- Press loud button 18 to enhance the low and high sound.
- When the receiving condition is not good because of high impedance, magnetic interference of etc, push power switch 14, then receiving condition can be enhanced and "LOC" is displayed in indicator.

Cassette operation

- Insert tape into the slot 9, then the radio stops and tape play back starts automatically.
- Keep pressing fast rewind/progress or fast forward/progress button 10, 11 to rewind or forward the tape fastly.
- Press fast rewind/progress and fast

- forward/progress buttons 10, 11 together, then the tape play back direction changes.
- Press eject button 6, then the tape play back is stopped and the tape is ejected through the tape slot.
- Tone, balance and loudness controls are same as radio operation.

MIC operation

- Insert mail type jack of microphone into MIC jack 17.
- Press RADIO/MIC switch 15 to select the Radio/MIC operation.
- Turn mic volume knob 16 to control the volume of MIC sound.
- Turn mic tone knob 18 to control the tone of MIC sound.

<Without echo type-B> (OPTION)

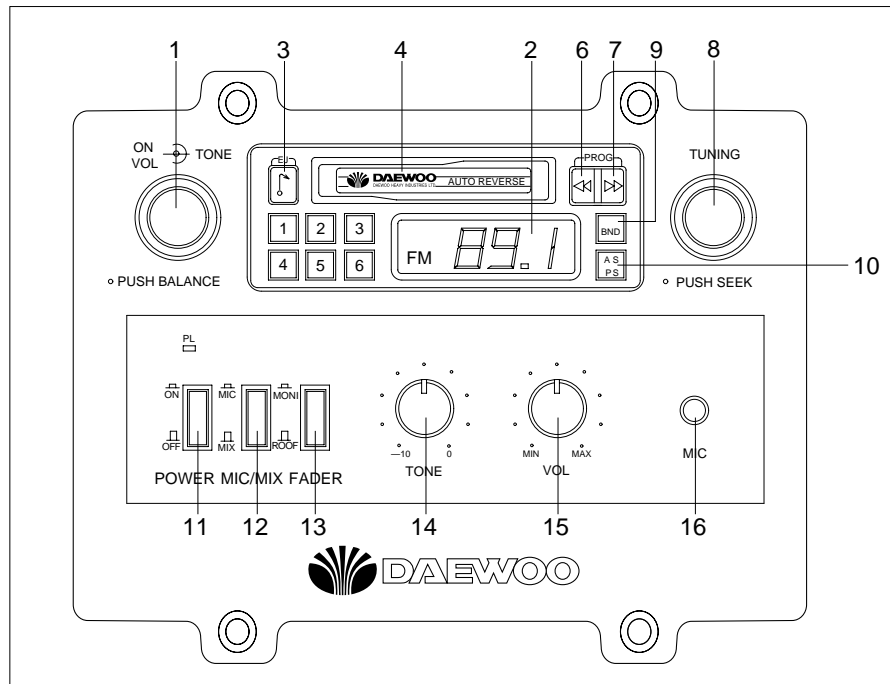

1. Power ON/OFF and balance (Tone/volumn)
2. LCD display
3. Eject button
4. Tape slot
5. Broadcasting remember button
6. Fast forward button
7. Fast rewind button
8. Seek knob
9. Band
10. AS/PS button
11. MIC Power switch
12. MIC/Radio fader
13. Monitor fader
14. MIC tone knob
15. MIC volume knob
16. MIC jack

Radio operation

Push the knob(1) control the balance fittingly and control the volume knob(1).

Push the band button(9), select the FM/AM affirmed indicator.

Select board casting turning the knob(8) manually, or automatically boardcasting lony push the AS/PS button(10) more 2 seconds.

- TUNING : Turning the knob(8) to enhance the low and high sound.
- PUSH SEEK : Received the board-casting automatically by pushing the button once or more.
- AS/PS : Pushed the button(10) more 2 seconds longly, search the band automatically and remember the 1st ~ 6th boardcasting but, shortly push the button, searched the boardcasting in memory once more push the this button stop the searching.

Each remembered the boardcasting in button(5), 18th boardcasting is remembered on AM1, FM1, FM2 each button.

Controlled the high volume by turning the knob(1).

Turn on the power, controlled volume and balance and the AMP volume like to RADIO operation insert tape in to the slot(4), then tape play starts automatically.

Press the button(6, 7) to rewind or forward the tape fastly and inverted direction of playing the tape.

Direction of play displayed the indicator(2) press the eject button(3), tape is ejected through tape slot.

Don't eject during tape playing

Cassette tape player

Turn on power(1) by turning to knob to right(In state of main power is on of AMP lifier)

Controlled the volume, balance and AMP volume replayed the sound by inserting the tape on tape slot(4) press the button(6, 7). Tape is Reward/Forward fastly press the button(7) tape direction is automatically reverse at time and indicator lamp(2) light comes on.

Controlled the right/low tone by turing the knob(1) press the eject button(3) tape is ejected through tape slot.

MIC operation

- Insert mail type jack of microphone into MIC jack(16).
- Press RADIO/MIC switch(12) to select the Radio/MIC operation.
- Turn mic volume knob(15) to control the volume of MIC sound.
- Turn mic tone knob(14) to control the tone of MIC sound.
- Press the monitor fader button(13) in case of installation of monitor on side driver, controlled driver's monitor or roof speaker.

<MIC AMP. type> (OPTION)

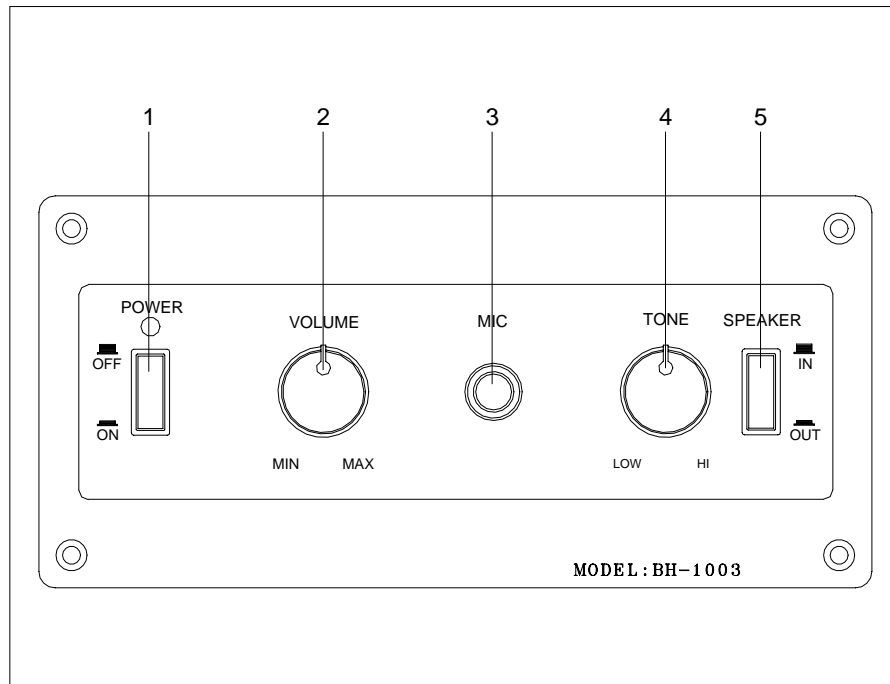

1. Power switch
2. MIC. volume knob
3. MIC. jack
4. MIC. tone knob
5. Speaker IN/OUT switch

MIC operation

- Press power switch 1 to power on the system.
- Insert mail type jack of microphone into MIC jack 3.
- Turn mic volume knob 2 to control the volume of MIC sound.
- Turn mic tone knob 4 to control the tone of MIC sound.
- Press speaker switch 5 to convert the sounds of IN/OUT speakers.

PRECAUTION IN DRIVING

Safety Driving and Parking

1. For safety driving, turn down volume, sufficiently.(To hear signal sound of horn.)
2. Over a period of time, direct sun light can cause the speaker or tape set to become malfunction, ventilate the air in the cab before operation.

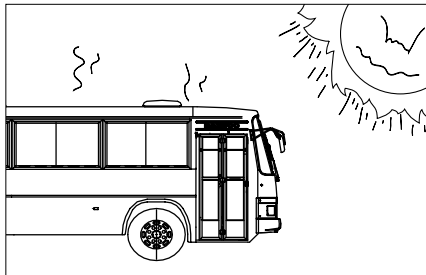

Cassette Handling Precaution

1. To clean the surface or body cassette with a cotton applicator. Don't use benzene, thinner, solvent.
2. Be careful that the cassettes are not exposed to magnetic fields or not abrasive to other metal parts.
3. Keep speakers, tapes and radio not to be wet when cleaning the vehicle and be careful not to be exposed to moisture to protect electrical shock.
4. Cassettes are negative ground type and the power source is DC 24V.
5. Be careful not to repair by unskilled person because cassettes are precise parts.

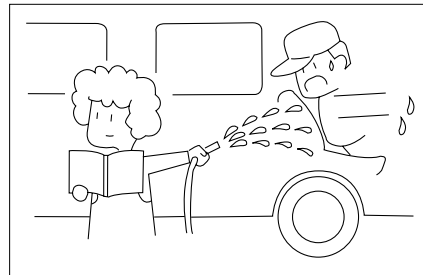

Care and Maintenance

1. We recommend that the tape below T-90. A class of tape are T-60, T-90, T-120.
2. If a loop of tape has formed, it must be taken up by turning one of the spools with a suitable object such as a ballpen.
3. Keep tapes in their plastic cases when not in use.
4. Never leave cassette inserted in operating position with tape player inoperative.
5. Don't apply oil to revolving parts of the tape player.

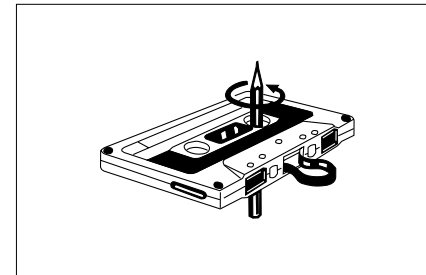

-
6. Store cassettes where they will not be exposed to high temperature, direct sunlight, magnetic fields, tape abrasion or dirt.
 7. Clean the head of tape player carefully with a cotton applicator soaked in alcohol. If the tape player is used for more than one hour every day, the head should be cleaned once or twice a month. If it is not used frequently, you only need to clean the head every two or three months.

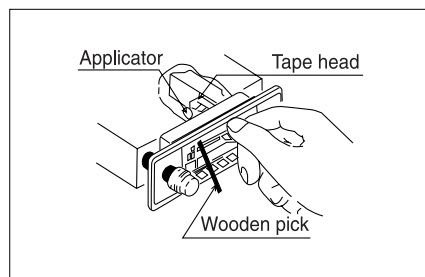

SPEEDOMETER

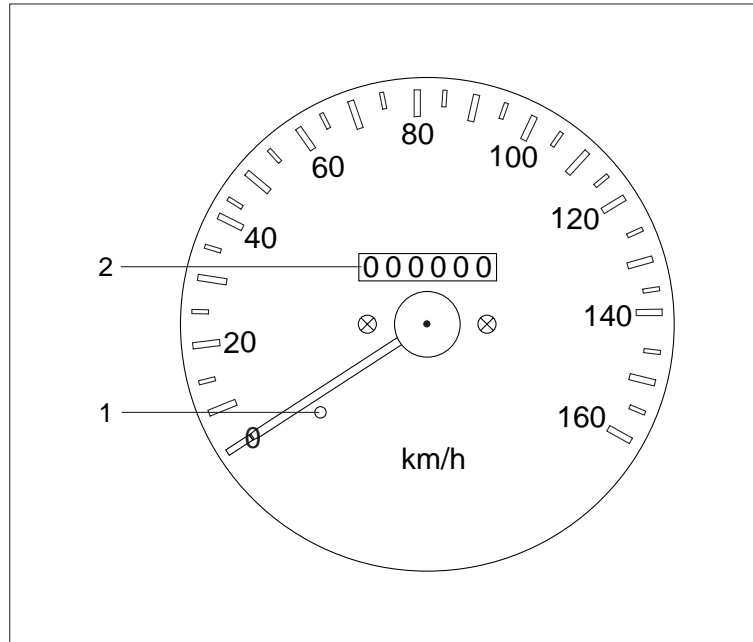

1. Speedometer needle
2. Odometer(distance)

- **Speed**

Recording and indicating ranges of 160km/h are available.

- **Distance**

Calibrateable odometer, 7-digit creeping, without ZERO settings.

TACHOGRAPH (OPTION)

Type A : Mechanical type–W/O RPM (SEPUNG), electric type–W/O RPM (SEPUNG, YAZAKI)

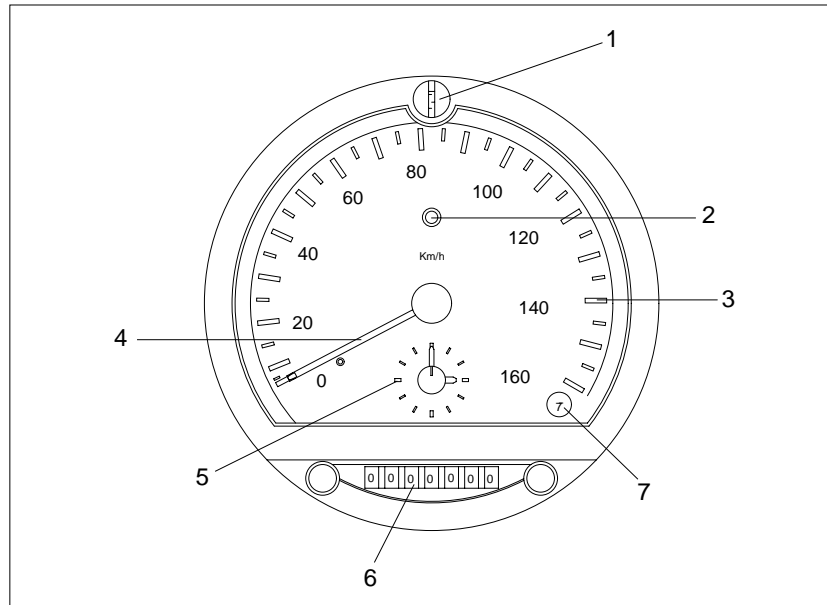

1. Key hole
2. Speed warning indicator light
3. Speed graduations
4. Speedometer needle
5. Clock check window
6. Odometer
7. Screen paper mark

Speed

Recording and indicating ranges of 160km/h are available, depending on model type.

Warning signal

Lights up when the speed between 40% and 60% of the maximum speed is reached.

- 100km/h (General)
- 120km/h (GCC members)

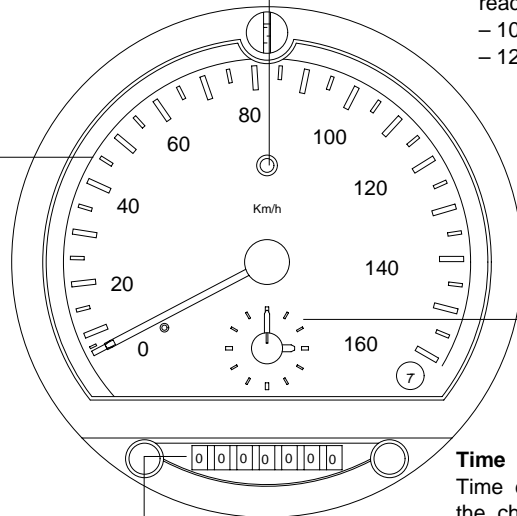

Time

Time display with time correct rotation of the chart, controlled by a high-quality quartz clock.

Distance

Calibrateable odometer without zero setting.

Illumination

The tachograph scale has indirect illumination by means of 1.2W bulbs or 24V depending on vehicle voltage.

Type B : electric type–W/RPM (VDO KIENZLE)

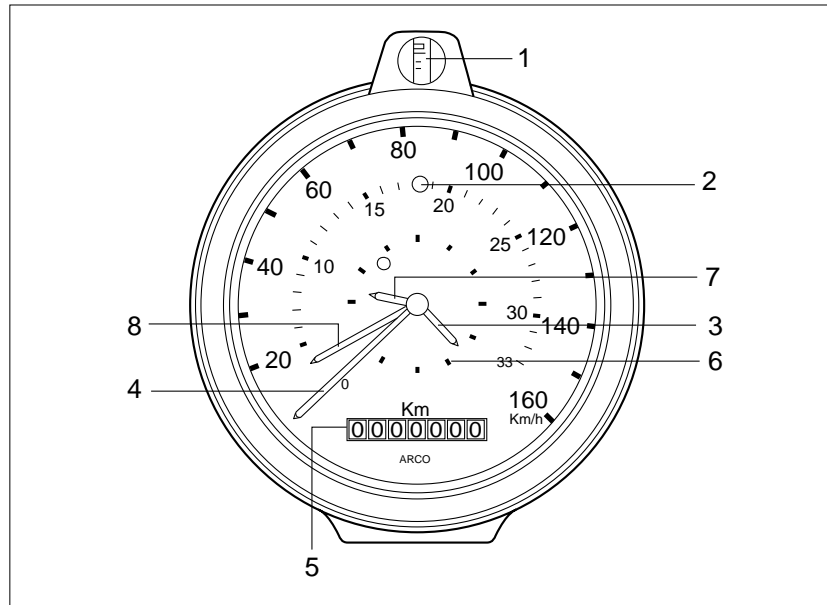

1. Key hole
2. Speed indicator light
3. Minute hand
4. Speedometer needle
5. Odometer
6. Clock graduations
7. Hour hand
8. RPM needle

Speed

Recording and indicating ranges of 160km/h are available, depending on model type.

Warning signal

Lights up when the speed is reached between 40% and 60% of the maximum speed.

- 100km/h (General)
- 120km/h (GCC members)

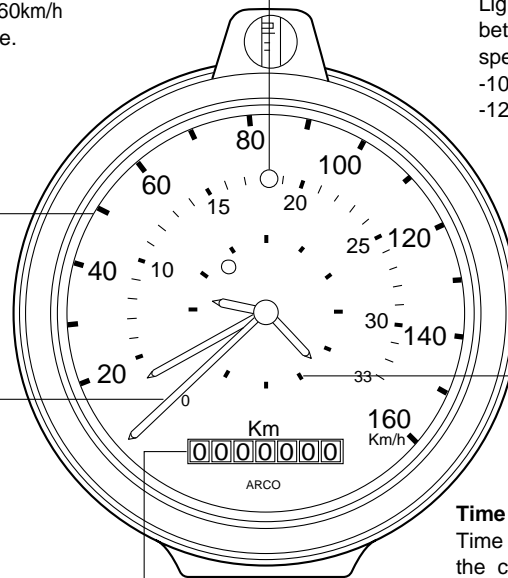

Engine speed

Additional feature to certain tachograph models – measuring range depending on model type.
160km/h / 3300rpm

Time

Time display with time correct rotation of the chart, controlled by a high-quality quartz clock.

Illumination

The tachograph scale has indirect illumination by means of 1.2W bulbs or 24V depending on vehicle voltage.

Distance

Calibrateable odometer without zero setting.

Type C : electric type–W/O RPM (VDO KIENZLE)

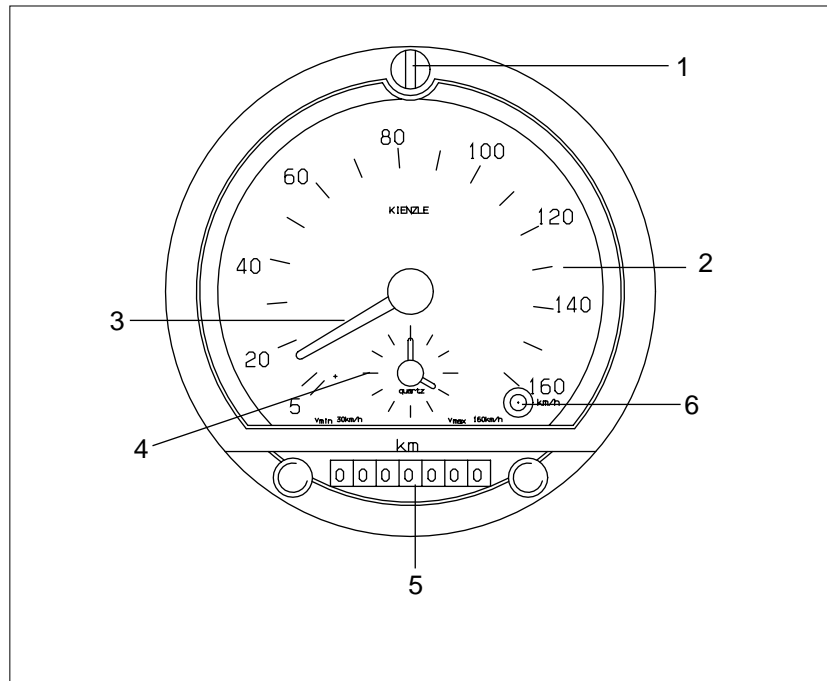

1. Key hole
2. Speed graduations
3. Speedometer needle
4. Clock check window
5. Odometer
6. Speed warning lamp

Speed

Recording and indicating ranges of 160km/h are available, depending on model type.

Warning signal

Lights up when the speed between 40% and 60% of the maximum speed is reached.

- 100km/h (General)
- 120km/h (GCC members)

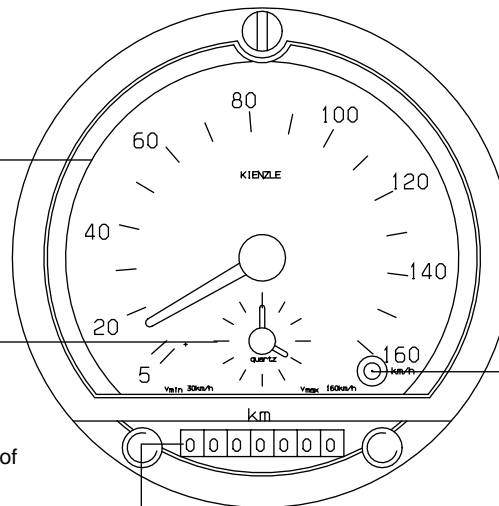

Time

Time display with time correct rotation of the chart, controlled by a high-quality quartz clock.

Illumination

The tachograph scale has indirect illumination by means of 1.2W bulbs or 24V depending on vehicle voltage.

Distance

Calibrateable odometer without zero setting.

HOW TO HANDLE TACHOGRAPH RECORDS

1. Remove the recording chart paper set by depressing and turning the retaining ring counter-clockwise. If the paper is handled roughly at the time of removal, the cutting knife will be distorted and become useless for further operation.
2. Filling out of recording chart paper
Before setting the recording chart paper in position, fill out necessary items on the recording chart paper, exercise carefully not to scratch the paper.
3. Setting of clock
Set the time by turning the time setting knob as necessary.
4. Setting of recording chart paper set
Position the recording chart paper set under the knife, then align the time on the paper with the red color mark near the knife.
Install the retaining ring by turning it clockwise while depressing it.

Further information by additional devices

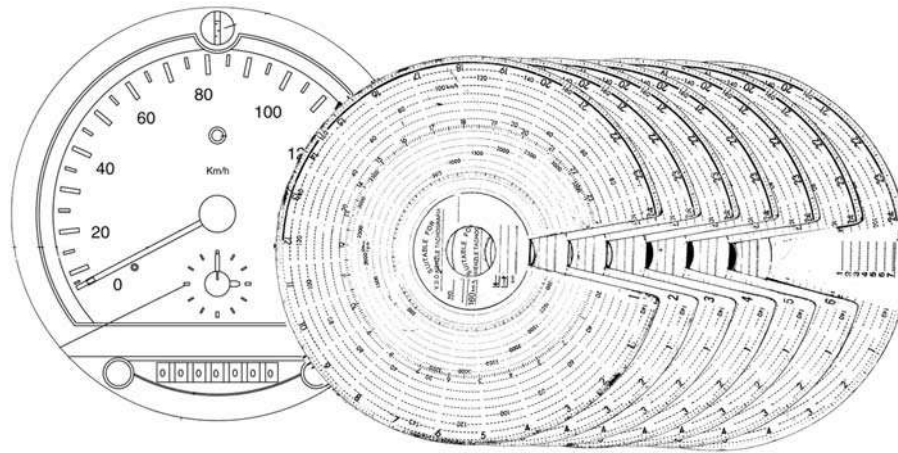

Basic information

- ① Start of driving
- ② End of driving
- ③ Road speed
- ④ Distance
- ⑤ Time scale
- ⑥ ENG Speed (OPTION)

Tachograph for 7-day recordings

A chart bundle is placed in to these special tachographs once a week. and for weekly, this is of particular advantage for vehicles which are being used regularly over extended periods. Automatically each day is recorded on a seperate chart ; these charts can be removed individually if required.

FLOOR CONTROLS

Gear shift lever (Except auto transmission)

When shifting the gear, fully depress the clutch pedal. Before shifting into reverse, be sure to stop the vehicle completely.

If reverse warning buzzer is equipped, the buzzer sound when shifted into reverse position.

The gear shift pattern is shown on the knob of shift lever.

(5.O.D/D.D)

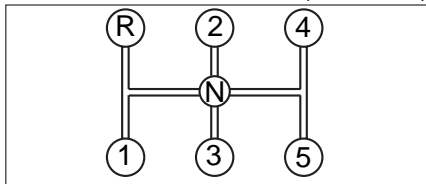

(6.O.D)

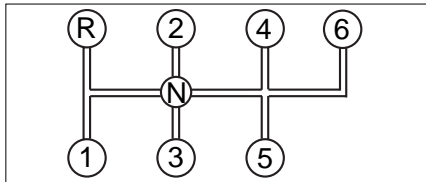

Accelerator pedal

To avoid unnecessary increase in fuel consumption, the accelerator pedal should be operated smoothly and reasonably.

Make sure that injection pump lever reaches maximum speed stopper when pressing accelerator pedal fully. If the lever won't reach the stopper, use accelerator pedal cable adjusting nut to adjust the cable length.

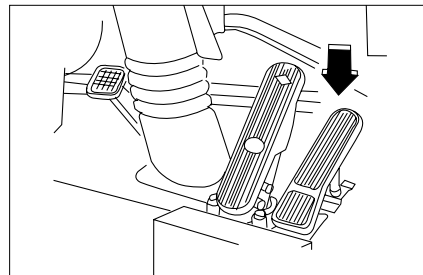

Brake pedal

When stopping your vehicle, do not press the pedal forcibly but try to press it repeatedly. On a downhill, use this pedal together with exhaust brake as required.

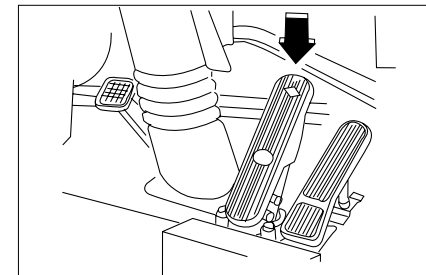

**Clutch pedal
(Except auto transmission)**

Fully push down the clutch pedal when changing gears. Do not rest your foot on the pedal when the clutch is not in use.

Premature wear of the clutch will result.

CAUTION

Service life of the clutch could be reduced when keeping it in a partially engaged condition.

**Parking brake lever
(For AOH brake)**

The parking brake is applied by pushing the knob backward.

To release, pull the knob slightly upward.

Be sure to set the parking brake lever firmly when parking the vehicle at unattended place.

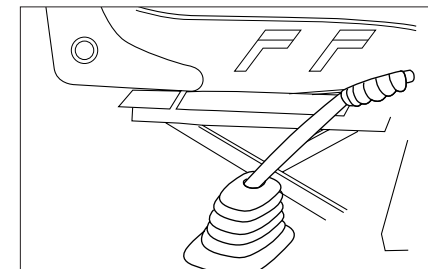
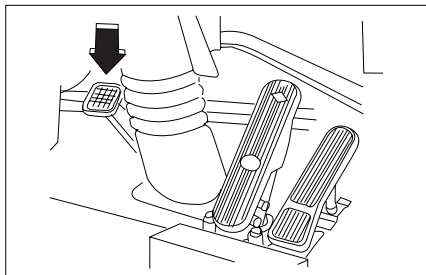

ENGINE STARTING IN ENGINE COMPARTMENT

- Engine can be started by the engine start control panel installed at the upper side of engine in the engine compartment.
- First switch "ON" the battery main switch in the driver's compartment, then set the toggle type start switch to "ON" to operate the starter switch, to stop the engine, push the stop button.

NOTICE

When the engine starter switch in steering column is located in "OFF" position, by setting the toggle switch to "ON", only the starter switch operates and the engine turns accordingly but the engine doesn't combust because the engine fuel cut lever is pulled. To run the engine, the engine starter key should be located in "ON" position.

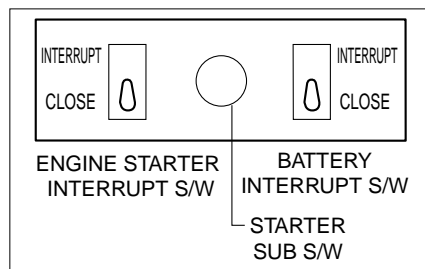

DRIVING

Proper care and operation not only extend the service life of your vehicle but also improve oil and fuel consumption.

Preparation for engine starting

1. Fix the vehicle with the parking brake lever.
2. Place transmission in neutral.
3. Put the engine stop handle off.
4. Press the battery main switch.

Check items inside of engine room installation of V-BELT

Loose belt can adversely affect the alternator charging system and cause engine overheating or premature wear to the belt.

On the other hand, a belt which is too tight can cause premature damage to the bearings of its peripheral devices. Frequently check and adjust belt tension. (Refer to page 113.)

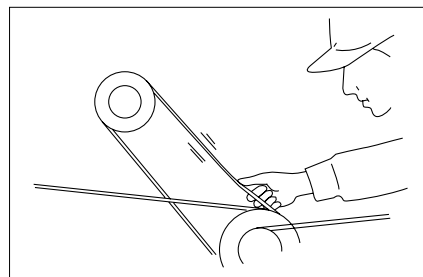

(No.1)

When installing a new belt, adjust the V-belt to be considered tension in the original position of tension device.

(No.2)

Check for fixing position of main engine pulley and compressor pulley.

(No.3)

Test operation for 2–3 minutes after adjusting the belt tension.

A sufficient tension is hung down 6mm from the belt center by vertically pulling-down of a spring balance.

(No.4)

It takes a few days to harmonize the belt to the pulley.

Adjust belt tension in accordance with No.3, when the belt became loose.

Keep the belt tension to moderate looseness so as not to slip off the belt from the pulley.

(No.5)

Check the belt tension two or three times per day for new belt, and check it once per day after a few days, after then, check it once in a month.

The belt slip-off might be caused by water or oil on the pulley.

Check belt tension as following :

(Push down the belt center with 8–11 kg load).

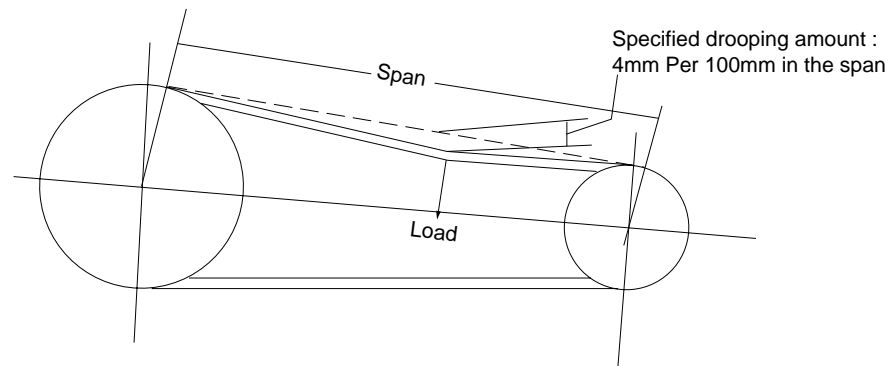

Engine oil level

- a. Pull out the oil level gauge(oil dipstick) to check if the oil tank has been filled up to the specified level.
- b. When the oil level is low, add the same brand oil according to "RECOMMENDED LUBRICANTS" and wait a while to check the level again. Also check for purity and viscosity of the oil before replenishing it.
- c. Always check the oil level with the vehicle parked on level ground and the engine stopped.

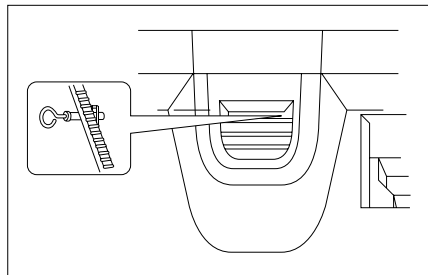

Power steering oil level

- a. Check the oil level and replenish as necessary.
- b. Check the pipe joints for oil leakage.

CAUTION

We strongly urge you to use Daewoo recommended power steering fluid for replenishment.

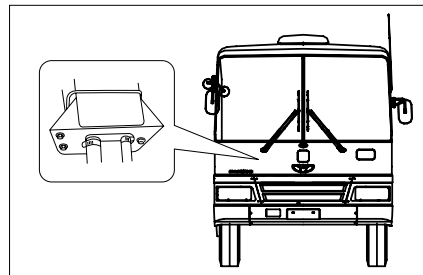

Engine coolant level

Check the level by the mark on the reservoir installed at upper side of radiator.

If the Engine coolant temperature lamp light comes on with sound in upper pilot lamp.

After opening the cap, replenish the coolant within 40mm from the end of filling neck.

Never open the cap when the engine is hot to avoid damages from the hot steam blowing out.

Operate the service when the engine is cooled sufficiently and on the level ground. Start engine and keep idling for 10~30 minutes after replenishment, then recheck the level and replenish if necessary.

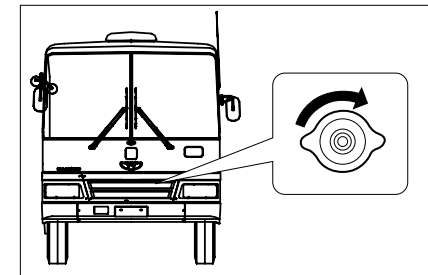

Air cleaner

Check the element contamination indicator, when the signal of indicator is yellow, the condition of element is normal, but red signal means that the element is fouled, then clean or change the element after inspection.

After service, push the button at the top of indicator, then the signal returns to yellow.

Extract out the dust by pressing both ends of dust trap with hand installed at the bottom of air cleaner body. Never remove dust trap or substitute with different materials.

In red, clean or change element. Push button to return yellow after service.

In red, clean or change element. Push button to return yellow after service.

76

Check items around driver's compartment

Clutch oil level

Check the clutch oil reservoir for oil level and contamination. If the level of clutch oil in the reservoir is too low, replenish up to the MAX mark.

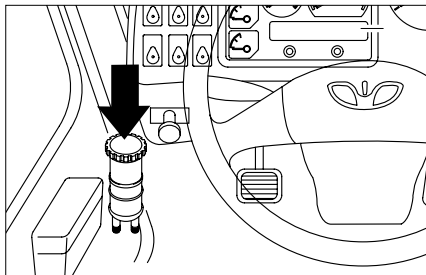

Windshield washer fluid level

Check fluid level in the reservoir and replenish as necessary.

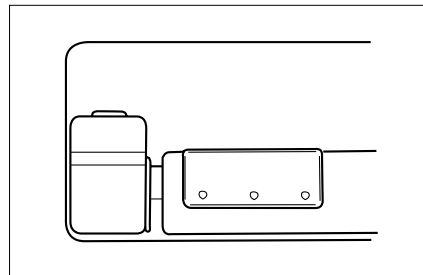

Check items exterior and under chassis

Battery(MF) (OPTION)

- a. This MF battery needs no periodic maintenance as long as it is used properly.
- b. Check the charge state through the indicator installed on the face of the battery.

Test indicator	Charge State	Correction
Green	Normal	Use
Black	Low charge level	Recharge
Transparent	Low electrolyte level	Replace

- C. If the external part of the battery is found foul, clean it with tepid water.
Apply a thin coat of vaseline or grease to the battery terminals to prevent corrosion.

Battery (PT/PTC)

- a. This PT/PTC battery for intense cold needs periodic maintenance every 5,000km on driving
- b. Must check the electrolyte in not enough propriety and slip of battery terminal
- c. If the external part of the battery is found foul, clean it with tepid water and apply a grease to the battery terminal to prevent corrosion.

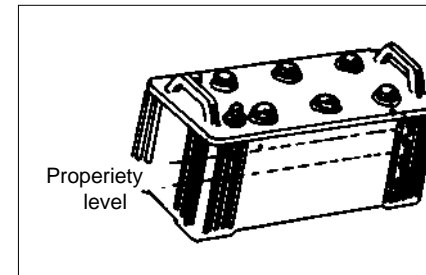
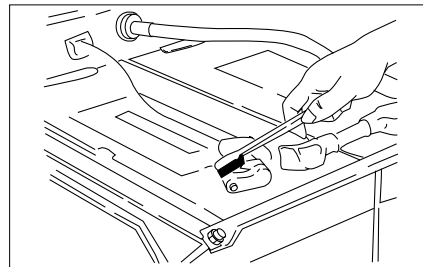
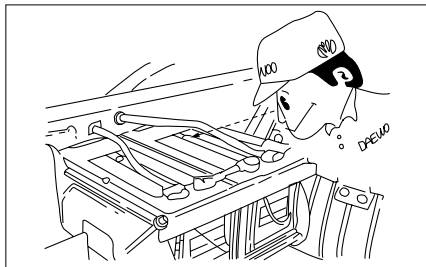

d. Level of battery electrolyte must kept up between 'upper level' and 'lower level'

When battery electrolyte in below the 'lower' position, Replenish the distieled water until state is 'upper' position

(Only a position level on Battery is indicated 'Lower' position)

e. If the level not indicated on battery, electrolyte must kept up with-in 10mm of a upper pole plate and when it below the propriety level, Replenish the distilled water

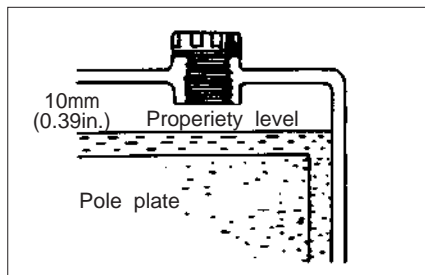

f. In water, the state of battery electrolyte must kept up replenish perfectly so to provnt dangerous of freezing

NOTICE

When exchange the battery, give special attention to connect cables correctly.

If cables are misconnected, all the electric equipments will be damaged.

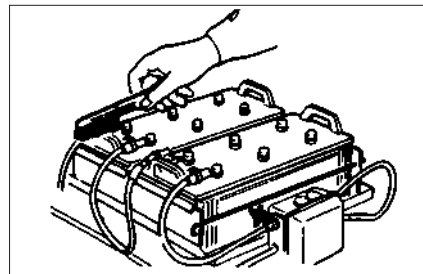

WARNING

Unexpected and possible battery discharge may occur, if the following precautions are not taken.

- *While the engine is not running.*
 - *It may give rise to battery discharge, if leave the vehicle switched 'ON' of battery for long time or operate too many electric equipments at a same time.*
 - *For long time parking, front entrance door must be closed by it's key and for the long time suspension of operation, it would be better disconnect the battery cable.*
- *While the engine is running.*
 - *While air conditioner is working, it is advisable to raise the engine RPM.*

Specific gravity of electrolyte

* Basic electrolyte temperature=20°C (68°F)

Condition \ Zones	Temperate	Tropics	Frigid
Full-charge	1.26 or more	1.22 or more	1.28 or more
Half-charge	1.25 – 1.14	1.21 – 1.10	1.27 – 1.16
Discharge	1.13 or less	1.09 or less	1.15 or less

Note : 1. When temperature of electrolyte deviates from 20°C(68°F) at hydrometer check, temperature correction should be made by the following formula.

$$S_{20} = S_t + 0.0007 \times (t - 20)$$

* S_{20} Corrected specific gravity (20°C)

S_t Hydrometer reading at $t^\circ\text{C}$

t Temperature of electrolyte when checked

2. When lowering of electrolyte level is due to spillage, replenish with dilute sulfuric acid of the same specific gravity.
3. When replacing the battery, exercise extreme care so as not to make uncorrect connections, or damage to alternator silicon diodes will result.

Tire

- Check inflation pressure of the tires with a tire air gauge and add compressed air if necessary.
- Improper inflation pressure affects adversely tire service life, reduces motoring comfort, and, in the worst case, may cause tires to be overheated and consequently exploded.
- Check also the wheel pin nuts on the wheel for looseness.

CAUTION

Tighten to specified torque (60~65kg·m) as excessive tightening torque may cause damage to the wheel pin.

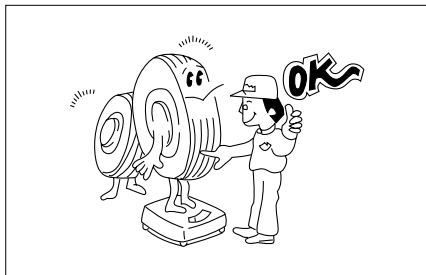

Tire size	Normal inflation pressure in kg/cm ² (PSI)
10.00-20-16PR (Tube)	Front : 8.1kg/cm ² (115PSI)
10.00R-20-16PR (Tube, radial)	Rear : 7.4kg/cm ² (105PSI)
11.00-20-16PR (Tube)	Front : 8.4kg/cm ² (119PSI)
11.00R-20-16PR (Tube, radial)	Rear : 7.7kg/cm ² (109PSI)

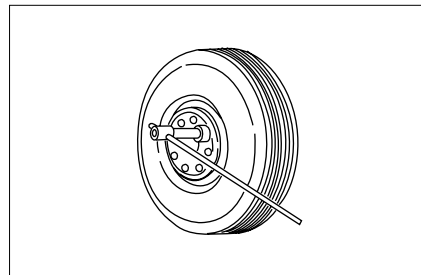

Draining of air tank

From time to time, pull forward the drain cock installed underneath the air tank to drain off condensates produced in it.

- When opening the drain cock, pull it forward as shown.

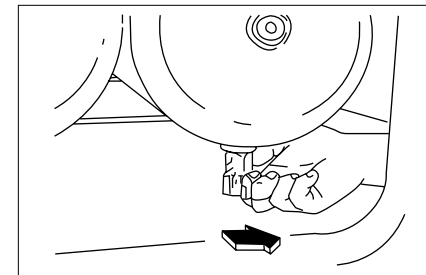

Chassis spring

Check chassis springs for damage and tightening condition of 'U' bolt.

If any damaged or separated spring leaf from normal position is found, stop the vehicle operation and have service.

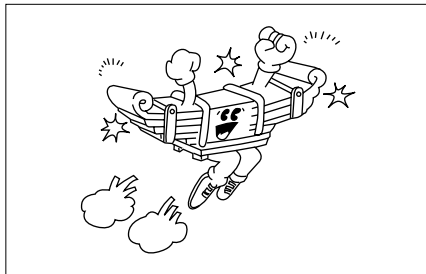

STARTING AND STOPPING THE ENGINE

Preparation for starting the engine

1. Apply the parking brake firmly and shift the gear lever to NEUTRAL position.
2. Push on the battery main switch.
3. Turn the starter key to "ON".

Starting the engine

1. Turn the starter key to START position. Avoid excessive starter cranking(in excess of 10 seconds) to prevent any possible damage to starter motor or batteries. If the engine fails to start, wait about 30 seconds before attempting to start engine again.
2. Use the idle control knob to idle the engine at the normal speed (rpm) until the normal operating temperature is reached.
3. Do not overrun the engine under the normal operating temperature not obtained. This may shorten the engine life and increase fuel consumption.

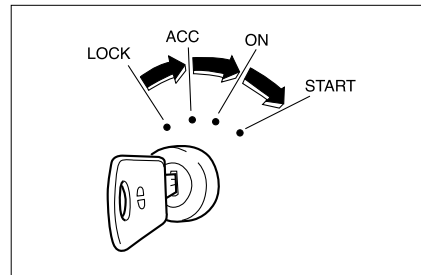
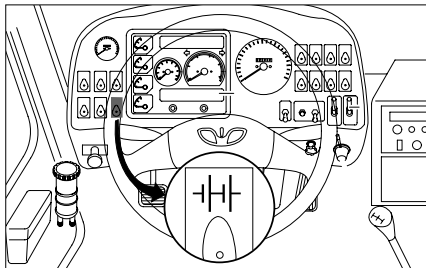

4. Take exceptional care to adjust idle speed when the engine temperature is low.
5. If you had attempted to start engine with no fuel in the fuel tank, you should bleed the fuel system. With no bleeding operation, you cannot start the engine even after refilling the fuel tank.(Refer to "Bleeding of fuel system" on page 107.)

Starting the engine in cold weather

1. With the switch in the "ON" position the indicator lamp will light up showing the engine is pre-heated automatically. After pre-heating is completed, the indicator lamp will go out.
2. After pre-heating is completed, press the clutch pedal and accelerator pedal to start the engine.
3. Use the idle control knob to idle the engine at a moderately fast speed. Normal idle speed : 550~600 rpm.

4. Avoid unnecessary idling of the engine when coolant temperature reaches above 60°C.
5. After warming up the engine, bring the idle control knob back to its original position.

CAUTION

Abrupt start during warming-up operation may shorten the engine life.

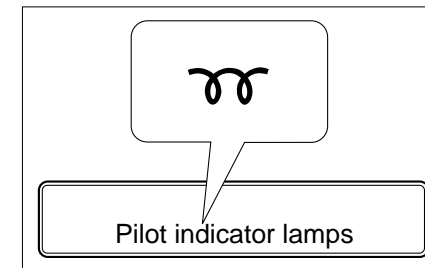
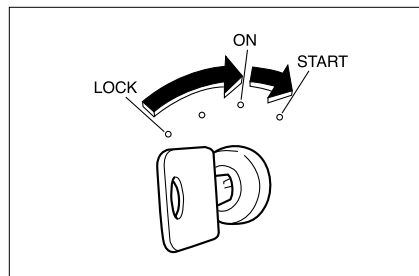
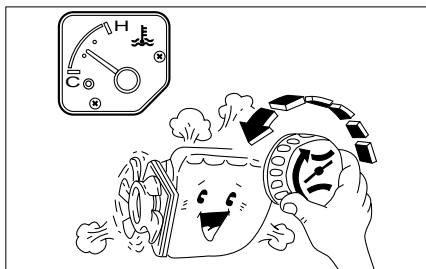

Stopping the engine

Turn the starter key switch off and turn and push the battery main switch off.

Sudden stopping of the engine after severe operations like full load or ascending a slope causes overflow of coolant. In this case, idle the engine for 5 or 10 minutes before stopping it.

Diesel engine is apt to keep running even after the battery main switch is off, while the engine is in running, do not push off the battery main switch, otherwise, alternator circuit may be failed.

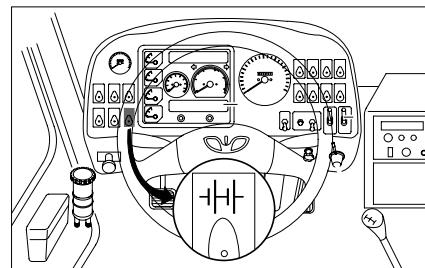
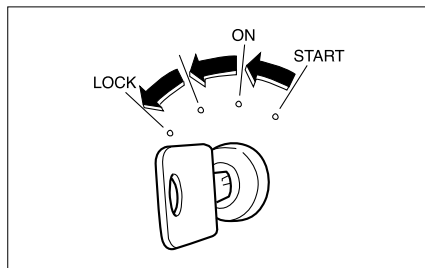

BEFORE DRIVING OFF

Steering wheel free play

Check the amount of the steering wheel free play by gently turning the wheel in both directions. The free play should be within the range of 30 ~50mm at the periphery of the wheel when checked with the front wheels positioned straight ahead.

CAUTION

Check steering wheel for free play with the engine running.

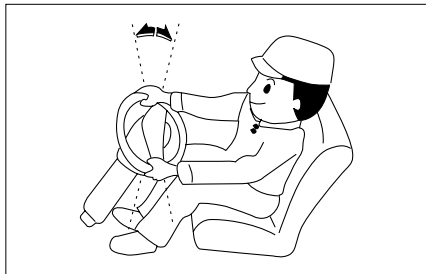

Air parking brake switch (For full air brake)

In air parking brake switch applied vehicle, be sure to release parking brake before driving, also check the park warning lamp goes out before driving.

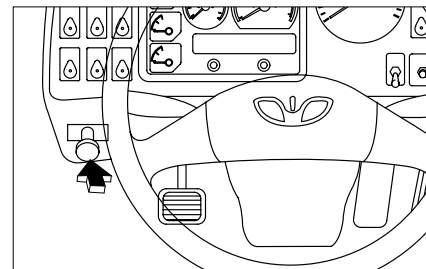

Parking brake lever (For AOH brake)

Before travel, manipulate the parking brake lever to check for its motion. Pull downward the lever to start running. Check the park warning lamp goes out before driving.

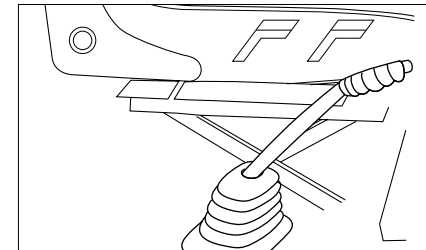

PARKING

Pilot indicator lamps

Windshield wipers

Check the operation of windshield wipers and washer fluid ejection, keep the front windshield glass clean all the time.

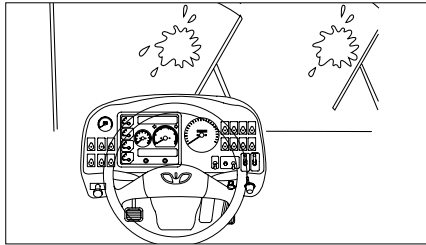

Instrument panel, indicators and gages

Check the instrument panel, indicators and gages operate in normal conditions when the related switches are actuated.

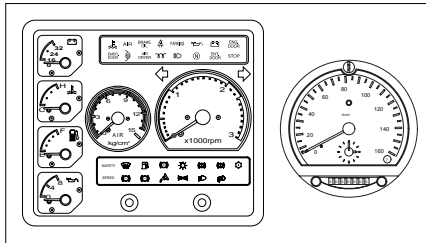

Clutch pedal (Except auto T/M)

Check the clutch pedal free play, if the free play deviates from 40~50mm, adjustment is necessary.

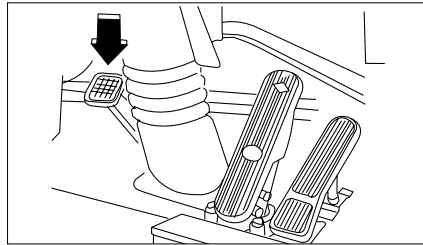

Brake pedal

Check the brake pedal free play, if the free play deviates from about 15mm, adjust the screw fitted at the bottom end of pedal.

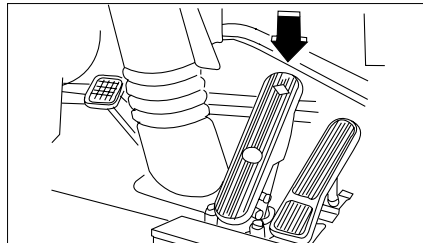

Door

Check the operation of door(open, close), be sure that the doors are closed before driving.

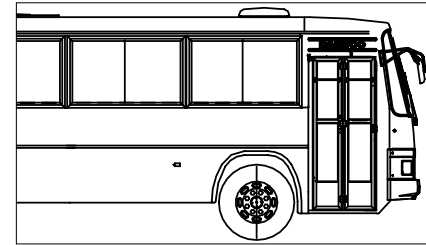

Mirror

Adjust side mirrors to have wider visions, also check room mirror before driving.

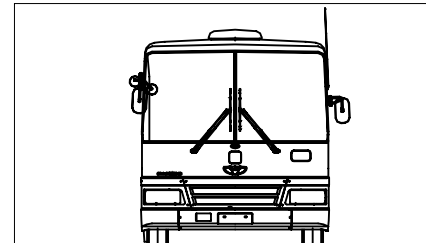

WHEN DRIVING OFF

- Check if the needle of air pressure gauge indicates 4.8kg/cm² or above. If the gauge indicates below this range of air pressure, keep the engine running at fast idle until the gauge needle points to the rated pressure.
- Check again that any abnormal warning lamps or unnecessary lights are come on and recheck the “park” indicating lamp gone out surely.
- Let the engine idle until it is fully warmed up and coolant temperature increases beyond 60°C before starting off, and start the vehicle with the shift lever in 1st position.

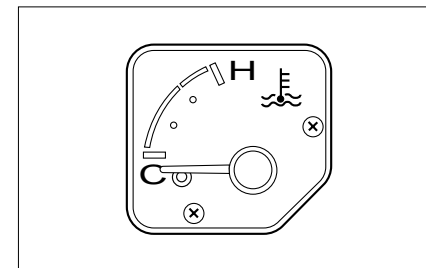
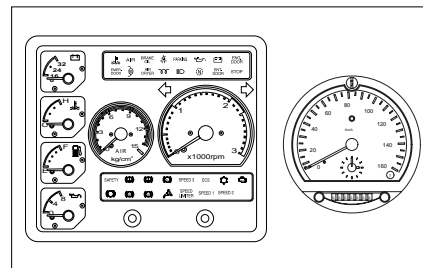
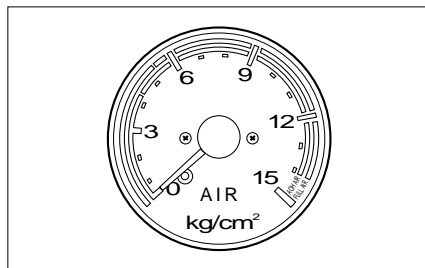

WHILE TRAVELING

- Avoid overrunning the engine during break-in period of new vehicle.
- If indicator lamps or instruments give an indication of abnormal condition while driving, stop the vehicle and check to locate the cause of trouble.
 - ★ If the cause of trouble was not located, check at your nearest Daewoo dealer.
- If unusual sound or smell becomes noticeable while driving, stop the engine and check to locate the cause of trouble.
- If the air pressure falls below 5.3kg/cm², stop the engine and check to locate the cause of trouble.

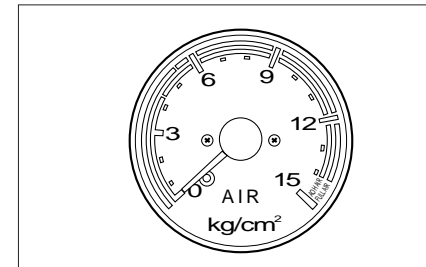
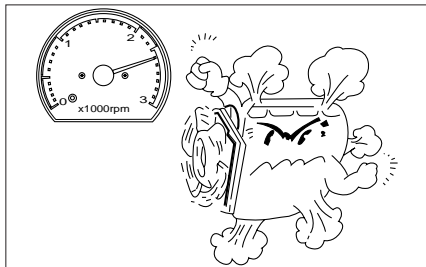

- The engine coolant temperature gauge needle should indicate below the red point. If the gauge indicates above red point, stop the vehicle and keep the engine running at idle, and check the engine coolant level.

★ Severe burns to the skin can result from removing the pressure cap from a hot radiator. Wait until the engine temperature goes down and use rags to remove the cap for check-up and refilling operations.

- Avoid engine racing, unnecessary sudden acceleration, or sudden stops.
- Do not drive with your foot resting on the clutch pedal as it produces a partially disengaged condition, causing premature wear of clutch facing.

- Stop your vehicle completely when attempting to shift gear lever into reverse.

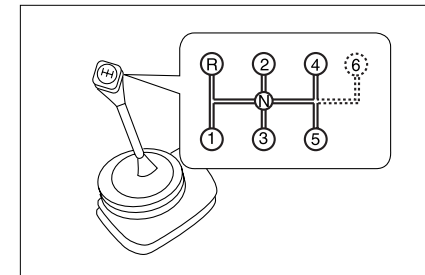
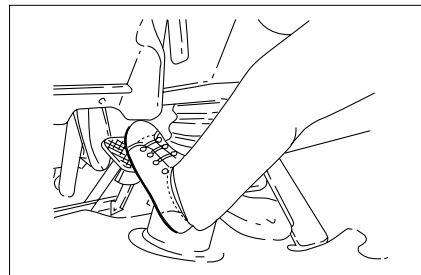
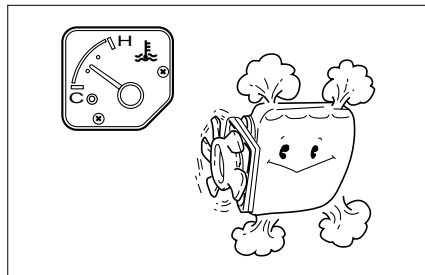

- When ascending a slope, shift to lower gear to relieve the engine from overload.

- When descending a slope, shift to lower gear to gain retardation effect of the engine. It is advisable to use the exhaust brake and engine brake in combination when descending a slope. Frequent use of foot brakes while descending a long slope will cause brake drum overheating and consequential malfunction of the brake.

- Special care should be taken when descending a slope, particularly when shifting down into lower gear, as the engine is liable to overrun. Excess engine rpm may result in trouble with each part of the engine, especially possible breakage of valve spring and push rod.

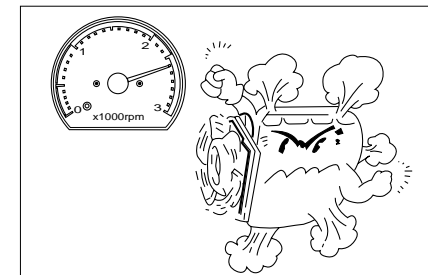
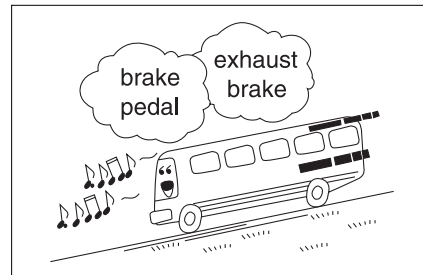
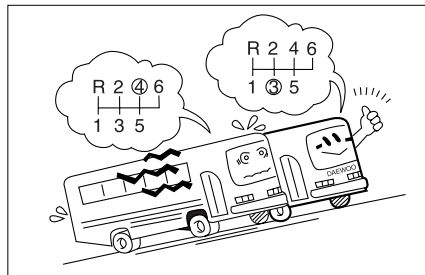

AFTER DRIVING

Engine stop

If there is an indication of engine overheating, never stop the engine immediately, keep running at idle for a while, after the temperature drops to the normal range, stop the engine. Also, turn and push the battery switch off before parking.

Diesel engine is apt to keep running even after the battery relay switch off, while the engine continues running, never push the battery switch off, after check that engine stops running, turn and push the battery switch off. Otherwise, the alternator circuit may be failed.

Parking

Place the gear shift lever in neutral position and set the parking brake lever securely.

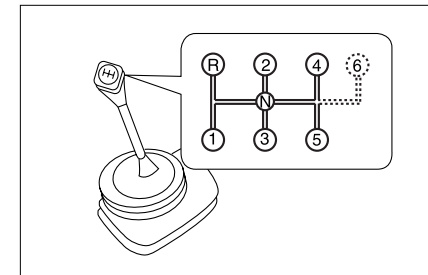
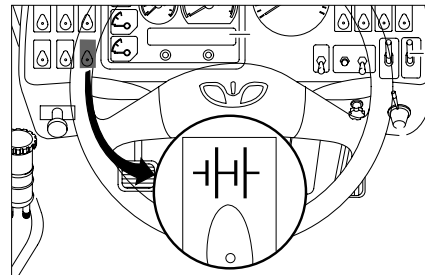
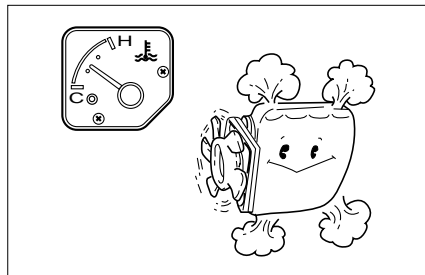

Service and repair after operation

After operating the vehicle, always clean it thoroughly and check the following points :

1. Re-check the troubles found during the previous operation and take necessary corrective actions. For such troubles difficult to correct, contact your nearest Daewoo dealer.
2. Check for leakage and oil levels.
3. Add antifreeze to engine coolant to prevent freezing of the engine in cold weather.

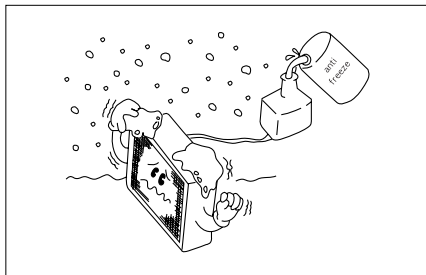

DRIVING ON HIGHWAY

The followings should be performed for safe and dependable vehicle operation.

Before driving

More special care should be taken to drive on highway than urban road. Make sufficient inspection according to "DAILY CHECK BEFORE DRIVING".

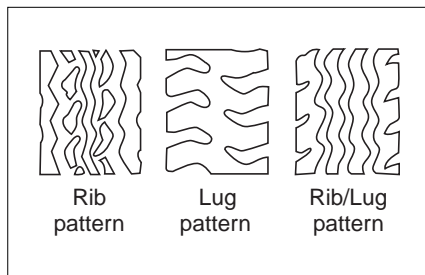

Tire

Heat generation depends on vehicle speeds and load weights. For the vehicle which travels frequently on highway, rib pattern tires are preferable.

Frequently watch speedometer readings in instrument panel.

CAUTION

It is dangerous to drive your vehicle with tires whose treads have been worn out excessively, because the vehicle may lose traction.

Limit of use: The depth of the tread grooves should be more than 3.2mm.

Driving on highway

Driving on highway is more dangerous than the urban road, you should be more alert and have a stable preparations.

1. Speed perception

On highway, driver's speed perception is liable to become dull because its road surface is even and commands a wider prospect than urban road.

Frequently watch speedometer readings in instrument panel.

NOTE

You must fully understand vehicle performance in driving on highway.

1. Acceleration

As running resistance increases greatly while driving on highway, the vehicle should be accelerated with allowance for its engine power.

2. Gradeability

Maintain suitable engine rpm taking into account the relation of grade and maximum speed at each gearshift position.

3. Fuel consumption

2. Braking distance

Braking efficiency is the most important thing when driving on highway. When recognizing the hazard ahead and preparing to apply the brake, your reaction time will take about one second. This means that your vehicle, if assumed to have run at speed of 80km/h, will travel additional 20 to 30m the moment you applied the brake. Therefore, you should maintain a safe following distance.

3. Distance between vehicles

Normally, the following distance between your vehicle and the vehicle ahead depends on vehicle speeds. A safe following distance of about 80m should be maintained in 80km/h traffic.

4. Passing

To pass, increase your vehicle's speed by at least 10km/h more than the speed of the vehicle ahead. Before preparing to pass,

be sure to check the traffic behind you and then pull out into the left lane(in case of RHD, the right lane) promptly with turn signal "ON".

5. Turning on a curve

Generally curves of highway are given grade on their either side. With a light movement of the steering wheel the vehicle turns very easily. Therefore, be careful of tire slippage when applying the brake on a curve, especially in rainy weather or on an icy road.

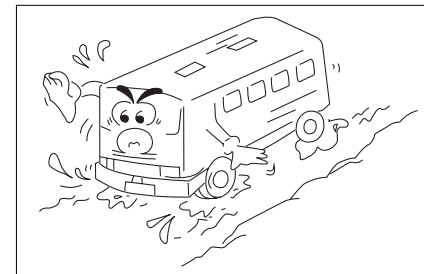

6. Others

- To enhance braking efficiency, use the exhaust and engine brakes in combination.
- Reckless steering may cause danger not only to your own vehicle but also oncoming vehicles.
- In the event that a tire was punctured during driving, hold the steering wheel firmly and employ exhaust brake to slow down. Abrupt braking can cause damage to tires.

OPERATION AND CARE IN COLD WEATHER

Protection of the engine against freezing

Overcooled engine not only accelerates wear of its vital parts but also reduces fuel economy. Before driving off, warm up the engine beyond 60°C.

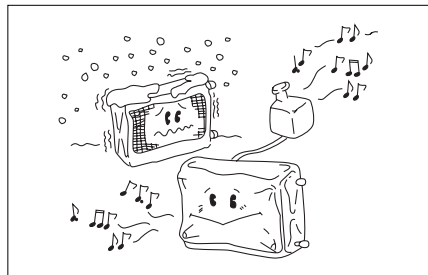

Use of antifreeze

To prevent freezing and corrosion of the engine when operating the vehicle in extremely cold places, be sure to add a specified amount of antifreeze to coolant.

AREA	Mixing ratio(%)	Freezing point(°C)
RUSSIA(Frigid)	55(%)	-48(°C)
SOUTHEAST ASIA MIDDLE EAST AFRICA SOUTH AMERICA	30(%)	-12(°C)
TAIWAN	50(%)	-38(°C)
OTHERS	30(%)~40(%)	-16(°C)~-25(°C)

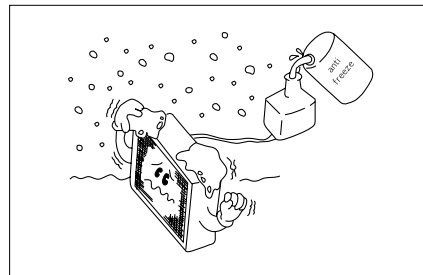

Precautions when using antifreeze

1. Wash off the inside of the cooling system including the radiator before using anti-freeze.
2. Replace any damaged rubber hoses. If there is just a hair crack on these hoses, antifreeze is liable to leak.
3. Antifreeze should be handled with extreme care as it can cause damage to coated surfaces of peripheral components.

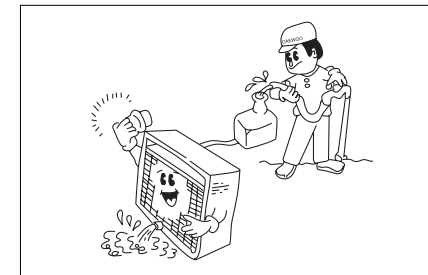

Engine oil

Engine oil tends to harden when the ambient temperature falls in cold weather. Use the specified engine oil having proper viscosity.

Batteries

Battery condition tends to get worse with drop in ambient temperature. In extremely cold weather, maintain the battery in a full charge state.

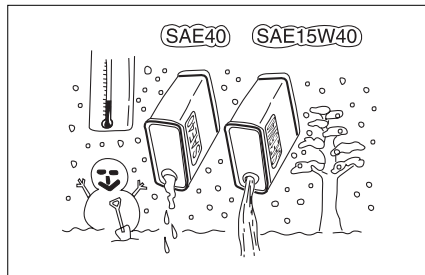

Driving on ice or snow

It is advisable that chains or snow tires be used when traveling on an icy or snowcovered road. If you apply the brake hard on a slippery road, your vehicle is apt to lose its traction, resulting in losing the control of steering wheel.

CAUTION

Carefully fit chains on your tires so that the chain band may not scratch the other parts or interrupt their movements.

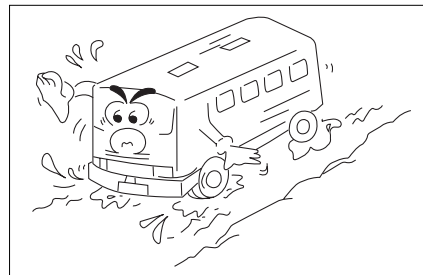

1. Be sure to use the chain of the same dimensions as the target tire.
2. Fit the chains on the rear tires and tighten them so that motions of the other parts may not be interrupted.

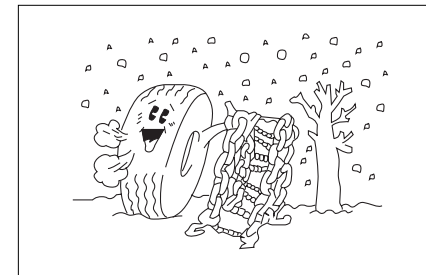

IN CASE OF EMERGENCY

Emergency stopping

- In case of vehicle trouble or emergency stopping, pull up the vehicle to the roadside as early as possible.
- Set the parking brake and turn on the emergency warning lamp to prevent possible safety hazard.

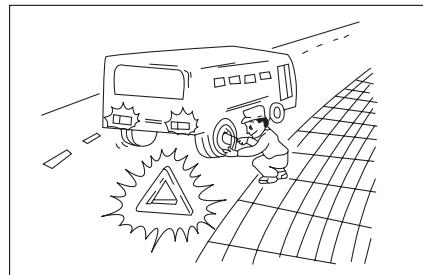
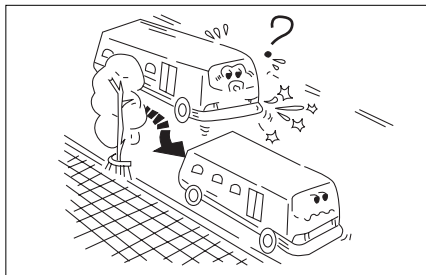

Emergency starting

- Avoid starting the engine while your vehicle is being towed as it may collide with the towing vehicle.

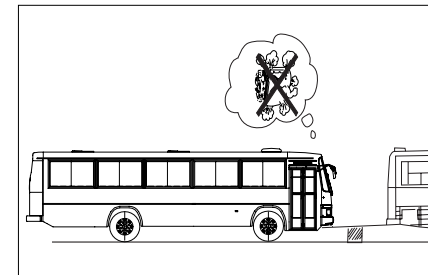

Battery jumping

In the case that the battery has been “dead”, refer to “BATTERY CARE” in this manual and make an emergency start as illustrated.

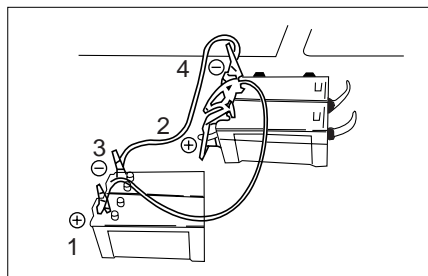

INSPECTION AND MAINTENANCE

DAILY CHECK BEFORE DRIVING

In order to maintain safety and dependable operation, following checks should be performed daily before driving :

System	Check item	Check point
Steering	• Steering wheel and system	1. Vibrations or shimmy of steering wheel 2. Hard steering or sticky 3. Damage or looseness of component parts
Brake	• Brake pedal • Brake and clutch oil • Exhaust brake • Parking brake • Air tank and pressure	1. Air mixed in brake circuit 2. Free play, stroke and force pedal • Oil level • Function • Function • Moisture in tank and fluctuation of air pressure
Running	• Wheels and tires	1. Damage or looseness of bolts and nuts. 2. Damage or severe wear of wheels and tires, and tire inflation pressure.
Suspension	• Chassis spring	• Damage of spring, and tightening state of U-bolts and nuts.
Engine	• Engine	1. Engine starting 2. Abnormal sound and vibration 3. Leakage of fuel, lubricants and coolants 4. Cleanliness and damage of air cleaner element 5. Exhaust gas 6. Damage of fan belt 7. Engine oil level
Power train	• Clutch • Transmission • Propeller shaft and rear axle	• Clutch pedal free play, stroke and function • Function and oil leakage • Vibration of propeller shaft, oil leakage in rear axle

PERIODIC INSPECTION AND MAINTENANCE

Engine oil

Oil level check

Check oil level and replenish if required. Pull out the oil level gauge rod(dipstick) at the bottom side of the engine and wipe it clean, insert the gauge fully into guide tube and remove it carefully, then check the level of oil between the high and low level marks. Also check the oil sampled with the gauge rod for deterioration.

After checking oil level, insert the level gauge into guide tube properly and tighten the oil filler cap firmly.

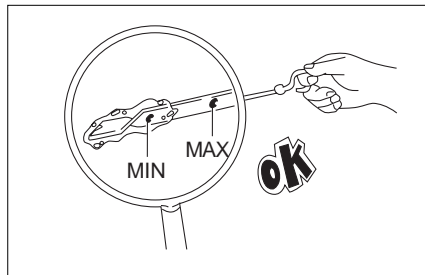

NOTE

Engine oil level should be checked with the vehicle parked on a level ground and with the engine stationary. If the engine has been operated, allow 20 minutes for oil to settle down before checking the oil level.

Type of oil

- Frigid an area :
API CF-4 or SAE 15W/30
- Except Frigid an area :
API CF-4 or SAE 15W/40
- Refer to "Lubrication list" at page 155.

Changing engine oil

Change engine oil at specified intervals or when found to be fouled considerably. To drain, remove the drain plug from oil pan, when changing oil warm up the engine sufficiently to remove moisture contained in oil. Thoroughly remove metal chips stuck to drain plug.

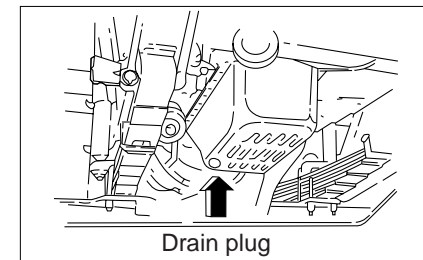

Model	Change intervals	Capacity
D1146	<ul style="list-style-type: none"> • Initial : 1,000km • Inter-city or long distance travel bus every : 15,000km 	ENG.TOT 15.5 l
		Oil pan 13 l
DE12	<ul style="list-style-type: none"> • City bus every : 10,000km 	ENG.TOT 20 l
		Oil pan 17 l
DE08TIS	<ul style="list-style-type: none"> • Initial : 1,000km • Long distance : every 30,000km • Short distance : every 20,000km 	ENG.TOT 19 l
		Oil pan 15.5 l

Engine oil filter

Engine oil filter element should be changed together with engine oil at the same time.(DE engine is mounted with a cartridge type)

1. To drain oil, remove the drain plug installed on the lower part of oil filter body. Remove metal chips stuck to drain plug, Check gasket and replace as necessary.
2. Loosen the center bolt and remove the filter body together with the element.
3. Clean the inside of filter body and replace with new filter element.
 - ※Clean the element with diesel fuel and visually check gaskets installed on the upper and lower sides of element for damage and hardening, and replace as necessary.

CAUTION

It is strongly advisable to use genuine Daewoo oil filter element.

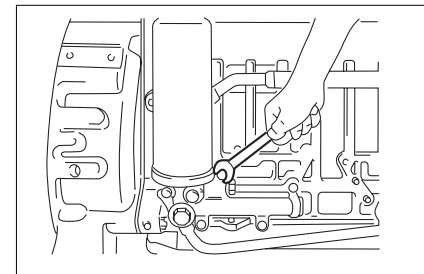

Engine coolant

Coolant level

Check the level of coolant by the reservoir installed at upper side of radiator. Use clean rain water or city water for the cooling system and avoid the use of hard water such as drawn out of a well. Never open the pressure cap while the engine is hot or hot steam may blow out causing serious injuries.

NOTE

In order to avoid the accumulate of scale, corrosion for the entire cooling system and damage from cavitation, coolant mixed with 30% of antifreeze solution should be used all year around.

Some regions where antifreeze solution is not easy to purchase, cavitation protection solution "Inhibitor" could be used, nevertheless antifreeze solution is the best way to have maximum service life.

Change of coolants

Drain the coolant by opening the drain cock of radiator. After completely draining off, close the drain cock and fill with new coolant. Run the engine for about 10 minutes and then recheck the coolant level.

In the case that antifreeze is added to coolant, it is advisable to clean the inside of the radiator and engine water jacket 2 times a year (in spring and autumn).

- refer to 'Lubrication list' at page 155.

Model	Coolant volume
BF106	33(37)

* (): Preheater included

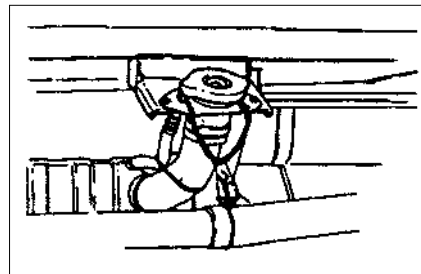
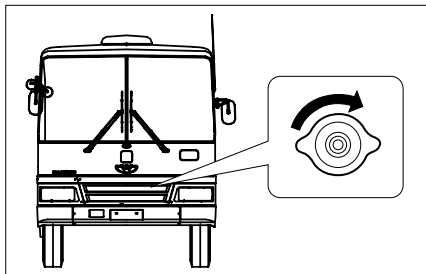

Fuel filter (D1146 ENG.)

The fuel filter system is of the two stage type with a felt element as a primary filter and a paper element as a secondary filter.

Fuel is transported from the outside of the filter to its inside. At this time, impurities contained in the fuel are caught outside the filter.

Replacement

Replace secondary element at the same time when the engine oil is changed. Clean primary filter at every 5,000km and replace with new one after the lapse of 3 cleaning intervals. Restricted fuel filter will hinder in smooth transportation of fuel, resulting in decrease in engine power.

Cleaning (Primary element)

Soak the felt element in diesel fuel and remove heavy dust particles by using a brush with soft bristles. If the element is found defective, replace it with a new one.

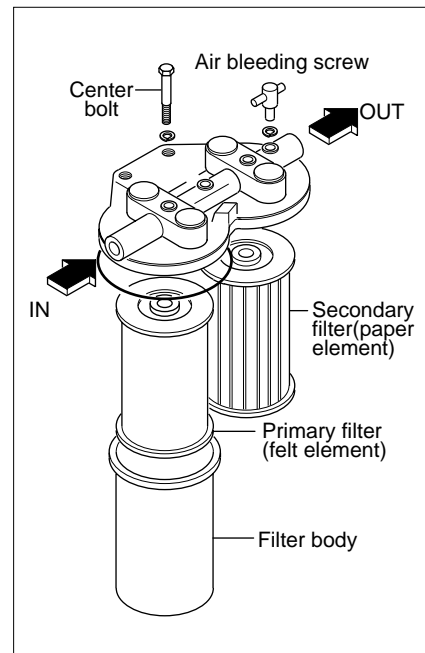

Disassembly and cleaning

1. Unloosen center bolt, and remove filter body.
2. Take out felt element and paper element.
3. Clean filter body and felt element.
4. Change paper element.
5. When reassembling reverse the above sequence.

CAUTION

It is strongly advisable to use genuine Daewoo fuel filter element.

NOTE

Sometimes (at 10,000km) drain the filter pump of water until clear fuel is visible.

Fuel filter (DE12, DE08TiS ENGINE)

The fuel filter system is single cartridge type with a paper element as a primary filter.

Fuel is transported from the outside of the filter to its inside. At this time, impurities contained in the fuel are caught outside the filter.

Replace the cartridge

At every 20,000km.

Restricted fuel filter will hinder in smooth transportation of fuel, resulting in decrease in engine power.

Method of replacing

1. Unloosen drain plug
2. Remove old cartridge.
3. Clean head sealing surface
4. Fill the fuel in new cartridge.
5. Lubricate the rubber packing, surface
6. Spin cartridge until packing contacts head.
7. Then tighten additional 3/4 to 1 turn.

NOTE

Sometimes (at 10,000km) drain water.

CAUTION

It is strongly advisable to use genuine Daewoo fuel filter cartridge.

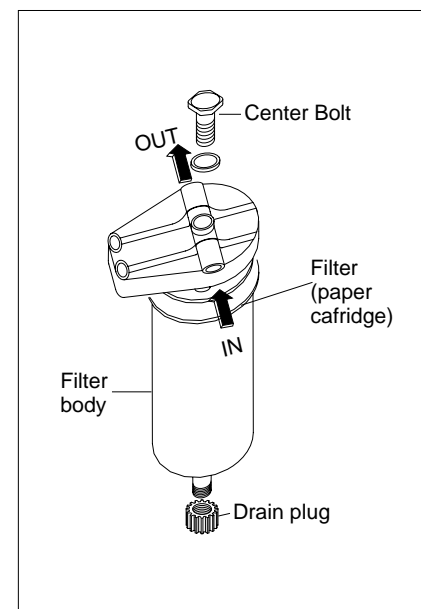

Bleeding of fuel system

Bleeding of fuel system must be performed when fuel filter has been removed or the engine has been stopped due to lack of fuel.

(DE12, DE08TiS ENG.)

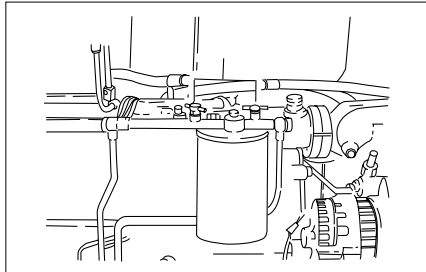

(D1146 ENG.)

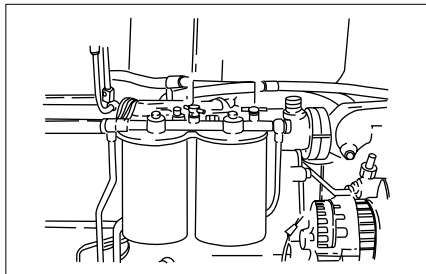

1. Turn the cap of fuel feed pump primer anti-clockwise.
2. Keep pumping the primer until meet strong resistance to pumping. By holding the primer pushed down, loosen the bleeder screw of primary fuel filter, bleed out the fuel with air bubbles, then retighten the bleeder screw quickly.
3. Repeat (2) until pure fuel without air bubbles comes out.
4. Bleed secondary fuel and injection pump by doing the sequence (2), (3).
5. Bleed the air in injection pump, by the bleeder screw illustrated in the following figure.
6. After bleeding, push down the cap of primer and turn clockwise to be locked tightly.

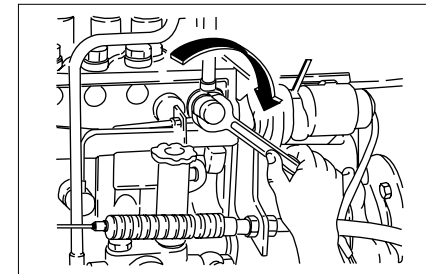
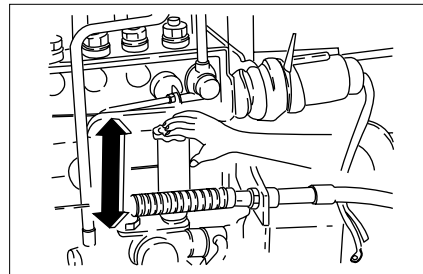

• Fuel system diagram
D1146 ENGINE

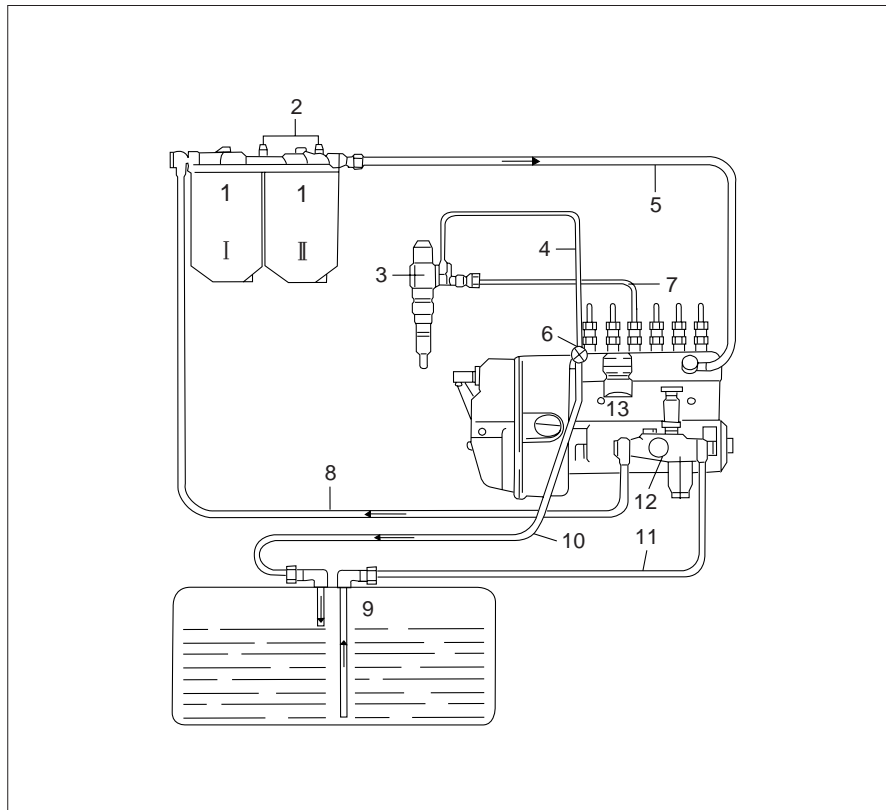

1. Fuel filter I, II
2. Air bleeder screw
3. Injection nozzle
4. Fuel return pipe
5. Fuel feed pipe
(filter → pump)
6. Overflow valve
7. Injection pipe
8. Fuel feed pipe
(pump → filter)
9. Fuel tank
10. Fuel return pipe
11. Fuel suction pipe
12. Fuel feed pump
13. Injection pump

DE12, DE08TiS ENGINE

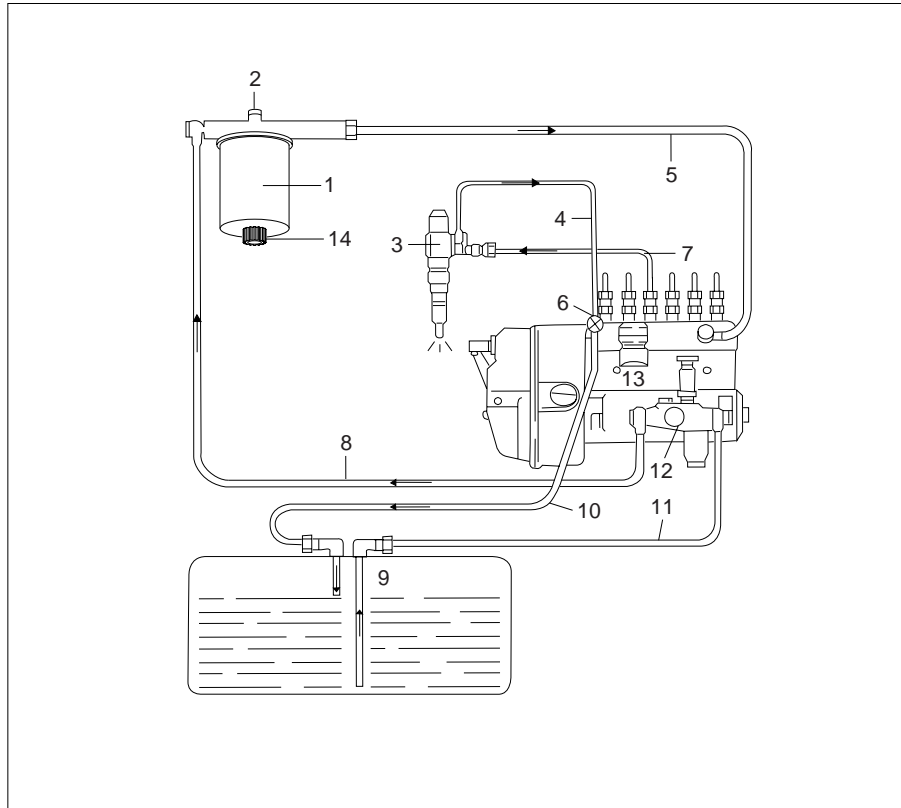

1. Fuel filter
2. Center bolt
3. Injection nozzle
4. Fuel return pipe
5. Fuel feed pipe
(filter → pump)
6. Overflow valve
7. Injection pipe
8. Fuel feed pipe
(pump → filter)
9. Fuel tank
10. Fuel return pipe
11. Fuel suction pipe
12. Fuel feed pump
13. Injection pump
14. Drain plug

Valve clearance adjustment

Adjustment intervals

Engine model	Change intervals
D1146	At end of first 1,000km, second : 2,500km Every 5,000km
DE08TiS DE12	At end of first 1,000km and Every 20,000km

Rated valve clearance (cold)

Engine model	Change intervals
D1146 DE12 DE08TiS	Intake 0.30mm, Exhaust 0.30mm

Adjustment of valve clearance

After removing the cylinder head covers, rotate the crank-shaft until the intake and exhaust valves of No. 6 cylinder are overlapped (water pump side).

Loosen the lock nut of one rocker arm adjusting screw of the cylinder indicated in the following chart (○).

Insert a thickness gage of specified thickness into the clearance between the valve stem end and rocker arm, then adjust the clearance with the adjusting screw.

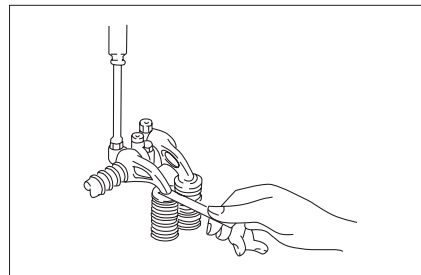

When the correct adjustment is obtained, fully tighten the lock nut. As same manner, adjust the clearances of the other valves(○).

Turn the crank-shaft 360°(the intake and exhaust valves of No. 1 cylinder are overlapped) and adjust the clearances of the valves (◎).

Valve clearance adjustment chart (DE ENG.)

1		2		3		4		5		6	
in	ex	in	ex	in	ex	in	ex	in	ex	in	ex
○	○	○			○	○			○		
			◎	◎			◎	◎		◎	◎

Injection nozzle

Check injection pressure and spray condition of injection nozzle at every 10,000km.

To check injection nozzle, specific nozzle tester is required.

Contact your nearest Daewoo dealer or repair workshop.

Engine model	Injection pressure
D1146	214kg/cm ²
DE08TiS DE12	220kg/cm ²

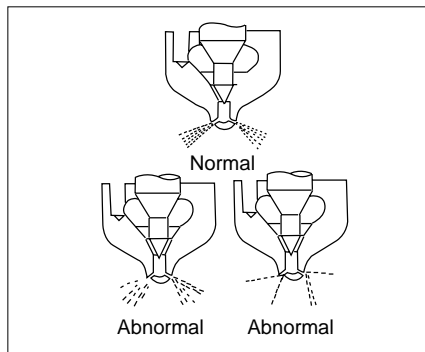

Points of handling care

Item	Description
Oil contamination	Be sure to use genuine oil and filter, keep periodical oil change.
Delay & lack of oil supplying	Prevent abrupt accelerating when idling and starting.
Foreign substances in intake air	Check air cleaner and keep to be clean.
Sudden engine stop after full load operation	Never stop the engine soon after full load operation, maintain engine idle about 3~5 minutes before engine stop.

Fuel tank

Every 8,000km drain water and remove sediments by removing the drain plug on the lower face of the fuel tank. Clean the inside of the tank every 24,000km.

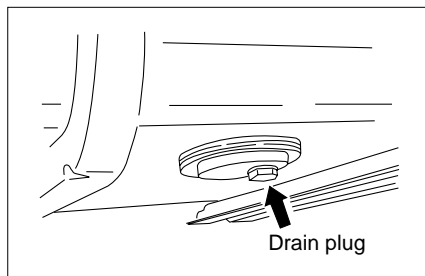

Belt installation

Check that the fan belt gives proper deflection when the intermediate part of the belt is depressed with finger. Also check the belt for cracks and damage.

CAUTION : *When belt replacement becomes necessary belts should be replaced by set.*

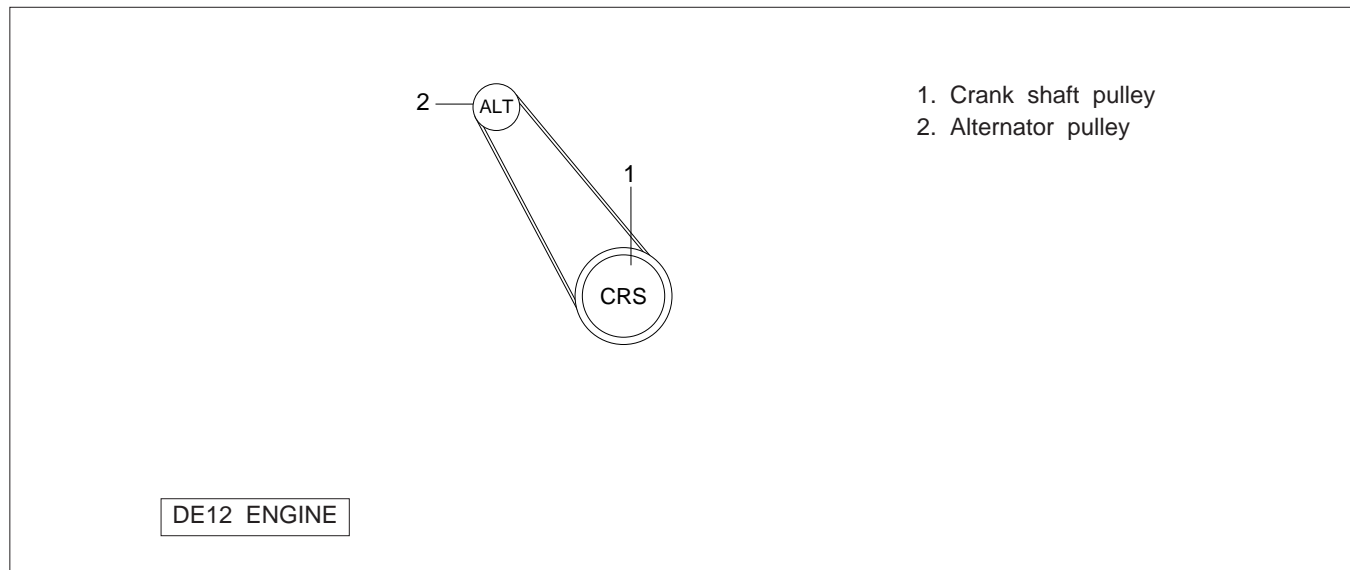

TENSION : The suitable tension is less than 10mm when pressed with the thumb.

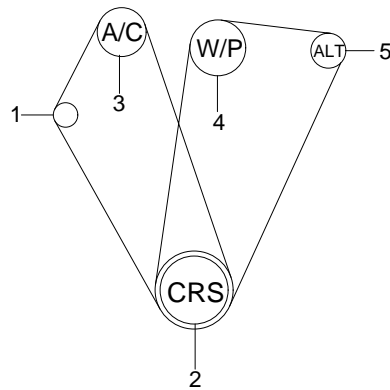

1. Idle pulley
2. Crank shaft pulley
3. Air compressor pulley
4. Water pump pulley
5. Alternator pulley

D1146, DE08TiS ENGINE

TENSION : The suitable tension is less than 10mm when pressed with the thumb.

Air cleaner

Regular service of the air cleaner is one of the most important maintenance items.

Neglecting of this service not only affects fuel consumption but also the performance and service life of the engine.

Inspection and service interval

The filter element should be cleaned at every 4,000km or when the red color signal appears on the indicator. Under severe conditions and operations on the dusty or sandy roads, it should be cleaned more frequently than the recommended intervals.

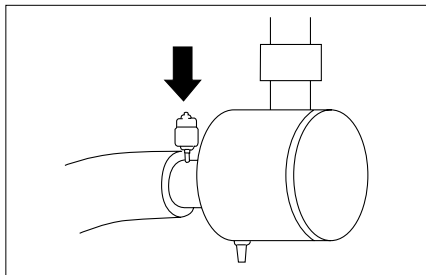

Replacement of element

Replace the element annually or after 3 times cleaning, also replace when any damages are found. Gaskets and sealings should be replaced together with the element.

Service of air cleaner

1. Disassembly

Loosen the clamping screws and remove the dust pan, then the element is exposed. Loosen the wing nut fixing the element and pull out the element.

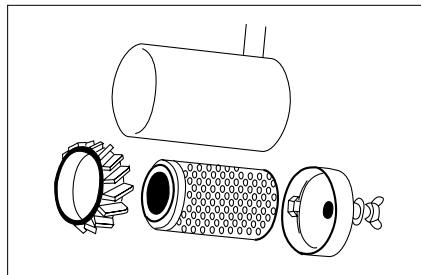

2. Cleaning of element

Depending on the condition of contamination, clean the element by one of the following procedure.

2-1. Element is contaminated(dry).
Blow dust off by compressed air(below 7kg/cm²), direction of compressed air should be from inside to outside of element.

2-2. Element is contaminated with carbon and oil.

First prepare element cleaner dissolved tepid water, submerge the element for 20~30minutes and shake well in the water, then rinse the element with clean running water (below 2.8kg/cm²).

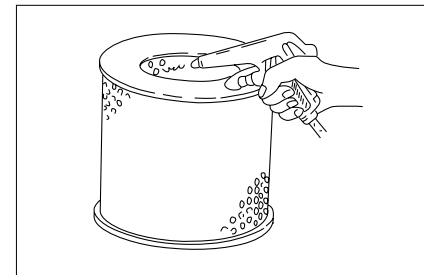

After washing, dry the element in the shade or place of good ventilation.

Drying of element takes 1 week, use spare element while drying.

Never apply compressed air or heat for quick drying

3. Inspection of element

After cleaning, inspect inside of element for tear, breakage and distortion, use lighting lamp for certain inspection.

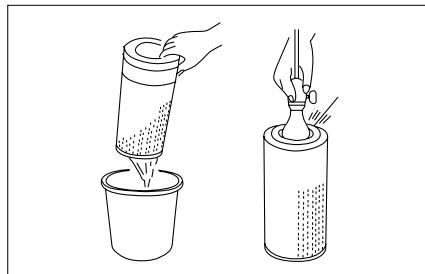

4. Cleaning of air cleaner housing

Discharge dust by opening the dust trap installed below the housing.

Clean inside of housing, cover and gasket fitting flange, if any damages are found replace the element.

Also the element should be replaced if the wall thickness is reduced to be broken easily.

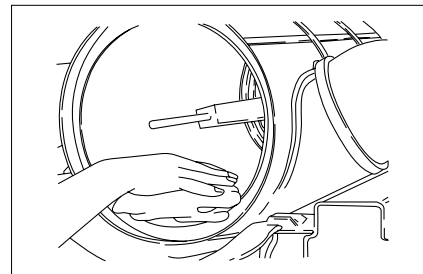

5. Reassembly

Reverse the disassembly sequence to reassemble, be sure to fit the element and gaskets, tighten the screws and nuts securely.

Finally push the button of the air cleaner element indicator to restore the signal to yellow from red.

NOTE

Do not neglect to extract out the accumulated dust from the dust trap installed at the bottom of air cleaner housing.

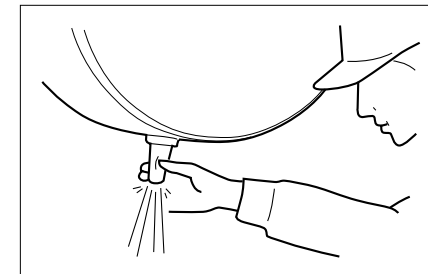

Transmission oil

Oil level check

Check oil level at end of first 1,000km and thereafter at every 4,000km driving by the filler/level plug.

If the oil level is below the level plug, replenish oil through the plug.

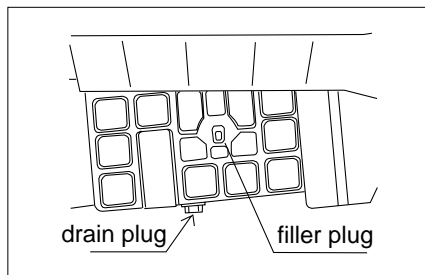

Changing oil

Replace transmission oil at end of first 5,000km and every 20,000km driving.

Oil replacement should be done while the used transmission oil is hot.

First drain the transmission oil by removing the drain plug at the bottom of the transmission housing.

After draining of used oil is completed, retighten the drain plug, then fill new oil through the filler/lever plug.

OIL CAPACITY

(Manual transmission)

TRANSMISSION	OIL CAPACITY
K805A K805P	9.8 l
T8HS5B T8HS5P	10.0 l
K806P	11.2 l
T8HS6P	12.0 l

(Auto transmission)

TRANSMISSION	OIL CAPACITY
MT643	25 l

Specification of oil

- Specification : API GL-4 or SAE 80W90
- Refer to "Lubrication list" at page 155.

Rear axle oil

Oil level check

Check oil level at end of first 1,000km and thereafter at every 4,000km driving by the filler/level plug.

If the oil level is below the level plug, replenish oil through the plug.

Changing oil

Replace rear axle at end of first 5,000km and every 20,000km driving. Oil replacement should be done while the rear axle is hot.

First drain the rear axle by removing the drain plug at the bottom of the rear axle housing.

After draining of used oil is completed, retighten the drain plug, then fill new oil through the filler/level plug.

Specification of oil

- Specification : API GL-5 or SAE 80W90
- Refer to "Lubrication list" at page 155.

OIL CAPACITY

- 11.5 – 12.5 l

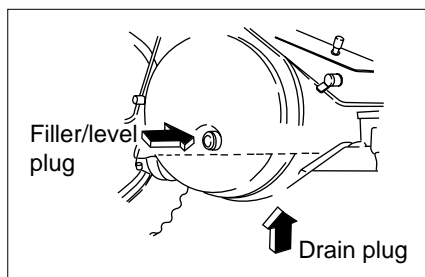

Power steering oil and filter

Oil level check

Check level by the mark on the oil reservoir at end of first 1,000km and thereafter at every 4,000km driving. Before checking power steering oil level, align the front wheels straight ahead.

Changing oil

Replace power steering oil at end of first 1,000km and every 24,000km driving by the following sequence.

1. With the engine stopped, raise front wheels until the tires have gap to the ground.
Use hydraulic jack or proper equipment to raise front wheels, be careful of the vehicle not to fall or slip while servicing.
2. Loosen the two tube fittings coupled at the upper side of steering unit and turn the steering wheel slowly in both directions.

3. After discharging of used fluid, retighten the tube fittings securely. Then fill the reservoir with new oil to the specified level.
4. Retighten the cap of reservoir and wait 2~3 minutes, then lower the front wheels to the ground.
5. Start engine and keep idling for 2 ~ 3 minutes. Recheck the fluid level while the engine is idling and replenish as necessary.
6. After changing oil or if unusual sound is heard when the steering wheel is turned, perform air bleeding, refer following paragraph, "air bleeding of power steering unit".



OIL CAPACITY

VEHICLE	OIL CAPACITY
BF106	5 l

Air bleeding of power steering unit

1. With the engine stopped, raise front wheels until the tires have gap to the ground. Use hydraulic jack or proper equipment to raise front wheels, be careful of the vehicle not to fall or slip while servicing.
2. Remove the cap from the bleeder screw on the upper side of the steering unit. Prepare vinyl tube, connect one end of the vinyl tube to the bleeder screw and the other end to a transparent container.
3. After starting engine, turn the steering wheel right-hand direction to lock, then loosen the bleeder screw to discharge the fluid mixed with air bubbles. Soon after the fluid with air bubbles are forced out, retighten the bleeder screw.
4. Turn the steering wheel to left-hand direction and bleed air.
5. Repeat air bleeding until the air is removed sufficiently. While bleeding, check fluid level and replenish if necessary. After bleeding, reinstall the cap on the bleeder screw and lower the wheels on the ground. Check the level again and leakage of fluid.
6. Test the vehicle on the road that steering is smooth and abnormal noise is not heard.

Specification of oil

- Specification : AFT(DEXRON II)
- Refer to "Lubrication list" at page 155.

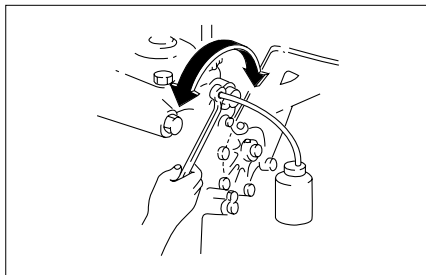

Changing oil filter element

Oil filter element(paper type) should be changed at the same time when the power steering oil is changed, except at the first 1,000km driving.

Change the oil filter element at every 24,000km thereafter.

To change, drain the oil in the reservoir and turn the cap of reservoir counter-clockwise.

Pull out the oil filter element and change to new one.

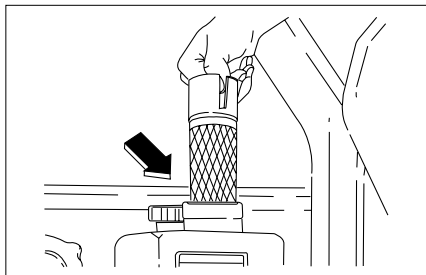

Cleaning oil strainer

Prior to changing steering oil or filter element, oil strainer installed in the filler of oil tank shall be cleaned. Remove dust or other foreign matters from the oil strainer before reinstalling it.

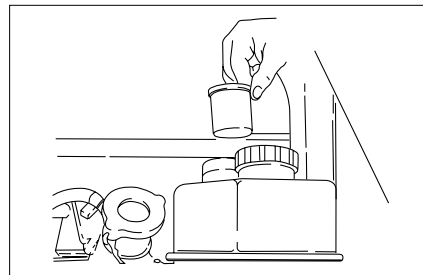

Brake system

Adjustment of brake pedal free play

Adjust the brake pedal free play by turning the adjust screw installed at the lower side of pedal. Free play is the stroke measured at the upper tip of pedal from released position to the contact point between the brake pedal and valve stem.

NOTE

Free play of brake pedal remains unchanged under normal condition, however, check the free play and adjust to the specified stroke, because insufficient free play could make brake dragging.

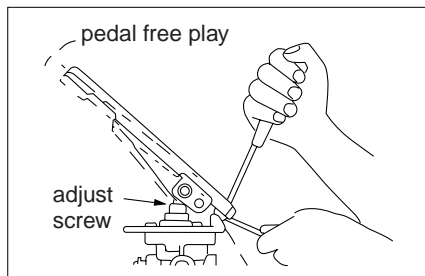

Brake valve check

Check the brake pedal move smoothly and return to the normal position without any sticking. Also check the brake valve that air discharging sound is heard when the brake pedal is released, this check should be performed when the pressure of air tank is about 7.0kg/cm².

Adjustment of brake lining clearance

Check and adjust the clearance between the brake lining and drum at the first 500km operation and every month, or when the brake pilot lamp turns on.

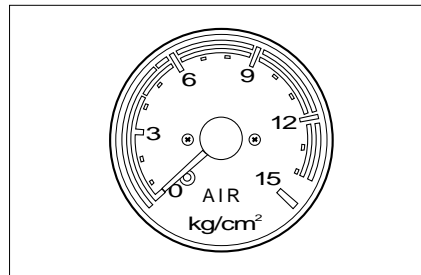

Adjustment procedure

A.O.H brake

1. Jack up and check the wheels rotate smoothly without any resistance.
2. Remove the rubber plug fitted in the brake lining inspection hole.
3. By rotating the wheel by hand, turn the adjusting cam to the direction in which the brake shoe expands until the brake drum drags by contacting with the brake lining, then turn the cam to reverse direction until the clearance becomes the standard value.

The standard clearance is 0.3mm, check the clearance by inserting the thickness gage between the brake lining and drum through the inspection hole.

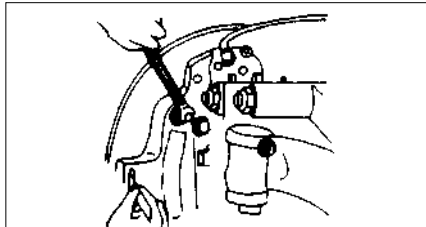

Full air brake with mechanical slack-adjuster (OPTION)

1. With scale, measure the travel length of brake chamber push-rod from the released position to the fully depressed position, if the measured value exceeds the standard (front : 33~35mm, rear : 35~38mm), adjust the clearance.
2. Jack up and check the wheels rotate smoothly without any resistance.
3. Remove the rubber plug fitted in the brake lining inspection hole.
4. By rotating the wheel with hand, turn the worm-shaft of the slack-adjuster to the direction in which the brake shoe expands until the brake drum drags by contacting with the brake lining,

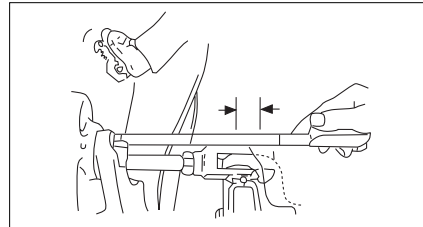

then turn the worm-shaft to reverse direction until the clearance becomes to the standard value.

The standard clearance is 0.3mm, check the clearance by inserting the thickness gage between the brake lining and drum.

5. After adjustment, check again that the brake chamber push-rod travel length is front : 33~35mm, rear : 35~38mm.

NOTE

If the protruded point of the indicator comes into contact with the stopper by turning the worm-shaft for adjustment, it indicated that the lining has been worn to the limit and should be replaced.

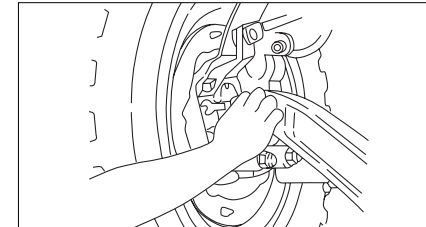

Inspection of brake lining

1. Remove the rubber plug fitted in the brake lining inspection hole.
2. Check the condition and amount of brake lining wear by the eyes. If the brake lining wore out to the stepped line, also any cracks, severely burnt spots or abnormal conditions are checked, replaced the brake lining to the new one.

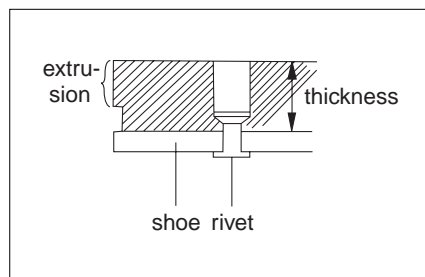

Brake oil for A.O.H brake

1. Check the level of the brake oil reservoir and replenish if necessary. If the level is too low or the level goes down fastly even after replenishment, inspect the hydraulic circuit of the brake oil and have service at your nearest Daewoo dealer.
2. When brake oil is found to be contaminated, inspect and repair if necessary, before refilling, drain the contaminated oil thoroughly.
3. Change brake oil at every 60,000km operation or 1 year.

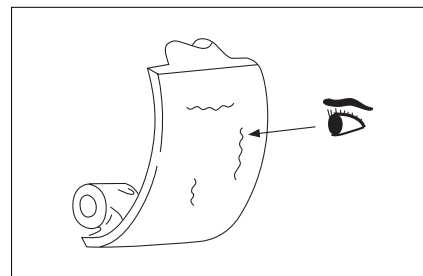

**Parking brake adjustment
(For AOH brake)**

The parking brake lever travel is normal when it is within 5~7 notches as the lever is pulled out fully. If the brake lever travel exceeds 10 notches, parking brake action is limited and adjustment should be made in the following manner.

1. Brace the front wheels and fully release the parking brake lever.
2. Jack up the rear wheels clear of the ground and hold the transmission in neutral. Bring the adjusting hole in the brake drum into alignment with the adjuster by turning the propeller shaft as necessary with hand.
3. Insert a screw driver into the adjusting hole in the brake drum and turn the adjuster upward to stop.
4. Then, back off the adjuster 8 notches. When the above steps of adjustment are completed, the clearances between the brake linings and drum are adjusted to the standard value, normalizing the brake lever travel.

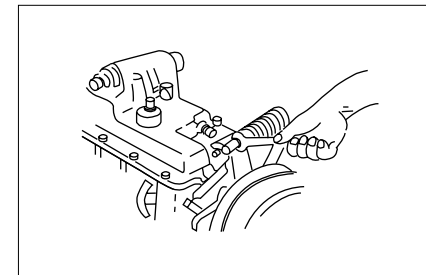
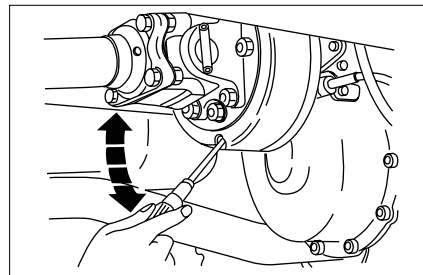
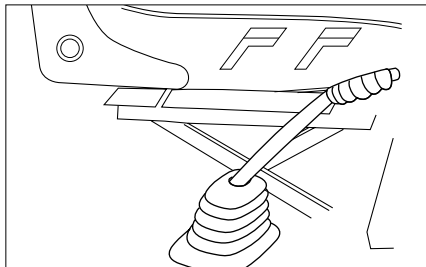

Clutch system (Except auto transmission)

Adjustment of clutch pedal free play

The clutch pedal free play decreases as wear develops in the clutch driven plate. The clutch pedal free play should be adjusted in the following manner when the amount of play becomes less than 25mm, using the vehicle without adjustment result in clutch slip.

1. Free play : 25~30mm
2. Height : 180~205mm

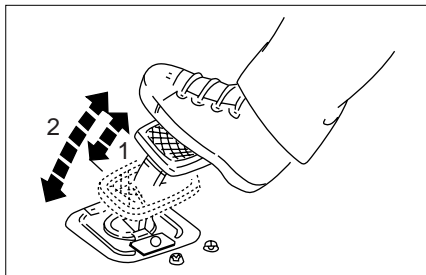

Inspection of free play

To check the amount of clutch pedal free play, release air within the main air tank solely to interrupt booster operation. Depress the clutch pedal carefully until a strong resistance is felt, then check the free stroke before the point of resistance is reached.

Adjustment procedure

1. Disconnect the return spring on the mainpack, then remove the bellows at the minipack side.
2. Loosen the minipack push-rod lock nut and slowly turn the push-rod in direction of extension until a strong resistance is felt, then back off the push-rod 1~2/3 turns.

NOTE

When turning the push-rod, avoid excess force, or adjust within the point at which resistance increases can not be felt.

3. Tighten the lock nut and install the return spring and bellows.
The clutch pedal free play is adjusted from 25 to 30mm when the above adjustment procedure is followed.

NOTE

When the adjustment operation is completed, check that clutch pedal is provided with standard free play.

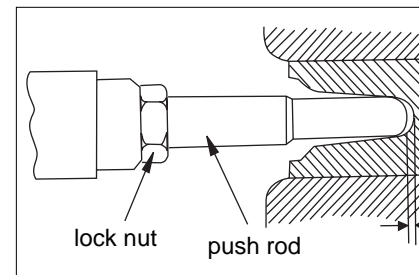

Clutch oil

Check to see if the level of oil in the reservoir is normal. When the level is too low, check the circuit for possible leakage and replenish with specified oil. The clutch hydraulic circuit should be drained and refilled when fluid is found to be contaminated. Oil change intervals : every 60,000km or 1 year.

NOTE

Any fluid other than clutch fluid should not be used for replenishment.

Bleeding of clutch hydraulic circuits

If air enters the clutch circuit, it cause clutch dragging. Therefore, bleeding operating should be performed if the clutch fluid reservoir has been emptied due to failure or if the hydraulic circuit has been disassembled.

Bleeding operation calls for cooperative action of 2 men.

1. Set the parking brake.

Bleeding of clutch hydraulic circuit should be performed with the air tank emptied.

2. Check the level of clutch fluid in the reservoir and replenish as necessary.

3. Remove the rubber cap from the bleeder screw on the clutch mini-pack and clean the screw. Connect a vinyl tube to the bleeder screw and insert the other end of the vinyl tube into a transparent container.

4. Pump the clutch pedal repeatedly and hold it depressed.

5. Loosen the bleeder screw to release clutch fluid with air bubbles into the container and tighten the bleeder screw immediately.

6. Release the clutch pedal carefully. Repeat the above operation until air bubbles disappear from the clutch fluid being pumped out into the container. During the bleeding operation, keep the clutch fluid reservoir filled to the specified level. Reinstall the rubber cap.

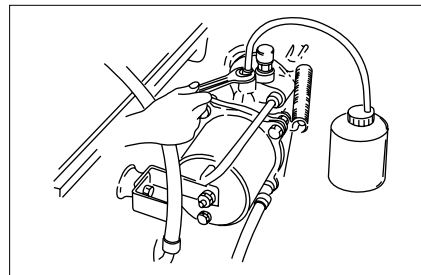

Method of operation

Charging position

Control piston(6) and cut-out piston(2) are held in their lower or upper end positions, respectively, by compression springs(7) and (14), so that outlet(1) and inlet(8) are closed while outlet(3) is open.

One half of the air supplied by the compressor flows through port 1 and screen(12)–where coarse impurities such as oil carbon are retained–and on to check valve(10); it opens the latter valve and flows via port 21 into the pipeline to the supply air reservoirs; at the same time, air is fed through passage(9) to act upon control piston(6). The other half of the air supplied also travels to the supply air reservoirs, though by way of the relief valve AE13..(15).

Cut-out

As the pressure in the supply air reservoirs rises, the same pressure builds up below control piston(6), via passage(9), causing this piston to move upwards. The spring-loaded valve plunger(5) follows this movement until outlet(3) is closed. When the pre-determined cut-out pressure has been reached, control piston(6) lifts off valve plunger(5), and inlet(8) opens; compressed air passes down through the drilling in valve plunger(5) to act upon cut-out piston(2), and it is also communicated, via port 23, to the control device of relief valve(15).

Cut-out piston(2) is moved downwards, thereby opening outlet(1) so that air continuously supplied by the compressor exhausts to atmosphere, through exhaust port 3, taking with it any oil carbon particles that may have accumulated. As a result of the control pulse fed in from port 23, the air supplied via relief valve(15) is also discharged to atmosphere.

Cut-in

When, as a result of air being withdrawn, the pressure in the supply air reservoirs and thus the pressure in the chamber below control piston(6) drops to cut-in pressure, the spring loaded control piston(6) closes inlet(8) while outlet(3) opens; the pressure prevailing above cut-out piston(2) and, via port 23, in the control pipeline to relief valve (15) is reduced through port(4). Compression spring(14) causes cut-out piston(2) to move upwards until outlet(1) is closed. The air supplied by the compressor is allowed to travel again through ports 21 of both the unloader valve and the relief valve(15) to the supply air reservoirs.

Safety valve

In the event of the unloader valve not cutting out, due to a malfunction, safety valve(11) will limit the supply air reservoir pressure by allowing the air supplied to exhaust to atmosphere when the opening pressure has been reached.

Tyre inflation

This unloader valve range is generally not provided with an integral tyre inflation valve.

A tyre inflation valve of the ZB 31.. range can, however, be fitted in either of the delivery lines between the compressor and the unloader or relief valve.

Breather valve(13) is only required with unloader valves having an integral tyre inflation port(see DR 3000-K 11EN); it has only been fitted for parts commonality. It is of no significance to the operation of the unloader valve described in the present catalogue sheet.

Installation

Unloader valve and relief valve are mounted in an upright position, with exhaust port 3 pointing downwards.

The total volume of air supplied by the compressor must be allocated to two 18×1.5 pipelines, one line being connected to port 1 of the unloader valve and the other one to port 1 of the relief valve(see installation diagram). The pipelines should have a length of approx. 2m each(if necessary, to be coiled) and must be laid in such a manner that the temperature at ports 1 of both the unloader valve and the relief valve does not exceed 150°C.

For the control line from port 23 of the unloader valve to port 4 of the relief valve use either a pressure/temperature-resistant hose with an inside diameter of 6mm, with fitting to suit dimensions as shown in drawing I, or a 6×1 pipe with connection to suit dimensional drawing II. In both cases a maximum length of 1 m should not be exceeded.

The pressure relief noise generated in the cut-out phase is reduced by means of hoses attached to the exhaust connections 3 of both the unloader valve and the relief valve; this can also serve to drain off any oil that may have been separated.

Installation diagram

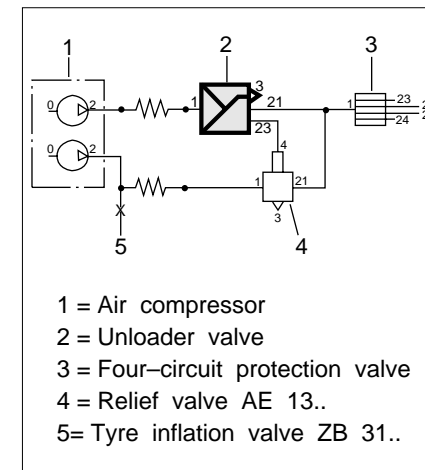

Maintenance

After a prolonged period of operation, the cut-out pressure may vary from the specified value. Turning the spring housing allows the precompression of spring(7) and thus the cut-out pressure to be adjusted.

This operation should only be carried out by trained specialists.

Technical features

Type no.	Dimensional drawing	Graphic symbol (see overleaf)	Max. cut-out pressure	Min. cut-in pressure	Safety valve opening pressure
–	–	–	bar	bar	bar
DR 3218	I	1	7.35 ± 0.2	6.2	N/A
DR 3226	I	1	10.00 ± 0.2	9.0	N/A
DR 3227	I	1	8.10 ± 0.2	7.1	N/A
DR 3242	II	2	9.50 ± 0.2	8.6	10.5
DR 3243	I	1	8.50 ± 0.2	7.3	N/A
Accessory valve required : Relief valve AE 13.. according to catalogue sheet AE 1000–K 14 EN					
Temperature range :		–40°C to +150°C			
Weight :		0.9kg			

ANTIFREEZE PUMP (OPTION)

Application

The antifreeze pump is used in brake systems in order to inject an anti-freeze based on glycol or alcohol during winter operation. This makes it unnecessary to unscrew the pipe connection. If the vehicle is operated without trailer, the pump must be actuated one or several times before sitting off, the number of strokes being dependent on the temperature and humidity of the air(see instruction plate on reservoir).

In case the vehicle is operated with trailer with a consequently higher air consumption, the plunger rod must accordingly be depressed more often.

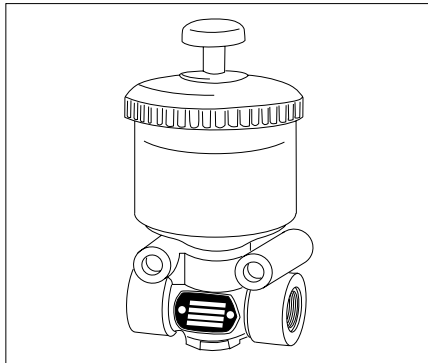

Mode of operation

When the pump is inoperative, cylinder(6) communicates via the feed holes(5) with reservoir(2) containing the antifreeze. When plunger rod(1) is depressed, piston(4) moves downwards, closing feed holes(5) and causing approx. 1cm³ of antifreeze to be injected into the air stream, via check valve(7). As long as plunger rod(1) is in the operating position, the further flow of fluid of from reservoir(2) is interrupted. When plunger rod(1) and piston(4) are released, they are moved back to their original positions, due to the action of return spring(3). Compression spring(8) closes check valve(7), and cylinder(6) is again filled with antifreeze through feed holes(5). At any further stroke, prior to setting off and with the compressor in operation, appr. 1 cm³ of antifreeze per stroke is fed into the air stream. Following any pump operation, several brake applications must be made.

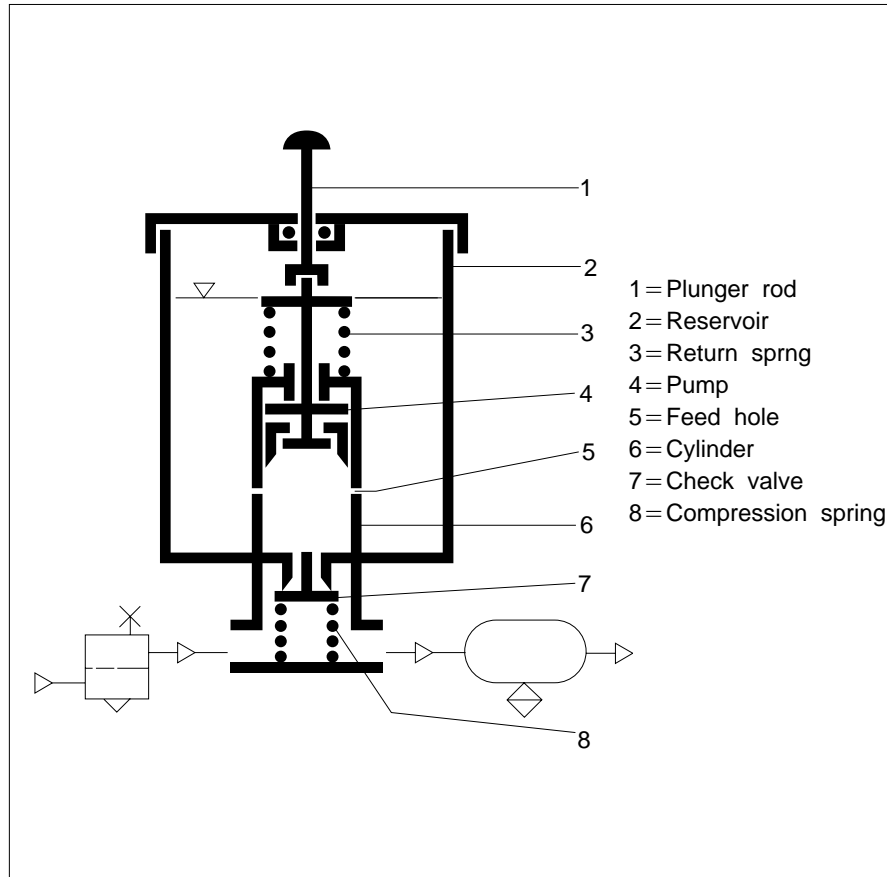

Installation

The antifreeze pump is installed in the delivery line between the unloader valve and the air reservoir, either close to the unloader valve or upstream of the air reservoir. The pump must be installed in a vertical position and sufficient clearance be allowed for operation and refilling. Only manual operation is permissible. The pipe line to the air reservoir should slightly slope downwards to ensure that the antifreeze flows immediately and at all events into the brake system.

The antifreeze pump is fastened by means of two M8 bolts.

Maintenance

After winter operation the antifreeze pump must be cleaned and sprayed with acid-free oil.

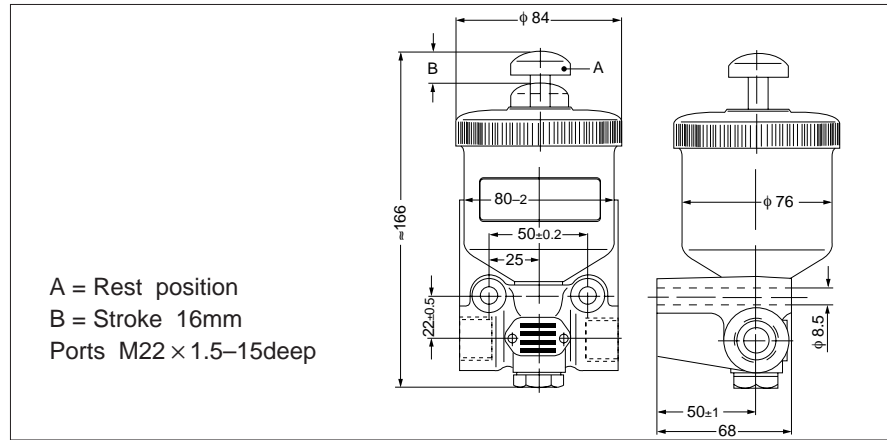

Technical features

Type no.	Antifreeze	Paint coating	Weight [kg]
LA 1100	on an alcohol or glycol basis or pure alcohol.	no	1.3
LA 1101	No methyl alcohol-toxic!	yes	1.3
Max. operating pressure : 10 bar(gauge pressuree)			
Temperature range : -40°C to +80°C			
Reservoir capacity : 250 cm ³			
Reservoir : transparent			

AIR DRYER (OPTION)

Function of air dryer

Since moisture contained in the atmosphere is compressed and warmed by the air compressor, the amount of moisture is in proportion to that of compressed air.

This hot and humid air is cooled down in reserve tanks or pipings to form condensation. This condensation washes away lubricants from the moving parts of various devices or equipment, resulting in unsatisfactory actions of these devices or equipment. In addition, impurities contained in the condensation accelerates rusting action to shorten the lives of related devices or equipment. In cold weather, this condensation can be frozen and immobilize various devices and equipment. Therefore, it is essential to remove moisture from compressed air in order to extend the service lives of devices, to enhance reliability, and to prevent possible damage or breaks.

Specifications

Item	Description	Remarks
Max. air pressure	9.8kg/cm ²	
Normal air pressure	5~9.8kg/cm ²	
Dew point	17°C	
Remaking time	50 sec	
Air compressor displacement	600L/min or less	
Heater capacity	24V/50W	
Temperature range	- 30°C ~ +70°C	
Thermostat temp.	4±4°C	
Operation fluid	Air	
Delivery	581L/min	

Operation of air dryer

Season	Descriptions
Spring, Summer, Autumn (warm or hot weather)	Before driving, always check the air pressure(8.2kg/cm ²) in air tank.
	When parking, check the amount of drained water and foreign substances in water.
Winter (cold weather)	As thermostat is installed in air dryer, when the sensing temperature is above 4±4°C, the electric current to heater is cut off automatically.
	Before or after the operation, always follow the above instructions 1 and 2 to take care for the air tank.

* In the case that temperature drop in air tank exceeds 16°C, a small amount of water may be drained.

Inspection of air dryer

- At end of every 15,000km or 2months operation.
Check for the drain amount and outflow of oil when draining condensation and dirts from air tank.(When oil is detected, check compressor.)
- At end of every 45,000km or 6 monthes operation
Disassemble air dryer and check if dessicant has been moistened by dirts. If the dessicant is found to be wet for about more than 1/5 of all, change it(In wet condition, the capacity drops).
- At end of every 90,000km or 1 year operation.
Disassemble air dryer and change dessicant, oil filter, cloth filter and whole rubber parts.
Check air tubing and wiring connections.

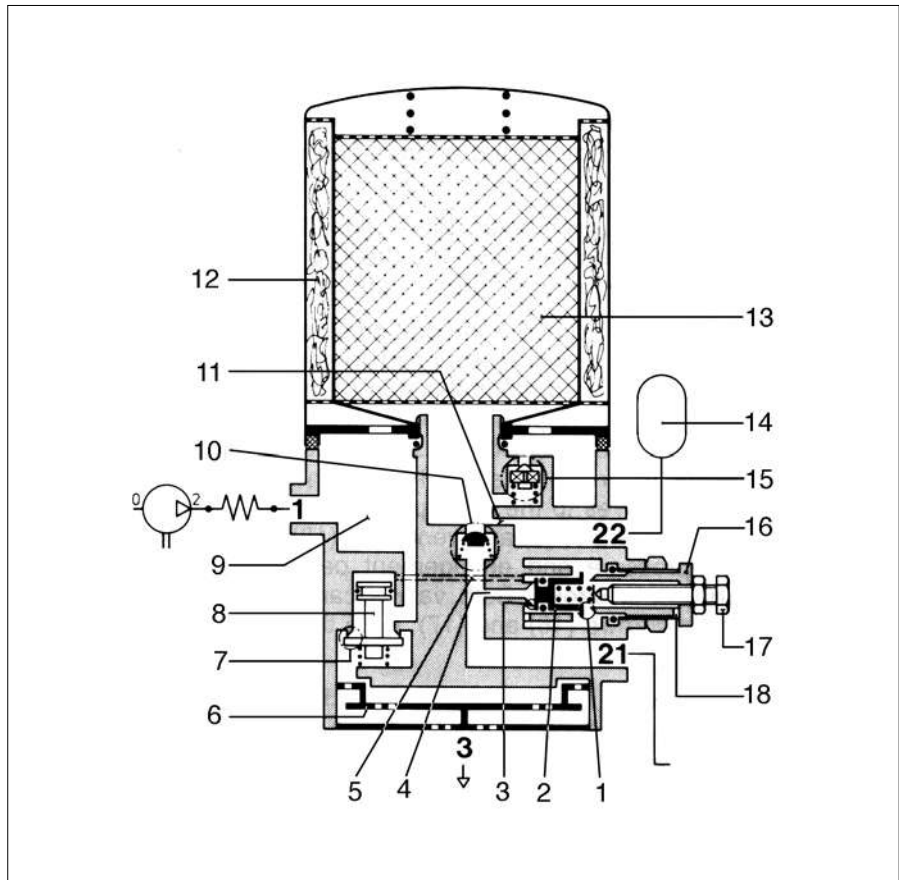

- 1. Outlet
 - 2. Control piston
 - 3. Inlet
 - 4. Bore
 - 5. Bore
 - 6. Silencer
 - 7. Outlet
 - 8. Blow-off valve
 - 9. Preliminary dewatering chamber
 - 10. Non-return valve
 - 11. Nozzle
 - 12. Ring filter
 - 13. Desiccant
 - 14. Regeneration air tank
 - 15. Bypass valve
 - 16. Adjusting screw
 - 17. Adjusting screw
 - 18. Vent bore
- Connections
- 1. Energy inlet
 - 21. Energy outlet (to energy accumulator)
 - 22. Energy outlet (to regeneration air tank)
 - 3. Vent

Trouble shooting

Daily inspection and periodic inspections will prevent the greater portion of air dryer troubles.

In the event of troubles or complaints as listed, follow the correction procedures to correct the difficulty.

Complaints	Cause	Correction
Water comes out from main tank.	Desiccant has been saturated.	Check and drain the main tank until the desiccant is dried up.
	Cut-off pressure of governor is so low that purge valve won't open.	Increase pressure for governor to 6kg/cm ² or higher.
	Failure to change desiccant or oil filter within scheduled period.	Change desiccant kit at end of every 12 months or 90,000km operation.
	As the purge time is less than the rated time (50 seconds), desiccant is not recovered sufficiently)	1. If cut-off pressure of governor and closing pressure of relief valve are low, purge time also is shortened, resulting in failure in recovery of the desiccant. 2. In the case of purge by relief valve, if cut-off pressure of governor and closing pressure of relief valve are low, purge time also is shortened, resulting in failure in recovery of the desiccant.
Drain valve fails to drain.	Freezing of air dryer due to heater trouble	1. Change faulty heater. 2. When the trouble is located in thermostat, change it.
	Failure to regularly change desiccant	Change desiccant kit at end of every 12 months or 90,000km operation.
	No operation of purge valve due to the entry of foreign substances into drain valve.	Disassemble and check the valve, and replace the valve, if necessary.

Complaints	Cause	Correction
Inside of air dryer has been frozen	Misattached dryer body or exposed to cold weather at - 30°C while traveling	Correct the position of dryer body or install a wind screen.
	Heater has been short-circuited and no heating	1. Use a tester to check the heater for short-circuit. 2. If heater has been short out, change it with a new one.
	Thermostat has been short, resulting in failure of heater.	Leave thermostat at temperature of 0°C or below and use a tester to check it. Add heat to thermostat by hand to check for OFF state and change it if required.
	The dryers temperature drops significantly due to ice or snow stuck to its body	Remove ice or snow so carefully as not to cause damage to dryer body and electrical wiring connections for heater.
	No operation of heater due to disconnection of the electrical wiring for heater or thermostat	Check heater and thermostat for connection.
Air leaks from drain valve	Poor contact of valve seat due to the entry of foreign substances into valve	Disassemble and check the valve, and change the valve kit if required. When damage is found at the wet moving part of valve body, change the valve.
Excessively low pressure of main tank	When the check valve of main tank fails to perform backward flow checking operation with compressor in unload cycle, air can be leaked through the main tank drain.	Disassemble and check the check valve located between main tank and purge tank, and change it if required.

WATER TRAP (OPTION)

Installation of water trap

Water trap is always located between pressure regulator and main air tank. When the air dryer is installed, and if the pressure regulator is not used, at that case the water trap should be installed before air dryer.

The function of water trap

As shown at the above drawing, the water trap condensate the moisture and lubricant mixed at the compressed air from the air compressor. The vapor molecules are condensed while they pass out the 12- ϕ 5 holes in the closed plate of water trap, and they can be drained through the drain cock at the bottom of water trap.

The effect of condensation could be increased when the antifreeze pump is used before the water trap.

Because, the alcohol molecule draw the water molecules and make water drops easily.

NOTICE

Every driver should pull the drain cock to drain off the condensates in the water trap before and after you drive, especially below the temperature of freezing point.

With pressure regulator

1. Pressure Regulator
2. Hose
3. Water trap

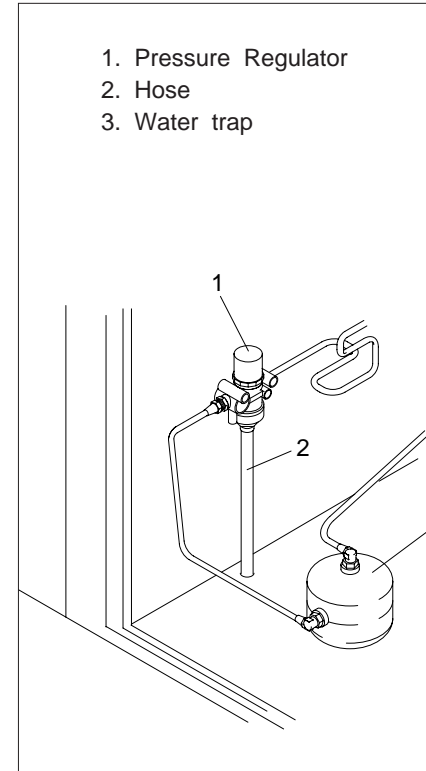

With anti freeze pump(OPT)

1. Pressure Regulator
2. Anti freeze pump
3. Hose
4. Water trap

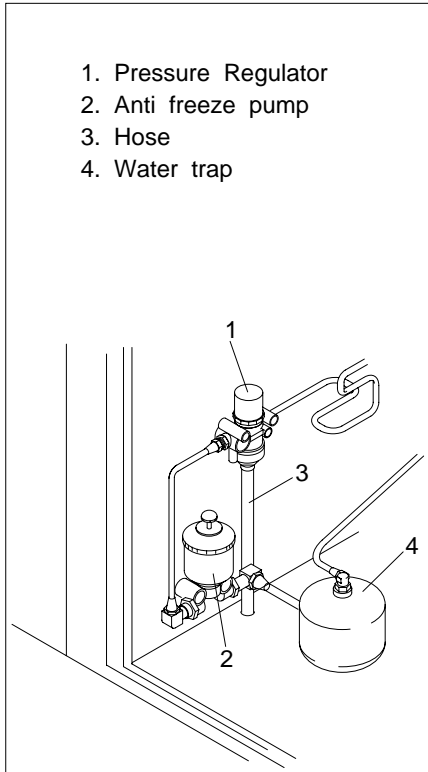

With air dryer(OPTION)

1. Air dryer
2. Hose
3. Regenerating tank

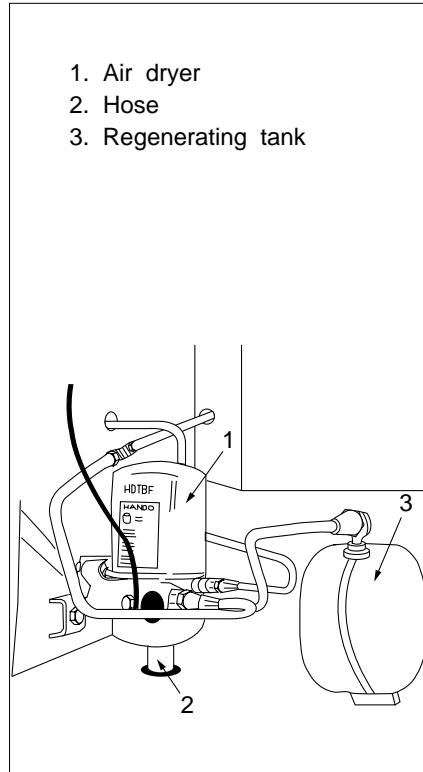

TIRES

Tire pressure inspection

Check tire pressure with air gauge and add compressed air if required. Improper inflation will adversely affect the life of tire, especially underinflation is a major contributor to overheating of tire, resulting in explosion.

Tire air pressure

Tire size	Normal inflation pressure in kg/cm ² (PSI)
10.00-20-16PR (Tube)	Front : 8.1kg/cm ² (115PSI)
10.00R-20-16PR (Tube, radial)	Rear : 7.4kg/cm ² (105PSI)
11.00-20-16PR (Tube)	Front : 8.4kg/cm ² (119PSI)
11.00R-20-16PR (Tube, radial)	Rear : 7.7kg/cm ² (109PSI)

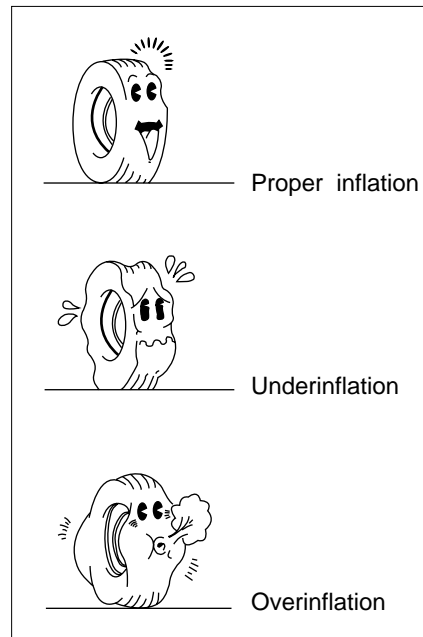

Tire rotation

Tire wear depends on tire position, road conditions, or a habit of applying brakes.

To avoid unbalanced wear of your tires and to prolong their lives, rotate tires periodically (every 5,000km normally).

Type A

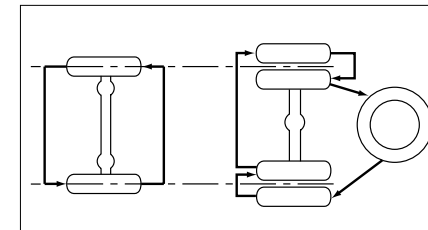

Type B

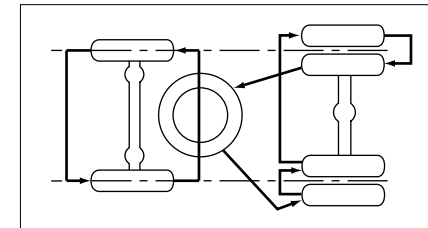

Following these instructions with-care when rotating tires.

1. The wheel nuts on the right side wheels have right-hand threads and the wheel nuts on the left side wheels have left-hand threads.

2. Clean the wheel pins and nuts and apply oil to the threads.

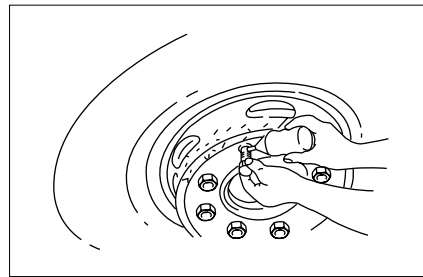

CAUTION

After rotating tires, be sure to retighten the wheel nuts to specified torque at end of 50~10km running. (Torque : 60~65kg·m)

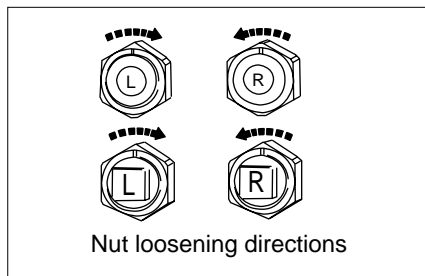

3. Place hydraulic jack shown.

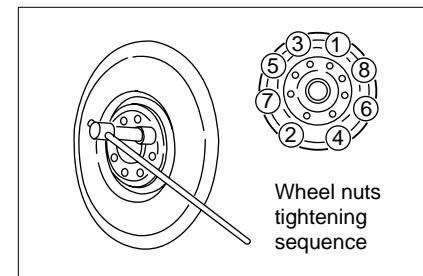
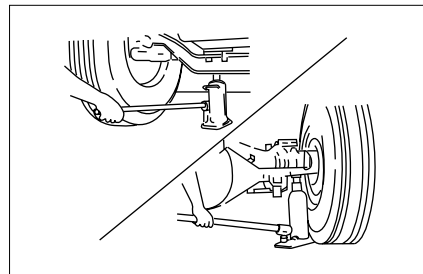

ELECTRICAL

Aiming of headlamps

The headlamps should be tested and properly aimed if found to be out of adjustment. The headlamps can be properly aimed using either the headlamp aimers or a headlamp tester. The headlamp testers include focus type and screen type. To aim headlamps, proceed as follows: Park the vehicle on a level floor and check tire inflation pressure and adjust as necessary. Remove the headlamp covers and wipe clean the lenses.

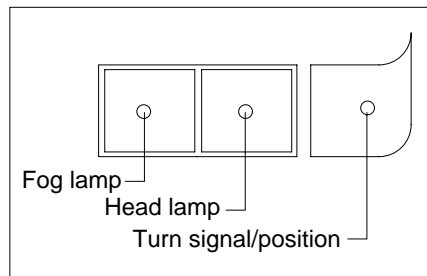

- Adjustment by the use of an aiming instrument
One aiming instrument consists of two units: one is for right side and the other is for left side.

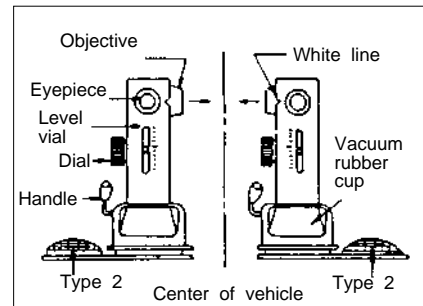

- 1) Place the right and left units of the aiming instrument on the headlamps (type 1—inside, type 2—outside) in such a manner that the right and left units of the aiming instrument lightly contact the aiming bosses on the headlamp lenses.

Support the aiming instrument so that the objective lens of the aiming instrument is faced to the center of the vehicle, and push the handle strongly to tightly contact the vacuum rubber cup of the instrument on the lens.

- 2) Look into the eyepiece of the aiming instrument, and adjust the left and right adjust screws so that the standard line seen in the instrument is correctly overlapped on the white line of the other side aiming unit. (This adjustment is the same for both type 1 and type 2.)
- 3) Next, set the dial of the level vial to the desired angle (0 deg for type 1 and 0.5 deg for type 2), and adjust the updown adjust screws of the headlamps so that air bubble in the level vial is in center of the level vial.
- 4) Thus, driving beam of the type 1 headlamp is tilted downward 0.5 deg, and passing beam of the type 2 is tilted downward 2 deg and turned 0.5 deg to the left side.

- Adjustment by the use of a screen
Support a screen vertically in position 3 meters ahead of the headlamps and adjust the beam to the values given in the table below.
(Keep the headlamps on one side covered with a suitable cloth when making adjustment.)
Adjustment of beam relative to the line in the center of headlamps.

A	Type1	26mm below horizontal line
B	Type2 (low beam)	105mm below horizontal line
B'	Type2 (low beam)	26mm swung to the right (RHD, left)

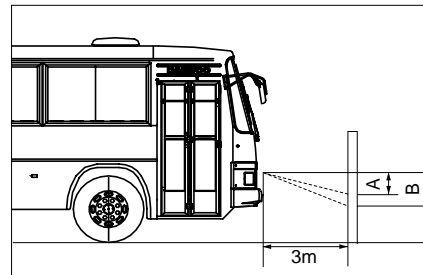

Bulb

DISTINCTION		BF106
Head lamp	High	75/70W(H ₄) × 2
	Low	
Front combination lamp	Fog	70W(H ₃) × 2
	Cornering	–
	Parking/turning	–
	Position	–
	Parking (OPTION)	3W × 2
	Turning/Position	25/10W × 2
	Turning	–
Rear combination lamp	Fog	–
	Turning	25W × 2
	Stop/position	25/10W × 2
	Stop/parking	25W × 2
	Stop	–
	Parking (OPTION)	3W × 2
	Position	–
Destination lamp (OPT)	Front	12W × 2
	Middle	–
	Rear	–

DISTINCTION	BF106
Side turn signal	12W × 2 / 12W × 4
Back up lamp	21W × 2
NO. Plate lamp	12W × 2
Engine Room lamp	–
Speed indicator lamp (OPTION)	12W × 3
Driver lamp	12W
Room lamp (FL)	20W × 6
Room lamp (GLOW)	12W × 6
Front marker lamp	12W × 2
Rear marker lamp	12W × 2
Side marker lamp	–
Step lamp (OPTION)	12W
Search lamp (OPTION)	12W
Luggage lamp (OPTION)	12W
Reading lamp (OPTION)	–
Pilot lamp	1.2W × 32
Side lamp (OPTION)	12W × 2
Warning lamp (OPTION)	–

Relay and fuse layout

★ The quantities or locations of fuses could be different from the figure, because the fuses or relay could be added or omitted, and locations could be changed by the requirement of customers.

Type A

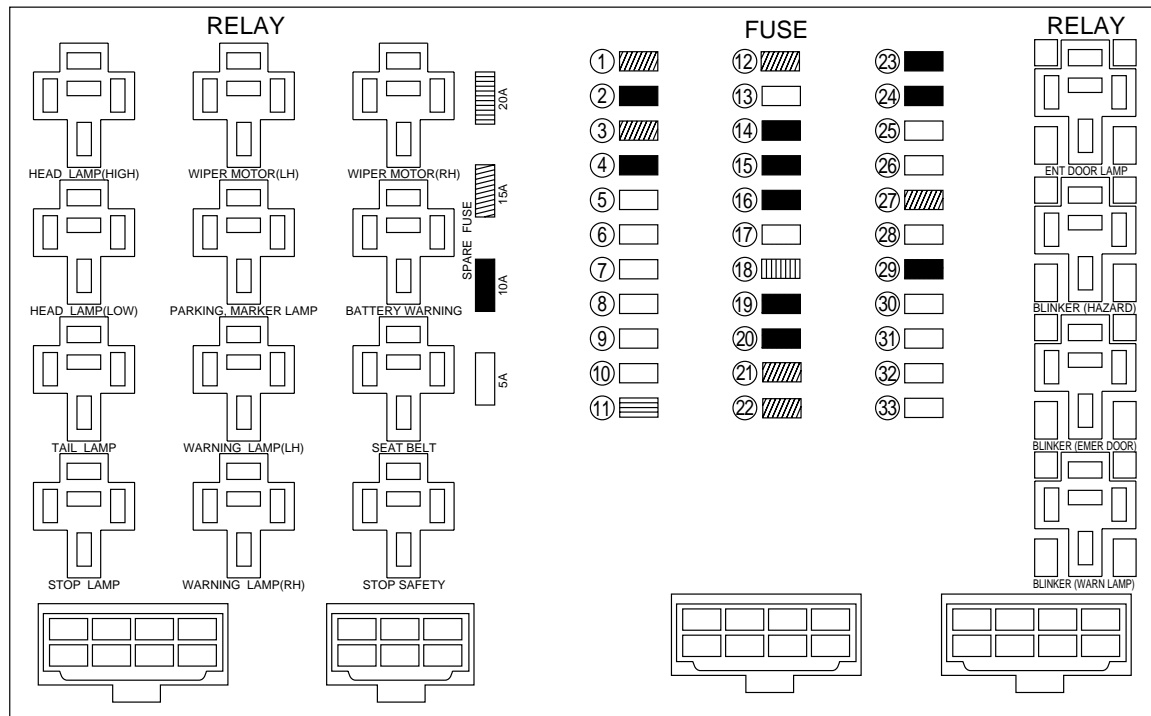

No.	Amp.	Fuse name	No.	Amp.	Fuse name	No.	Amp.	Fuse name
1	15A	Head lamp (HIGH)	12	15A	Starter sub relay	23	10A	Head lamp high (LH)
2	10A	Head lamp (LOW)	13	5A	Exhaust brake	24	10A	Head lamp high (RH)
3	15A	Tail lamp	14	10A	Regulator, Air dryer	25	5A	Head lamp low (LH)
4	10A	Stop lamp, Back up lamp	15	10A	Front LH wiper motor	26	5A	Head lamp low (RH)
5	5A	Room lamp FL 1	16	10A	Front RH wiper motor	27	15A	Tail lamp
6	5A	Room lamp FL 2	17	5A	Horn	28	5A	Battery main switch
7	5A	Room lamp BULB	18	20A	Electric fan	29	10A	Blinker unit (HAZARD)
8	5A	Driver lamp	19	10A	Spare	30	5A	Blinker unit (EMER. DOOR)
9	5A	Destination lamp	20	10A	Auto ventilator	31	5A	Parking lamp
10	5A	Meter power, Sensor power	21	15A	Stop arm, Warning lamp	32	5A	Warning buzzer
11	30A	Airconditioner	22	15A	Rear wiper motor & switch	33	5A	Radio

Type B

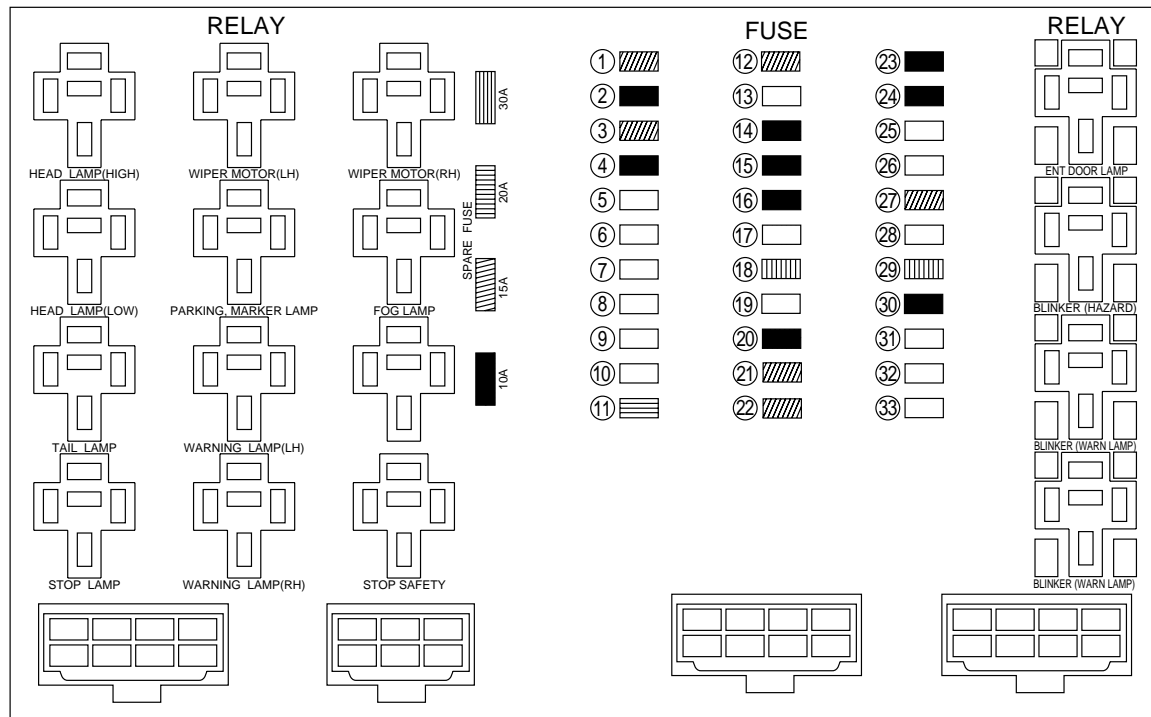

No.	Amp.	Fuse name	No.	Amp.	Fuse name	No.	Amp.	Fuse name
1	15A	Head lamp (HIGH)	12	15A	Starter sub relay	23	10A	Head lamp high (LH)
2	10A	Head lamp (LOW)	13	5A	Exhaust brake	24	10A	Head lamp high (RH)
3	15A	Tail lamp	14	10A	Regulator, Air dryer	25	5A	Head lamp low (LH)
4	10A	Stop lamp, Back up lamp	15	10A	Front LH wiper motor	26	5A	Head lamp low (RH)
5	5A	Room lamp FL 1	16	10A	Front RH wiper motor	27	15A	Tail lamp
6	5A	Room lamp FL 2	17	5A	Horn	28	5A	Defroster
7	5A	Room lamp BULB	18	20A	Electric fan	29	20A	Battery master fuse
8	5A	Driver lamp	19	5A	Warning buzzer	30	10A	Blinker unit (HAZARD)
9	5A	Destination lamp	20	10A	Auto ventilator	31	5A	Parking lamp
10	5A	Meter power, Sensor power	21	15A	Stop arm, Warning lamp	32	5A	Battery main switch
11	30A	Airconditioner	22	15A	Rear wiper motor & switch	33	5A	Radio

Type C

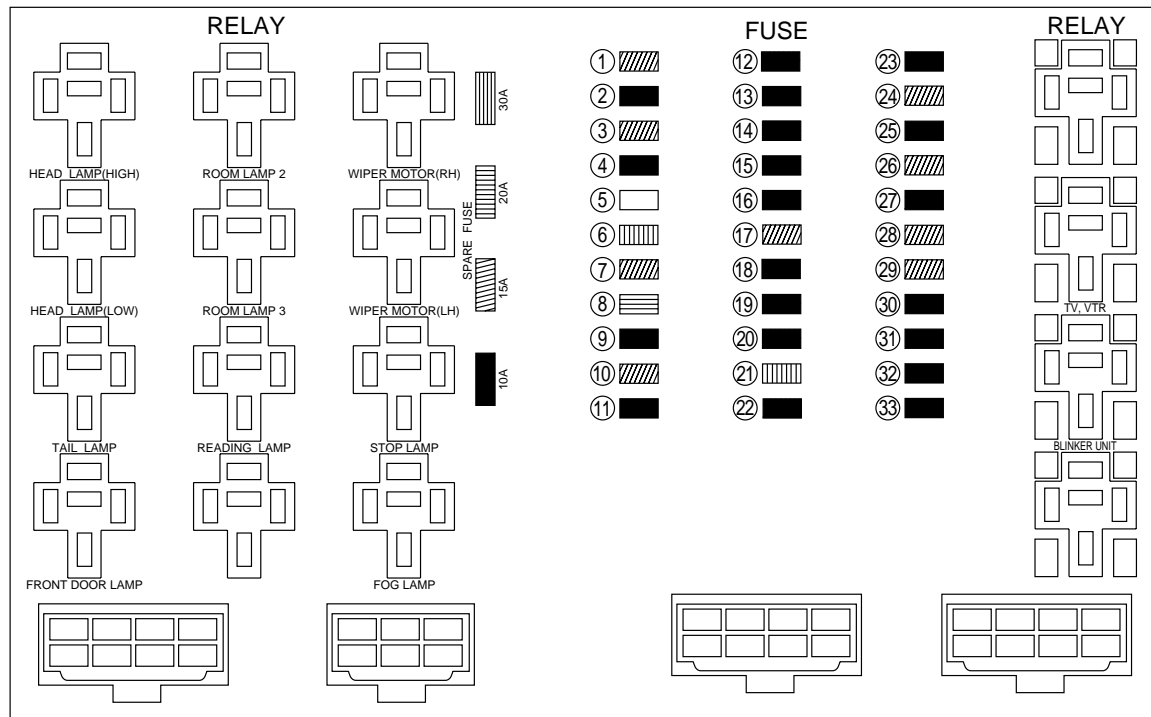

No.	Amp.	Fuse name	No.	Amp.	Fuse name	No.	Amp.	Fuse name
1	15A	Head lamp (HIGH)	12	10A	Room lamp 1	23	10A	Back up lamp
2	10A	Head lamp (LOW)	13	10A	Room lamp 2	24	15A	TV/VTR
3	15A	Tail lamp	14	10A	Room lamp 3	25	10A	Auto grease power
4	10A	Engine stop motor, Destination lamp	15	10A	Air dryer	26	15A	Starter key
5	5A	Stop lamp, Horn, Radio	16	10A	Luggage, Phone	27	10A	Interrupt switch
6	20A	A. B. S	17	15A	Defroster, Preheater	28	15A	Fog, Tail, Meter lamp
7	15A	Warning lamp(SPARE)	18	10A	Reading lamp	29	15A	Battery main power(1)
8	30A	Airconditioner	19	10A	Exhaust brake, Heater mirror	30	10A	Blinker unit, Park lamp
9	10A	Spare	20	10A	Regulator	31	10A	Door, Clock, Radio
10	15A	Wiper control relay	21	20A	Heater	32	10A	Spare
11	10A	Meter power, Buzzer, Door	22	10A	Auto ventilator	33	10A	Battery main switch

LUBRICATION

Lubrifications should be carefully selected according to the lubrication chart it is important to select viscosity of Lubricants according to the ambient temperature by referring to the following table.

VISCOSITY CHART

Engine oil

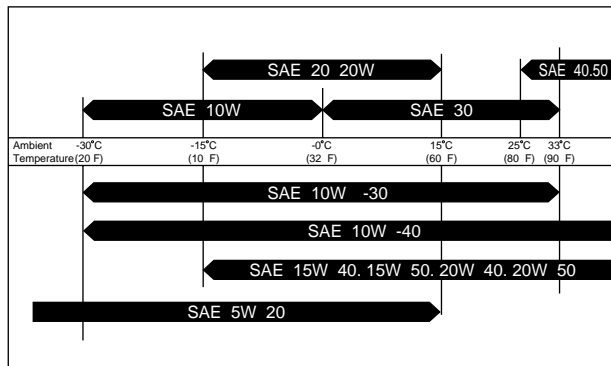

Gear oil

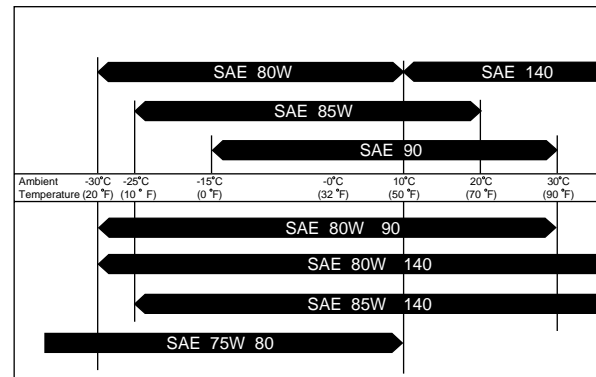

Lubrication list

Lubricant	Lubrication List	Capacity	Oil change period	Specification															
Engine oil	Engine	D1146 : 15.5 l (OIL PAN : 13 l)	Initial : 1,000km Inter city or long distance travel bus, every : 15,000km City bus, every : 10,000km	CF Grade (Frigid an area : 15W30 Except Frigid an area : 15W40)															
		DE12 : 20 l (OIL PAN : 17 l)																	
		DE08TiS : 19 l (OIL PAN : 15.5 l)	Initial : 1,000km Long distance : every 30,000km Short distance : every 20,000km	API CH-4 grade(SAE 15W40) or ACEA E2/E3 grade															
Engine coolant	Radiator	33(37)	Every : 1 year	Anti-freeze LLC Grade <table border="1" data-bbox="1435 890 1787 1098"> <thead> <tr> <th>AREA</th> <th>Mixing ratio(%)</th> <th>Freezing point(°C)</th> </tr> </thead> <tbody> <tr> <td>RUSSIA(Frigid)</td> <td>55(%)</td> <td>-48(°C)</td> </tr> <tr> <td>SOUTHEAST ASIA MIDDLE EAST AFRICA SOUTH AMERICA</td> <td>30(%)</td> <td>-12(°C)</td> </tr> <tr> <td>TAIWAN</td> <td>50(%)</td> <td>-38(°C)</td> </tr> <tr> <td>OTHERS</td> <td>30(%)~40(%)</td> <td>-16(°C)~-25(°C)</td> </tr> </tbody> </table> Inhibitor DCA65L (1% of engine coolant in volume)	AREA	Mixing ratio(%)	Freezing point(°C)	RUSSIA(Frigid)	55(%)	-48(°C)	SOUTHEAST ASIA MIDDLE EAST AFRICA SOUTH AMERICA	30(%)	-12(°C)	TAIWAN	50(%)	-38(°C)	OTHERS	30(%)~40(%)	-16(°C)~-25(°C)
AREA	Mixing ratio(%)	Freezing point(°C)																	
RUSSIA(Frigid)	55(%)	-48(°C)																	
SOUTHEAST ASIA MIDDLE EAST AFRICA SOUTH AMERICA	30(%)	-12(°C)																	
TAIWAN	50(%)	-38(°C)																	
OTHERS	30(%)~40(%)	-16(°C)~-25(°C)																	

Lubricant	Lubrication List	Capacity		Oil change period	Specification
Gear oil	Manual transmission	K805A/P	9.8 l	Initial : 5,000km Every : 20,000km	GL-4 Grade(80W/90)
		T8HS5B/P	10.0 l		
		K806P	11.2 l		
		T8HS6P	12.0 l		
	Auto transmission	MT643	25 l	On high way : every 1 year or 40,000km Off high way : every 1 year or 1,000h	DEXRON- II
Rear axle	11.5–12.5 l		Initial : 5,000km Every : 20,000km	GL-5(80W/90)	
Power steering	Power steering	5 l		Initial : 1,000km Every 24,000km	DEXRON R- II
Brake oil	Brake and clutch	4 l		Every : 1 year or 60,000km	DOT 3, DOT 4 Multipurpose EP No.2
Grease	Wheel bearings	Needed quantity		When hub repair	Multipurpose type grease
	Grease fittings			Manual : Every 4,000km	NLGI No.2 or 3
				Auto grease	KLGI No. 000.00

Moving parts(every 4,000km)

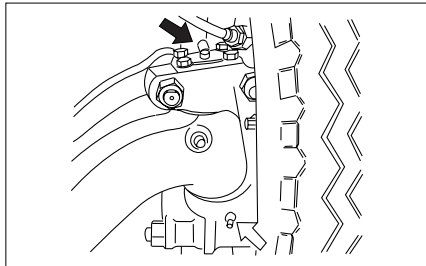

★ King pin (4 points)

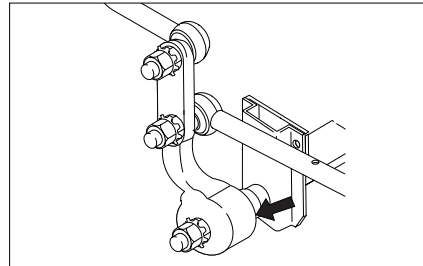

★ Link arm (1 point)

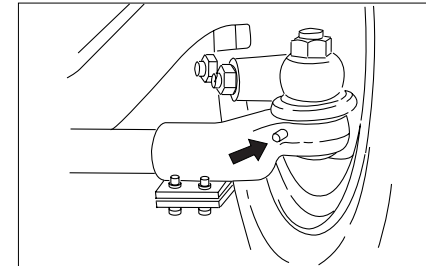

★ Tie rod end (2 points)

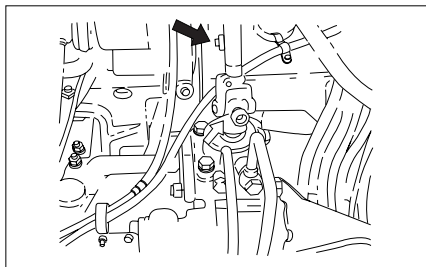

Steering shaft (1 point)

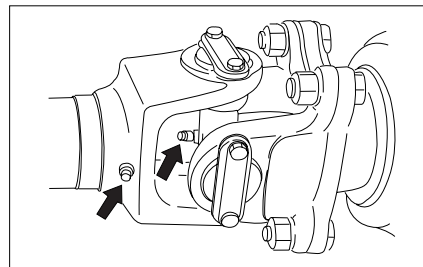

Propeller shaft (2 points)

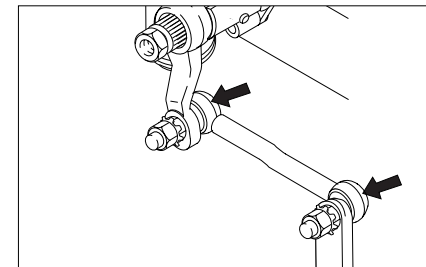

Drag link-FRT (2 points)

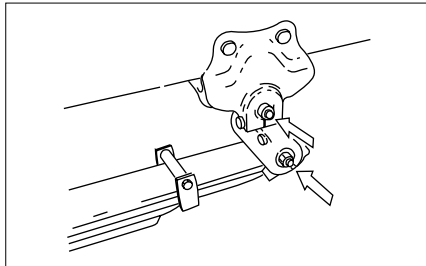

Spring and shackle pin(12 points)

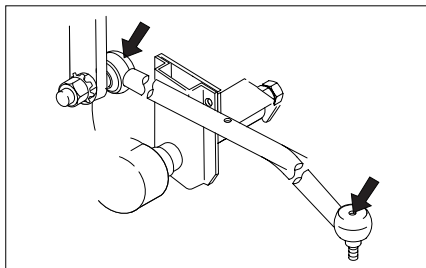

Drag link-RR (2 points)

SCHEDULED MAINTENANCE SERVICE

Maintenance of periodic inspection service and retention of records are owner's responsibility. The owner should retain records and carry out maintenance service in accordance with maintenance service chart.

Those are very important checking items which have to be checked for general vehicles. As this maintenance service chart is based on the vehicle which travels about 4,000km per month under normal driving condition, it is requested to reduce interval of the periodic inspection for vehicle which travels over 4,000km per month or under severe driving condition than normal. It is requested to check another items, if necessary even not mentioned this chart.

MAINTENANCE SERVICE CHART

INSPECTION POINTS	PERIOD : 1000 Km	0.5	4	8	12	16	20	24	28	32	36	40	44	48	D
ENGINE															
Check easiness of engine starting and abnormal noise			●	●	●	●	●	●	●	●	●	●	●	●	●
Check idling speed and acceleration			●	●	●	●	●	●	●	●	●	●	●	●	●
Check and clean air cleaner			●	●	●	●	●	●	●	●	●	●	●	●	
Change air cleaner element					◎			◎			◎			◎	
Adjust valve clearances	D1146 ENGINE	First 1,000km, second 2,500km, every 5,000km													
	DE08TiS/DE12 ENGINE	● (1,000km)					●						●		
Check fuel injection time, and fuel injection nozzle pressure					● (10,000km)	●	●			● (30,000km)	●			●	
Check compression pressure in each cylinder															(Every 60,000 km)
Check for oil contamination			●	●	●	●	●	●	●	●	●	●	●	●	○
Drain fuel filter and clean fuel strainer			●	●	●	●	●	●	●	●	●	●	●	●	
Washing fuel filter element (D1146 ENGINE)															(Primary filter : every 5,000km)
Change fuel filter element (D1146 ENGINE)															(Primary filter : every 15,000km, Secondary filter : every 5,000km)
Change fuel filter cartridge (EXCEPT D1146 ENGINE)							◎					◎			
Clean fuel tank inside								●						●	
Check exhaust gas and adjustment	●	●	●	●	●	●	●	●	●	●	●	●	●	●	●
Check function of air compressor and turbo-charger								●						●	
Check exhaust pipes for looseness (every 100,000km)		●	●	●	●	●	●	●	●	●	●	●	●	●	
Check fan belt for damage	●	●	●	●	●	●	●	●	●	●	●	●	●	●	●

* For engine oil and filter cartridge change Refer "periodic inspection and maintenance".

INSPECTION POINTS	PERIOD : 1000 Km	0.5	4	8	12	16	20	24	28	32	36	40	44	48	D
CLUTCH															
Check function of clutch system			●	●	●	●	●	●	●	●	●	●	●	●	●
Check clutch pedal free play and pedal stroke			●	●	●	●	●	●	●	●	●	●	●	●	●
Check minipack exhaust cover			●	●	●	●	●	●	●	●	●	●	●	●	
Change clutch oil		(Every 1 year or 60,000km)													
TRANSMISSION															
Check for oil leakage and oil fill up		●	●	●	●	●	●	●	●	●	●	●	●	●	●
Change oil	(1,000km)		●	(5,000km)			●						●		
Check for looseness in linkage														●	
PROPELLER SHAFT															
Check loose connections (every 5,000km)		●						●						●	
Check splines for excessive wear												●			
Check for looseness in bearing and related parts							●								
Grease the universal joints and spline		●	●	●	●	●	●	●	●	●	●	●	●	●	
FRONT AXLE & REAR AXLE															
Check front wheel bearing looseness					●			●			●			●	
Check rear wheel bearing looseness								●						●	
Check for looseness clamp bolt on axle shaft			●	●	●	●	●	●	●	●	●	●	●	●	●
Check for oil leakage in rear axle shaft and oil fill up		●	●	●	●	●	●	●	●	●	●	●	●	●	●
Change front and rear hub bearing grease	(1,000km)	(When take off and attachment)													
Change rear axle oil			●	(5,000km)			●						●		

INSPECTION POINTS	PERIOD : 1000 Km	0.5	4	8	12	16	20	24	28	32	36	40	44	48	D
SUSPENSION															
Retighten "U" bolt & nut		●												●	
Check spring for damage		●	●	●	●	●	●	●	●	●	●	●	●	●	●
Check mount for looseness and damage		●	●	●	●	●	●	●	●	●	●	●	●	●	●
Check shock absorber for leakage and damage					●			●			●			●	●
Check shock absorber mount					●			●			●			●	
Grease spring pin and shackle pin			●	●	●	●	●	●	●	●	●	●	●	●	
WHEELS															
Check for presence of foreign matters (nails, stones, etc.)			●	●	●	●	●	●	●	●	●	●	●	●	●
Retighten wheel nuts as necessary		●	●	●	●	●	●	●	●	●	●	●	●	●	●
Check wheel discs for damage			●	●	●	●	●	●	●	●	●	●	●	●	
STEERING															
Check for looseness in mount					●			●			●			●	
Check steering wheel free play		●	●	●	●	●	●	●	●	●	●	●	●	●	●
Check steering linkage for damage, looseness and excessive play		●			●			●			●			●	
Check for oil leakage in gear box			●	●	●	●	●	●	●	●	●	●	●	●	●
Check clearance between king pin & bearing														●	
Check wheel alignment														●	
Change power steering oil		● (1,000km)						●						●	

INSPECTION POINTS	PERIOD : 1000 Km	0.5	4	8	12	16	20	24	28	32	36	40	44	48	D
SERVICE BRAKE															
Check function of brake system and air dryer		●	●	●	●	●	●	●	●	●	●	●	●	●	●
Check brake pedal free play		●	●	●	●	●	●	●	●	●	●	●	●	●	●
Check for air leakage			●	●	●	●	●	●	●	●	●	●	●	●	●
Check linings for wear					●			●			●			●	●
Check brake drums for wear and damage														●	
Check hoses and pipes for leakage, damage				●	●	●	●	●	●	●	●	●	●	●	●
Change brake oil															(Every 1 year or 60,000km)
PARKING BRAKE															
Check function of parking brake			●	●	●	●	●	●	●	●	●	●	●	●	
ELECTRICAL EQUIPMENT															
Check charge state of battery					●			●			●			●	
Check function of starter					●			●			●			●	
Check function of generator & regulator					●			●			●			●	
Check generator brushes for wear														●	
Check starter brushes for wear														●	
Check terminals of wiring for damage			●	●	●	●	●	●	●	●	●	●	●	●	●

- * Refer to above-mention chart field "D" means daily inspection point (● : Daily check, ○ : Check for needs)
- * ● : Inspection mark
- : Change mark

TROUBLESHOOTING

ENGINE

Starter motor does not turn over or turning is slow.

CAUSE	REPAIR
<ul style="list-style-type: none">• Malfunction of contact point of battery relay.• Run down battery• Loosened, corroded or disconnected battery terminal • Ground cable cut• Too thick oil viscosity	<ul style="list-style-type: none">• Turn "ON" battery main switch• Battery charging or change• Remove the corroded part of battery terminal with chisel, retighten connector and apply grease.• Be sure to connect the wiring• Change oil with proper viscosity

Start motor turns over but engine won't start

CAUSE	REPAIR
<ul style="list-style-type: none">• Empty fuel tank• None sufficient preheating• Air mixed in fuel• Clogged fuel filter	<ul style="list-style-type: none">• Refill or replenish• Preheat exactly and sufficiently• Bleed air in fuel• Clean filter element or change

Engine stops at low speed

CAUSE	REPAIR
<ul style="list-style-type: none">• Too low idle rpm• Air cleaner element contamination• Over cooled engine• Clogged fuel filter• Valve clearance deviated	<ul style="list-style-type: none">• Adjust idle rpm with knob.• Clean element or change• Cover radiator with curtain• Clean filter element or change• Adjust valve clearance

Engine lacks power

CAUSE	REPAIR
<ul style="list-style-type: none">• Parking brake not released• Air cleaner element contamination• Brake detention• Incorrect valve clearance• Clutch slip• Clogged fuel filter• Clogged fuel strainer• Wear out of position ring	<ul style="list-style-type: none">• Fully release parking brake• Clean element or change• Adjust the clearance of brake lining• Adjust valve clearance• Adjust the clearances or change clutch disc.• Clean or change• Clean or change• Check cylinder pressure and repair

Engine overheat

CAUSE	REPAIR
<ul style="list-style-type: none">• Radiator curtain covered or Radiator contamination• Lack of coolant • Fan belt loosened• Rust or scale in coolant• Malfunction of thermostat	<ul style="list-style-type: none">• Uncover radiator curtain or clean radiator• Replenish coolant, check leakage and radiator cap tightly closed.* Don't open radiator cap when coolant is hot.• Adjust fan belt tension or change fan belt if damaged.• Change coolant or clean in side of the radiator• Change thermostat

Black smoke

CAUSE	REPAIR
<ul style="list-style-type: none">• Air cleaner contamination• Incorrect valve clearance	<ul style="list-style-type: none">• Clean air cleaner element or change• Adjust valve clearance

Excessive fuel consumption

CAUSE	REPAIR
<ul style="list-style-type: none">• Fuel leakage• Air cleaner contamination• Engine overcooling• Lack of tire inflation• Brake detent• Clutch slip	<ul style="list-style-type: none">• Check fuel line and repair• Clean air cleaner element or change• Cover radiator with curtain• Inflate tire to specified value.• Adjust the clearance of brake lining• Adjust the clearance or change clutch disc.

Lack of engine oil pressure

CAUSE	REPAIR
<ul style="list-style-type: none">• Lack of engine oil• Oil leakage• Improper oil viscosity	<ul style="list-style-type: none">• Replenish to specified level• Check lubrication line and retighten loosened fitting• Change oil with proper viscosity

Excessive engine oil consumption

CAUSE	REPAIR
<ul style="list-style-type: none">• Improper oil specification• Excessive oil amount• Oil leakage• Delayed oil changing period• Neglected engine warming• Piston ring wear out	<ul style="list-style-type: none">• Change oil with proper specification• Change oil level to specified value.• Check lubrication line and retighten loosened fitting• Change oil periodically• Warm up engine to specified temperature• Check cylinder pressure and repair

POWER TRAIN

Abnormal noise in transmission or rear axle in operation

CAUSE	REPAIR
<ul style="list-style-type: none">• Lack of gear oil• Improper oil viscosity	<ul style="list-style-type: none">• Replenish to specified level• Change oil with proper specification

Abnormal vibration in operation

CAUSE	REPAIR
<ul style="list-style-type: none">• Loosened bolts and nuts of propeller shaft and peripheral parts.• Unbalanced propeller shaft	<ul style="list-style-type: none">• Check and retighten• Modify propeller shaft or change

STEERING

Hard steering

CAUSE	REPAIR
<ul style="list-style-type: none">• Lack of front tire inflation• Lack of oil of power steering	<ul style="list-style-type: none">• Charge air to specified pressure• Replenish or discharge

Non return to straight position

CAUSE	REPAIR
<ul style="list-style-type: none">• Lack of grease in parts of steering system• Interference between drag link joint and peripheral parts	<ul style="list-style-type: none">• Insert grease• Check and correct

Steering wheel shimmy

CAUSE	REPAIR
<ul style="list-style-type: none">• Loosend hub nut• Different tire inflation of "RH" and "LH"• Irregular tire wear• Excessive handle clearance• Worn out drag link coil spring• Worn out knuckle shim	<ul style="list-style-type: none">• Replenish to specified level• Charge air to be same• Change• Adjust steering wheel clearance• Change to new one• Change shim or adjust

BRAKE**Poor brake action**

CAUSE	REPAIR
<ul style="list-style-type: none">• Excessive tire inflation• Leakage of brake line• Excessive lining clearance• Excessive tire wear	<ul style="list-style-type: none">• Charge to specified pressure• Check the connection and correct• Adjust the clearance and change lining• Change to new tire

Side braking

CAUSE	REPAIR
<ul style="list-style-type: none">• Different tire inflation of "RH" and "LH"• Side wear of tire• Different lining clearances of "RH" and "LH" wheel	<ul style="list-style-type: none">• Charge to be same pressure• Change• Adjust clearances correctly

Detent braking

CAUSE	REPAIR
<ul style="list-style-type: none">• Improper lining clearance	<ul style="list-style-type: none">• Adjust clearance properly

SUSPENSION

Different vehicle height

CAUSE	REPAIR
<ul style="list-style-type: none">• Damaged or mislocated spring• Tire inflation or puncture	<ul style="list-style-type: none">• Check the spring and repair• Check tire and correct

Meandered advancing

CAUSE	REPAIR
<ul style="list-style-type: none">• Radius rod cut• Improper location axle	<ul style="list-style-type: none">• Change radius rod• Adjust the location

ELECTRICAL

Excessive battery discharging

CAUSE	REPAIR
<ul style="list-style-type: none">• Battery terminal disconnected, loosened, corroded.• Aged battery• V-belt slip or cut• Keeping lamp lights "ON"• Improper alternator charging	<ul style="list-style-type: none">• Remove corroded part of battery terminal with chiesel, retighten connector and apply grease.• Change• Check belt tension, adjust or change• Be sure to turn "OFF" switch• Check alternator charging condition and repair.

LAMP DOESN'T LIGHT "ON"

CAUSE	REPAIR
<ul style="list-style-type: none">• Lamp faulty• Fuse cut • Non-complete ground	<ul style="list-style-type: none">• Change lamp• Change to specified fuse (Even after changing to new fuse, fuse cut again, precise inspection is necessary and be sure not to use deviated fuse.• Be sure to ground completely

SMOKE

Cause and repair of smoke

DESCRIPTION	CAUSE	REPAIR
Excessive fuel injection	• Low idle RPM	Adjust idle RPM
	• Maximum speed increase	Adjust maximum speed
	• Plunger worn out	Change plunger
	• Delivery valve worn out, damaged	Change delivery valve
	• Deviated flow rate	Adjust flow rate
Poor nozzle injection	• Blocked nozzle tip	Change nozzle tip and holder
	• Enlarged nozzle tip injection hole	Change nozzle tip
	• Injection pressure down	Adjust injection pressure
Compression pressure down	• Piston ring worn out, cut	Change piston ring
	• Cylinder liner worn out, damage	Change cylinder liner
	• Piston worn out, damaged	Change piston
	• Poor contact of valve and valve seat	Change valve
	• Head gasket damaged, poor sealing	Change head gasket
	• Poor nozzle assembly	Reassemble nozzle or change
Incorrect timing of injection pump	• Incorrect injection timing	Adjust injection timing
	• Incorrect timer angle adjustment	Adjust timer angle

DESCRIPTION	CAUSE	REPAIR
Lack of intake air	• Air cleaner element contamination	Clean air cleaner or change
	• Lack of capacity of air cleaner	Change to genuine part
	• Incorrect intake valve clearance	Adjust valve clearance
	• Intake ducts blocked or deformed	Change intake ducts
	• Leakage of turbo charged air	Check and repair leaking parts
	• Malfunction of turbo charger	Change turbo charger
Excessive exhaust Pressure	• Exhaust gas manifold blocked	Change exhaust manifold
	• Incorrect exhaust valve clearance	Check or change
Overload operation	• Overloaded	Unload to specified value
	• Excessive engine oil	Extract oil to specified level
	• Piston stuck by overheat	Change piston, piston ring and related parts.
	• Metal bearing burnt	Change metal bearing
Poor quality of fuel	• Fuel quality poor	Use specified fuel
	• Water mixed fuel	Clean fuel tank and remove water
	• Fuel filter contamination	Clean fuel filter or change

MAIN DATA AND SPECIFICATION

1. ENGINE

1-1. D1146, DE12 ENGINE

Distinction		D1146	DE12
Type		water cooled 4 cycle in-line, overhead valve type	
Cylinder liner type		dry type	
No. of piston ring		compression ring ; 2ea, oil ring : 1ea	
No. of cylinder		6	←
Bore × stroke(mm)		111×139	123×155
Piston displacement(cc)		8071	11051
Compression ratio		18.0 : 1	17.1 : 1
Engine dimensions(mm)	length	1253	1317
	width	811.5	744
	height	934.5	1015
Engine weight(dry) (kg)		730	872
Idle speed		600±50	←
Fuel injection timing		BTDC 15	BTDC 10
Fuel injection order		1-5-3-6-2-4	
Intake valves	open at	BTDC 16	BTDC 18
	close at	ABDC 36	ABDC 34
Exhaust valves	open at	BBDC 46	←
	close at	ATDC 14	←

Distinction	D1146	DE12
Oil pump type	gear type	
Oil cooler type	water cooled, integral type	
Oil capacity(liters)	ENG.TOT : 15.5 l , OIL PAN : 13 l	ENG.TOT : 20 l , OIL PAN : 17 l
Cooling method	fresh water forced circulation	
Cooling water capacity(liters)	11	19
Water pump type	centrifugal type	
Thermostat type	wax-pellet type	
Max. output(kW(ps)/rpm)	130(182)/2500	169(230)/2200
Max. torque(N·m(kg·m)/rpm)	563(57)/1600	799(81)/1300
Starter motor output(V × kW)	24×4.5	24×5.4
Engine location	rear	←
Battery capacity(V × AH)	24×150	←

1-2. DE08TiS ENGINE

Distinction		DE08TiS(225ps)	DE08TiS(240ps)
Type		water cooled 4 cycle in-line, overhead valve type	
Cylinder liner type		dry type	
No. of piston ring		compression ring : 2ea, oil ring : 1ea	
No. of cylinder		6	←
Bore × stroke(mm)		111×139	←
Piston displacement(cc)		8071	←
Compression ratio		18.5 : 1	←
Engine dimensions(mm)	length	1169	←
	width	812	←
	height	1003	←
Engine weight(dry) (kg)		745	←
Idle speed (rpm)		600~650	←
Fuel injection timing		BTDC 3	←
Fuel injection order		1-5-3-6-2-4	
Intake valves	open at	BTDC 16	←
	close at	ABDC 36	←
Exhaust valves	open at	BBDC 46	←
	close at	ATDC 14	←

Distinction	DE08TiS(225ps)	DE08TiS(240ps)
Oil pump type	gear type	
Oil cooler type	water cooled, integral type	
Oil capacity(liters)	ENG.TOT : 19/, OIL PAN : 15.5/	
Cooling method	fresh water forced circulation	
Cooling water capacity(liters)	11	←
Water pump type	centrifugal type	
Thermostat type	wax-pellet type	
Max. output(ps/rpm)	225/2300	240/2300
Max. torque(kg.m/rpm)	82/1000	90/1000
Starter motor output(V × kW)	24×4.5	←
Engine location	Rear	←
Battery capacity(V × AH)	24×150	←

2. CLUTCH

Distinction		BF106			
		D1146	DE08TiS(225ps)	DE12	DE08TiS(240ps)
Type		dry single plate with coil spring dampers hydraulic circuit incorporating clutch minipack			
Clutch facing dimensions(mm)	outside dia	380	←	430	←
	inside dia	240	←	250	←
	thickness	5	←	←	←
Clutch clamping force(kg)		1240 ±10%	1470 ±10%	1380 ±10%	←
Clutch pedal	ratio	7.09			
	free play	48.8			
	max. stroke	170			
Clutch minipack start working pressure(kg/cm ²)		5.5			
Master cylinder bore dia.(mm)		20			

3. TRANSMISSION

3-1. Manual transmission

MODEL	K805A	K805P	K806P	T8HS5B	T8HS5P	T8HS6P	
SPEED	5.D.D	5.O.D	6.O.D	5.D.D	5.O.D	6.O.D	
TORQUE(kgm)	82	82	82	82	82	82	
GEAR RATIO	1ST	6.666	5.455	6.666	6.571	5.405	6.571
	2ND	3.826	3.130	3.826	3.807	3.447	3.807
	3RD	2.213	1.728	2.213	2.201	1.739	2.201
	4TH	1.417	1.000	1.417	1.463	1.000	1.463
	5TH	1.000	0.745	1.000	1.000	0.738	1.000
	6TH	-	-	0.734	-	-	0.751
	REV	6.851	5.606	6.851	6.240	5.650	6.240
DRY WEIGHT(kg)	192	192	200	234	234	279	
OIL CAPACITY(l)	9.8	9.8	11.2	10.0	10.0	12.0	

3-2. Auto transmission

MODEL	MT643	
SPEED	4.D.D	
TORQUE(kgm)	88.4	
GEAR RATIO	1ST	3.58
	2ND	2.09
	3RD	1.39
	4TH	1.00
	5TH	-
	6TH	-
	REV	5.67
DRY WEIGHT(kg)	231	
OIL CAPACITY(l)	25	

4. PROPELLER SHAFT

Distinction		BF106				
		D1146		D1146		DE12
		K805A/P. T8HS5B/P	K806P	T8HS6P	K806P	T8HS6P
1st piece(mm) (when equipped)	length	1586	1494.2	1485.2	1535.8	1526.8
	outside dia.	88.9	←	←	←	←
	inside dia.	80.9	←	←	←	←
2nd piece(mm) (when equipped)	length	1467.5	←	←	1334.1	←
	outside dia.	88.9	←	←	←	←
	inside dia.	80.9	←	←	←	←
3rd piece(mm) (when equipped)	length	1360	←	←	1350	←
	outside dia.	88.9	←	←	←	←
	inside dia.	80.9	←	←	←	←

5. FRT AXLE

		BF106
Type		Reverse Elliot I Beam
Tire. Tread(mm)		2050
Capacity(kg)		6000
King pin(mm)	outside dia.	50
	length	252
Wheel alignment	toe - in(mm)	4~6
	camber(°)	0.5° ± 30'
	caster(°)	-1°00' ± 30'
	kingpin inclination(°)	7.5° ± 10'
Steering angle	inside(°)	42°
	outside(°)	34°

6. REAR AXLE

		BF106
Type		Banjo full floating type
Final drive gear type		Spiral bevel
Final gear ratio	OPTION	39/6
		39/7
		39/8
Oil capacity (liters)		11.5~12.5 l
Axle load capacity (kg)		9500

7. STEERING

Distinction		BF106
Type		Recirculating ball with intergral power assisted
Steering wheel diameter(mm)		500
Power steering	gear ratio	22.4 : 1
	sector gear operating angle	96°
	gear oil capacity(l)	1
Length of drop arm(mm)		200
Oil capacity(liters)		5

8. BRAKES

8-1. Air over hydraulic dual circuit brake

Distinction		BF106	
Drum inside Diameter(mm)	front	410	
	rear	410	
Brake lining(mm) L×W×T - N	front	209×155×16 - 8	
	rear	209×180×16 - 8	
Wheel cylinder bore dia.(mm)	front	53.5	
	rear	55.56	
Anchor pin(mm) dia. ×length	front	30×133.5	
	rear	35×132	
Parking brake	Type	Internal expansion drum type	
		K805A/P, K806P	T8HS5B/P, T8HS6P
	Brake drum inside dia.(mm)	254	304.8
	Brake lining(mm) L×W×T	288×60×5.5	353×75×6.15
Auxiliary brake	Exhaust brake	←	

8-2. Full air dual circuit brake (OPTION)

Distinction		BF106
Drum inside Diameter(mm)	front	410
	rear	410
Brake lining(mm) L × W × T - N	front	209 × 155 × 19 - 8
	rear	209 × 220 × 19 - 8
Wheel cylinder bore dia.(mm)	front	-
	rear	-
Anchor pin(mm) dia. × lengh	front	30 × 106.5
	rear	30 × 121.5

9. SUSPENSION

Leaf spring

	Distinction		BF106
Leaf Spring	type		Semi elliptical alloy steel
	FRT	span(mm)	1400
		width(mm)	80
		thickness(mm)	11-2
		- no.of leaf	12-7
			11-1
		spring constant(kg/mm)	32.83
	RR	span(mm)	1660
		width(mm)	100
		thickness(mm)	12-2
- no.of leaf		11-3	
		16-4	
	spring constant(kg/mm)	32.86	
Shock Absorber	type		Hydraulic, double acting telescopic
	damp force (kg)	FRT rebound	650
		FRT compression	275
		RR rebound	650
		RR compression	260

10. WHEEL AND TIRES

Distinction		9.00-20-14PR (Tube)	9.00R20-14PR (Tube, radial)	10.00-20-14PR (Tube)	10.00-20-16PR (Tube)	10.00R-20-16PR (Tube, radial)	11.00-20-16PR (Tube)	11.00R20-16PR (Tube, radial)
Tire	OUT.Dia.(mm)	1014~1034	1006~1032	1046~1076	←	←	1078~1108	1068~1098
	MAX.width(mm)	229	←	254	←	←	295	293
	Tire inflation pressure							
	front	7.7kg/cm ² (109psi)	8.0kg/cm ² (113psi)	7.0kg/cm ² (99psi)	8.1kg/cm ² (115psi)	←	8.4kg/cm ² (119psi)	←
	rear	7.0kg/cm ² (99psi)	7.3kg/cm ² (103psi)	6.3kg/cm ² (89psi)	7.4kg/cm ² (105psi)	←	7.7kg/cm ² (109psi)	←
Disc wheel size		7.00T-20	←	←	←	←	7.50V-20	←

11. COOLER

Sub cooler

Type		PBC - 2400(D)	
Cooling capacity(kcal/h)		26000	
Refrigerant		R-12/R-134a (OPTION)	
Weight		about 550kg	
Engine	model		KIA S-2
	piston displacement(cc)		2209
	no. of cylinder		4
	rotating speed(rpm)	high	1850
		mid	1450
low		1150	
Compressor	type		ND 6C - 500
	piston displacement(cc/rev)		495
Condenser		AL FIN & CU TUBE	
Blower capacity(m ³ /min) (AT 40mm Aq)		66.7	
Expansion valve		thermostatic expansion valve	
Receiver capacity(liters)		2.6	

BODY DIMENSION

FRONT ENTRANCE DOOR(OPT : MID ENT DOOR, DRIVER DOOR, EMERGENCY DOOR)

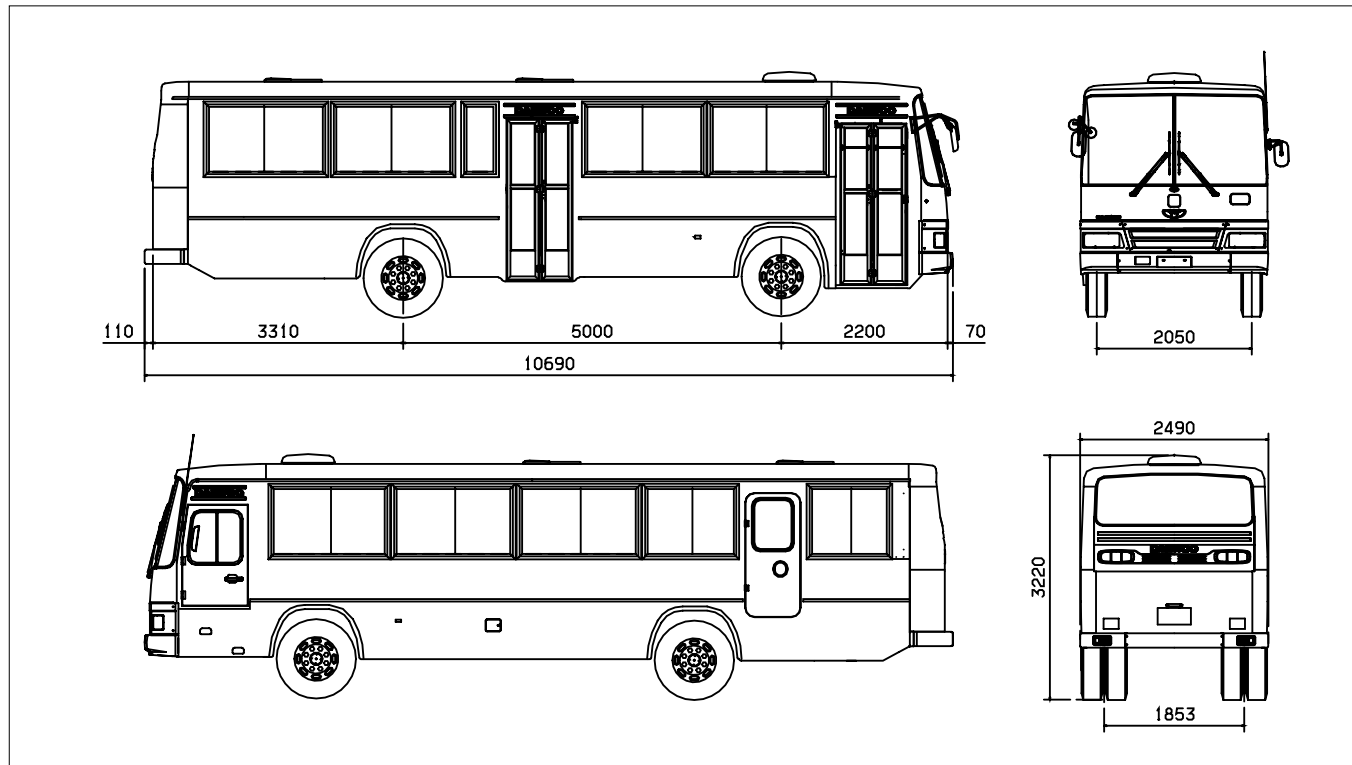

BF106
OWNER'S MANUAL

BUS TECHNICAL CENTER
DAEWOO MOTOR CO., LTD

188-9 JEON PO-DONG, JIN-KU,
BUSAN, KOREA

OM-BF-C2-03C-0205
