

Mandalay

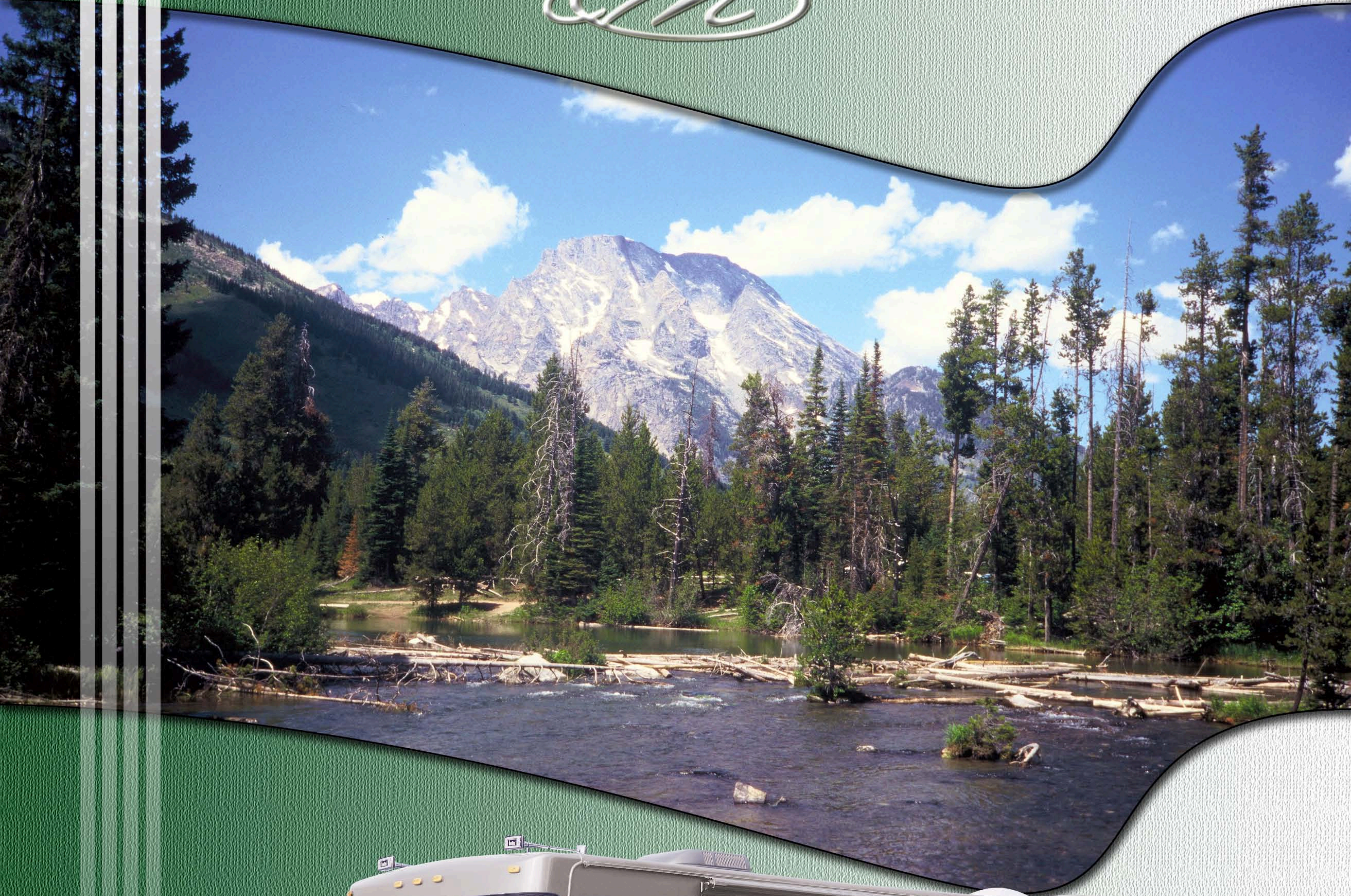

Owner's Manual
07/2003

TABLE OF CONTENTS

| | |
|---|-----|
| <u>LIMITED WARRANTY</u> | 1-1 |
| WHAT IS COVERED | 1-1 |
| HOW TO GET SERVICE | 1-1 |
| WHAT IS NOT COVERED | 1-2 |
| LIMITATIONS AND DISCLAIMER OF IMPLIED WARRANTIES | 1-3 |
| LEGAL REMEDIES AND ARBITRATION | 1-3 |
| | |
| <u>CUSTOMER CARE ROADSIDE ASSISTANCE PLAN</u> | 1-4 |
| EMERGENCY ROADSIDE ASSISTANCE | 1-4 |
| 24-HOUR TOLL FREE EMERGENCY MESSAGE SERVICE. | 1-4 |
| FREE CUSTOMER TRIP ROUTING AND FULL COLOR MAP SERVICE | 1-4 |
| TOLL FREE NATIONWIDE SERVICE APPOINTMENT SERVICE | 1-5 |
| SERVICE ASSISTANCE | 1-5 |
| | |
| <u>SERVICE NUMBERS FOR OWNER'S REFERENCE</u> | 1-6 |
| | |
| <u>OWNER'S PERSONAL PROPERTY RECORD</u> | 1-7 |
| | |
| <u>OWNER'S INSURANCE INFORMATION</u> | 1-8 |
| | |
| <u>INTRODUCTION</u> | 2-1 |
| | |
| <u>TRAVEL PREPARATION</u> | 3-1 |
| CHASSIS CHECKS | 3-1 |
| RV SYSTEM CHECK | 3-2 |
| TANK CAPACITIES | 3-2 |
| FIRST SHORT TRIPS. | 3-3 |

CARE & MAINTENANCE **4-1**

| | |
|---|-----|
| GENERAL INFORMATION | 4-1 |
| FIBERGLASS SIDEWALLS | 4-1 |
| SEALS & ADHESIVES | 4-2 |
| EXTRUSIONS & ALUMINUM SURFACES | 4-3 |
| WINDOWS & DOORS. | 4-3 |
| FRAME | 4-3 |
| TIRES | 4-3 |
| ROOF | 4-4 |
| TV ANTENNA | 4-4 |
| EXTERIOR LIGHTS. | 4-5 |
| APPLIANCES, SINKS & COUNTERTOPS | 4-5 |
| PRE-FINISHED PANELS AND WOOD SURFACES | 4-5 |
| WATER SYSTEM. | 4-5 |
| ELECTRICAL SYSTEM. | 4-6 |
| ROOF VENTS. | 4-6 |
| ABS PLASTICS | 4-6 |
| WINTER PRECAUTIONS. | 4-7 |
| STORAGE PREPARATIONS | 4-8 |

PERIODIC MAINTENANCE CHART **4-9**

IDENTIFICATION & SAFETY **5-1**

| | |
|---|-----|
| REPORTING SAFETY DEFECTS | 5-1 |
| RECREATIONAL VEHICLE SERIAL NUMBER DECALS & DATA PLATES | 5-1 |
| MANUFACTURER'S WARRANTIES | 5-2 |
| SAFETY REGULATIONS FOR LP GAS SYSTEMS & APPLIANCES. | 5-3 |
| FIRE SAFETY. | 5-4 |
| FIRE EXTINGUISHER | 5-5 |
| CARBON MONOXIDE DETECTOR. | 5-6 |
| CARBON MONOXIDE SAFETY PRECAUTIONS. | 5-7 |
| SMOKE DETECTOR | 5-7 |
| SEAT BELTS | 5-8 |
| EGRESS EXIT WINDOW | 5-9 |

AUTOMOTIVE OPERATIONS & PROCEDURES

6-1

| | |
|---|------|
| GENERAL INFORMATION | 6-1 |
| NEW VEHICLE BREAK IN | 6-1 |
| BRAKES. | 6-1 |
| WHEEL & TIRES | 6-1 |
| DAMAGED OR FLAT TIRES | 6-2 |
| WHEEL NUT TORQUES | 6-2 |
| WHEEL & TIRE BALANCING | 6-2 |
| FRONT SUSPENSION & ALIGNMENT | 6-3 |
| POWER PLANT & DRIVE TRAIN | 6-3 |
| ENGINE COOLING SYSTEM | 6-3 |
| PROPER LOADING & WEIGHT DISTRIBUTION | 6-4 |
| WEIGHT INFORMATION LABEL | 6-5 |
| COMPUTING YOUR LOAD & LOAD DISTRIBUTION | 6-6 |
| DRIVING | 6-7 |
| HILLS, DALES & MAKING THE GRADE | 6-7 |
| TRAILER TOWING | 6-8 |
| TOWING PROCEDURE. | 6-9 |
| EMERGENCY STOPPING. | 6-10 |
| FUELING YOUR MOTORHOME | 6-10 |

CHASSIS FUNCTIONS

7-1

| | |
|--|-----|
| DASH CONTROLS | 7-1 |
| DASH HEATER/AIR CONDITIONER | 7-2 |
| FAN SWITCH | 7-4 |
| ACCESSORY SWITCH | 7-4 |
| EMERGENCY START | 7-4 |
| HEADLIGHT SWITCHES | 7-4 |
| WIPERS. | 7-4 |
| GENERATOR REMOTE SWITCH & HOUR METER | 7-5 |
| CIGARETTE LIGHTER | 7-5 |
| HEATED MIRROR SWITCH | 7-5 |
| POWER MIRROR ADJUSTMENT | 7-5 |

EXTERIOR OPERATIONS **8-1**

| | |
|------------------------------------|-----|
| ENTRY DOOR | 8-1 |
| POWER STEP | 8-2 |
| STORAGE. | 8-2 |
| LADDER & ROOFTOP STORAGE | 8-3 |
| AWNINGS. | 8-3 |
| GENERATOR SLIDE | 8-3 |
| GENERATOR SAFETY | 8-4 |
| RALLY KIT COMPARTMENT | 8-5 |

WATER AND DRAINAGE **9-1**

| | |
|---|-----|
| GENERAL INFORMATION | 9-1 |
| FRESH WATER SYSTEM. | 9-1 |
| EXTERNAL HOOKUP. | 9-1 |
| FRESH WATER TANK | 9-1 |
| WATER PUMP | 9-2 |
| SANITIZING THE FRESH WATER SYSTEM | 9-2 |
| MONITOR PANEL. | 9-3 |
| COMMON FIELD PROBLEMS | 9-4 |
| WASTE WATER SYSTEM | 9-4 |
| HOLDING TANKS. | 9-5 |
| FAUCETS | 9-6 |
| TOILET | 9-7 |
| WATER SYSTEM WINTERIZATION | 9-7 |
| WATER SYSTEM, MAINTENANCE & TROUBLESHOOTING | 9-8 |

ELECTRICAL SYSTEM **10-1**

| | |
|---|------|
| GENERAL INFORMATION | 10-1 |
| CONNECTING TO AN OUTSIDE POWER SOURCE | 10-1 |
| CIRCUIT BREAKERS | 10-2 |
| GROUND FAULT CIRCUIT INTERRUPTER | 10-2 |
| POWER INVERTER | 10-3 |
| BATTERY ISOLATOR CONTROLLER | 10-3 |
| BATTERY DISCONNECT SWITCHES | 10-4 |
| BATTERY CHARGING | 10-4 |
| BATTERY MAINTENANCE | 10-5 |
| BATTERY SAFETY | 10-6 |
| 12 VOLT FUSES. | 10-6 |
| AUTOMOTIVE 12 VOLT SYSTEM. | 10-7 |

LP GAS SYSTEM **11-1**

GENERAL INFORMATION 11-1
FILLING THE LP GAS TANK 11-2
LP GAS REGULATOR. 11-3
REGULATOR FREEZE-UP 11-4
OTHER COLD WEATHER FACTORS. 11-4
HOSES, PIPES, TUBES AND FITTINGS 11-5
CHECKING THE LP GAS SYSTEM FOR LEAKS 11-6
ABOUT YOUR LP GAS DETECTOR 11-6
LP GAS SAFETY PRECAUTIONS. 11-8

INTERIOR CONTROLS & OPERATIONS **12-1**

REAR VISION TV MONITOR SYSTEM 12-1
LIVING QUARTERS 12-1
CONDENSATION 12-2
OVERHEAD VENTS. 12-2
HYDRAULIC POWER LEVELERS. 12-3
SLIDE-OUT 12-4
ROOM EXTENSION PROCEDURE 12-4
ROOM RETRACTION PROCEDURE 12-5
MANUAL ROOM RETRACTION PROCEDURE 12-6
WINDOWS. 12-6
DOORS, DRAWERS, AND STORAGE COMPARTMENTS 12-7
SEATING, TABLES AND ADDITIONAL BEDS 12-8

MANDALAY LIMITED WARRANTY



WHAT IS COVERED

The Mandalay, by Four Winds International Corporation (hereafter "Mandalay"), warranty covers this recreational vehicle (hereafter "RV"), when used only for recreational travel and camping, for three (3) years, or the first thirty six thousand (36,000) miles of use. In addition, this limited warranty covers the steel or aluminum frame structure of the floor, sidewalls, roof and rear and front walls for five (5) years or the first sixty thousand (60,000) miles of use. The warranty period begins on the date that the RV is delivered to the first retail purchaser by an independent, authorized dealer of Mandalay. In the event that a substantial defect in material or workmanship, attributable to Mandalay, is found to exist during the warranty period, Mandalay will repair or replace the defective material or workmanship, at its option, at no charge to the RV owner, in accordance with the terms, conditions and limitations of this limited warranty.

This limited warranty applies to all owners, including subsequent owners, of the RV. However, all rights and limitations within this warranty are applicable to all owners, including subsequent owners of the RV, and all subsequent owners must complete the Warranty Transfer Form contained in the Owner's Manual and send it to Mandalay. Any subsequent owner's warranty coverage period is the remaining balance of the warranty coverage period that the prior owner was entitled to under this limited warranty.

Mandalay's obligation to repair or replace defective materials or workmanship is the sole obligation of Mandalay under this limited warranty. Mandalay reserves the right to use new or remanufactured parts of similar quality to complete any work. Mandalay makes no warranty as to the future performance of this RV, and this limited warranty is not intended to extend to the future performance of this RV, or any of its materials, components or parts. In addition, the RV owner's obligation to notify Mandalay, or one of its authorized, independent dealers, of a claimed defect does not modify any obligation placed on the RV owner to contact Mandalay directly when attempting to pursue remedies under state or federal law.

HOW TO GET SERVICE

To obtain warranty service the owner must do all of the following:

- 1) Complete and return the Owner Registration Card within ten (10) days of purchase;
- 2) Notify Mandalay, or one of its authorized, independent dealers, in writing, of any claimed defect within the warranty coverage period;
- 3) Provide the notification mentioned in (2), above, within ten (10) days of discovery of the defect; and
- 4) Promptly return the RV to an authorized dealer for repairs.

For warranty service; contact one of Mandalay's independent, authorized service centers for an appointment and then deliver your RV to the service center on the specified appointment date. If you need assistance contact Mandalay at (866) 919-4444. The mailing address is: PO Box 1486, Elkhart, Indiana 46515.

If two (2) or more service attempts have been made to correct any covered defect that you believe impairs the value, use or safety of the RV, you must, to the extent permitted by law, notify Mandalay directly, in writing, of the unsuccessful repair of the alleged defect so that Mandalay can become directly involved in making sure that you are provided service pursuant to the terms of this limited warranty.

Because Mandalay does not control the scheduling of service work at any service center you may encounter delays in scheduling and/or the completion of work. All costs associated with transporting the RV for any warranty service shall be the sole responsibility of the RV owner.

WHAT IS NOT COVERED

This limited warranty does not cover any material, component or part of the RV that is warranted by another entity, including, by way of example, the automotive chassis and power train, including the engine, drive train, steering, handling, braking, wheel balance, muffler, tires, tubes, batteries and gauges, generator, hydraulic jacks, inverter, range, carbon monoxide detector, furnace and roof air conditioner.

Minor adjustments such as adjustments to the interior or exterior doors, drawers, latches, etc. will be performed by the dealer during the first 90 days of warranty coverage. Thereafter, such adjustments are the owners' responsibility as normal maintenance.

In addition, By way of example, only, this Limited Warranty does not cover any of the following: items that are added or changed after the motorhome leaves Mandalay; any RV used for rental or other commercial purposes, normal wear, tear or usage, such as fading or discoloration of fabrics or the effects of condensation inside the RV; items that are working as designed but that you are unhappy with because of the design; problems related to misuse, including failure to maintain RV in accordance with the owner's manual, or other routine maintenance; damage due to accident, whether or not foreseeable, including any acts of weather or damage or anything due to the environment, rust, theft, vandalism, fire, or other intervening acts not attributable to Mandalay; damage resulting from tire wear or tire failure; defacing, scratches, dents, chips on any surface or fabric of the RV; damage caused by off road use, overloading the RV or alteration of the RV, or any of its components or parts.

LIMITATIONS AND DISCLAIMER OF IMPLIED WARRANTIES

The following limitations and disclaimers apply to the original purchaser of the RV, any person to whom the RV is transferred and any person who is an intended or unintended user or beneficiary of the RV.

ANY IMPLIED WARRANTY ARISING BY WAY OF STATE OR FEDERAL LAW, INCLUDING ANY IMPLIED WARRANTY OF MERCHANTABILITY OR ANY IMPLIED WARRANTY OF FITNESS, ARE LIMITED IN DURATION TO THE LENGTH OF THIS LIMITED WARRANTY AND ARE LIMITED IN SCOPE OF COVERAGE TO THOSE PORTIONS OF THE MOTORHOME COVERED BY THIS LIMITED WARRANTY. PERFORMANCE OF REPAIRS OR NEEDED ADJUSTMENTS IS THE EXCLUSIVE REMEDY UNDER THIS LIMITED WARRANTY OR ANY IMPLIED WARRANTY. Mandalay makes no warranty of any nature beyond that contained in this limited warranty. No one has the authority to enlarge, amend or modify this limited warranty. The dealer is not Mandalay's agent, but is an independent entity.

In addition, **MANDALAY SHALL NOT BE LIABLE FOR ANY INCIDENTAL OR CONSEQUENTIAL DAMAGES THAT MAY RESULT FROM BREACH OF THIS LIMITED WARRANTY OR ANY IMPLIED WARRANTY. THIS EXCLUSION OF CONSEQUENTIAL AND INCIDENTAL DAMAGES SHALL BE INDEPENDENT OF ANY FAILURE OF THE ESSENTIAL PURPOSE OF ANY LIMITED WARRANTY, AND THIS EXCLUSION SHALL SURVIVE ANY DETERMINATION THAT THIS LIMITED WARRANTY OR ANY IMPLIED WARRANTY HAS FAILED OF ITS ESSENTIAL PURPOSE.**

Some states do not allow limitations on how long an implied warranty lasts, or the exclusion or limitations of incidental or consequential damages. Therefore, the above limitations may not apply to you.

LEGAL REMEDIES/ARBITRATION

In consideration for Mandalay providing this limited warranty you agree that, in the event that you become dissatisfied with the RV, Mandalay or the selling dealership, for any reason, and are unable to resolve your complaint(s) with Mandalay, then you agree to submit your dispute to binding arbitration. See the Alternative Dispute Resolution Agreement for details.

Any action to enforce any portion of this express, limited warranty, or any implied warranty, shall be commenced within one (1) year after expiration of the warranty coverage period designated above. Any performance of repairs shall not suspend this one-year limitation period from expiring. Any performance of repairs after the warranty coverage period has expired, or performance of repairs regarding any thing excluded from coverage under this limited warranty shall be considered "good will" repairs, and they will not alter the express terms of this limited warranty, or extend the warranty coverage period or this limitation period. In addition, this warranty is not intended to extend to future performance, and nothing in this warranty, or any action of Mandalay, shall be interpreted as an extension of the warranty or this limitation period.

THIS WARRANTY GIVES YOU SPECIFIC LEGAL RIGHTS. YOU MAY HAVE OTHER RIGHTS THAT VARY FROM STATE TO STATE.

Four Winds International Corporation · PO Box 1486 Elkhart, IN 46515

Phone: (866) 919-4444

Fax: (574) 522-4276

Website: www.mandalaycoach.com

Customer Care Roadside Assistance Plan

A special peace-of-mind roadside assistance plan is provided free of charge by Mandalay for the first year of ownership. (Rental and lease back vehicles are excluded from this program.)

Some companies will tell you customer satisfaction is a nine to five job...

We know better!

When you take delivery of your new Mandalay RV it's just the beginning of our exclusive around the clock **Customer Care** Roadside Assistance Program.

Our extensive support program provides complete and fully paid roadside assistance, emergency road service (just show your card and go) and special support benefits that follow you wherever your travels take you.

Mandalay has teamed up with Coach Net, the largest RV emergency roadside service provider in the country, to give you immediate access to fast, dependable service when and where you need it. To request service contact Coach Net at: 800-232-4308.

Our exclusive 24-hour *Customer Care* Assistance Benefits include:

- EMERGENCY ROADSIDE ASSISTANCE

Simply show your Thor Industries **Customer Care Card** for payment of covered benefits with no out-of-pocket expense throughout the U.S. and Canada. (Includes one additional family car!)

- 24-HOUR TOLL FREE EMERGENCY MESSAGE SERVICE

In the event of an emergency, stay in touch with family and friends with no cost emergency message service.

Getting in an accident while traveling in your RV means you're stuck. We take care of you by paying for a car rental, meals and lodging. Even helping with a plane ticket home!

- FREE CUSTOM TRIP ROUTING AND FULL COLOR MAP SERVICE

Make your next trip more enjoyable through our partnership with Rand McNally,

the first name in "Getting you there."

-TOLL FREE NATIONWIDE SERVICE APPOINTMENT ASSISTANCE

A “no-hassle” way of arranging a service appointment when and where you travel. We make an appointment for you; give you directions and the time that fits your schedule best. Want an appointment in a town you'll be visiting next week? We're just a phone call away!

- SERVICE ASSISTANCE

Over 6,800 qualified service agencies throughout North America. A simple phone call gives you expert direction on where the closest qualified service agency is located.

- FREE DISPATCH OF ON-SITE MECHANICAL SERVICE IN THE EVENT OF A BREAKDOWN

- FREE JUMP STARTS

- FREE TIRE CHANGES

- FREE FUEL DELIVERY

- FREE LOCK OUT SERVICE

*For further details and instructions on how to access your **Customer Care** benefits, please refer to your Comprehensive Member Benefit Guide which you will receive in the mail within 30 days from the date your registration card is received by Mandalay*

Or call 888- 890-1738

*You may continue your Thor Industries **Customer Care** benefits in following years at a special discount rate, as a continued benefit of the Thor Customer Satisfaction Program.*

The Customer Care Roadside Assistance Program is not available on rental vehicles or lease back vehicles.

SERIAL NUMBERS FOR OWNERS REFERENCE

| |
|---|
| Motorhome Serial Number |
| Motorhome Federal Vehicle Identification Number (VIN) |
| Door Key Number |
| Range Model & Serial Number |
| Microwave Model & Serial Number |
| Refrigerator Model & Serial Number |
| Generator Model & Serial Number |
| Roof Air Conditioner(s) Model & Serial Number |
| Inverter Model & Serial Number |
| Misc. |
| Misc. |
| Misc. |
| Misc. |
| Misc. |

Mandalay recommends the customer records the information for future reference. Some of the information may be found included with Vendor information supplied at time of sale.

OWNER'S PERSONAL PROPERTY RECORD

ITEM

SERIAL NUMBER

VALUE

| | | |
|--|--|--|
| | | |
| | | |
| | | |
| | | |
| | | |
| | | |
| | | |
| | | |
| | | |
| | | |
| | | |
| | | |
| | | |
| | | |
| | | |
| | | |
| | | |

OWNER'S INSURANCE INFORMATION

COMPANY:

POLICY #:

AGENT'S NAME & ADDRESS:

BUSINESS PHONE #:

EMERGENCY PHONE #:

RENEWAL DATE(S):

NOTES:

INTRODUCTION

It's exciting taking ownership of a new purchase as substantial and full of nearly unlimited possibilities for the future as a motorhome.

Thank you for choosing a Mandalay product.

We take your choice seriously. That's why we've engineered this vehicle to meet and, in many cases, exceed federal and state regulations and requirements for vehicles of this type. Our primary concern has been to provide our customers with a beautiful recreational vehicle that is not only dependable and cost effective, but also safe.

To keep this vehicle at peak performance and to obtain the maximum pleasure from its use over an extended period, the owner must take a personal interest in its care and operation. Therefore, before operating it, we suggest that you review the entire contents of this manual. The material within has been prepared in sufficient detail to be of considerable help when you are getting to know your new recreational vehicle.

That is the purpose of this Owners Manual. It outlines the operation of the unit's various systems and offers many helpful hints that will enable you to obtain the most pleasure from this recreational vehicle.

Review both this manual and the chassis manufacturer's owner's manual with your dealer. Be sure to ask them any questions you have at that time. Also make sure to read all warranty and registration information carefully. Read all component manufacturers' owner's manuals, and validate any individual warranties by completing and mailing individual warranty cards as required.

Refer to the chassis owner's manual supplied by the chassis manufacture for complete information on the care and maintenance of the chassis.

COMPLETE THE WARRANTY REGISTRATION CARD IN THIS MANUAL AND RETURN TO US WITHIN 10 DAYS FROM THE DATE OF PURCHASE.

Always keep this owners manual with the recreational vehicle for easy reference, making sure to observe all notes and warnings associated with the use of this recreational vehicle. A careful owner is the best insurance against an accident.

THIS OWNERS MANUAL IS AS CURRENT AS POSSIBLE AT THE TIME YOUR RECREATIONAL VEHICLE WAS PRODUCED. HOWEVER, SINCE OUR PRODUCTS ARE CONSISTENTLY BEING UPGRADED AND IMPROVED; SOME DIFFERENCES MAY OCCUR BETWEEN THE DESCRIPTION IN THIS MANUAL AND THE PRODUCT IN THE RECREATIONAL VEHICLE. IF THIS OCCURS FOLLOW THE COMPONENT MANUFACTURE'S INSTRUCTIONS PROVIDED IN THEIR LITERATURE.

SOME OF THE PRODUCTS SHOWN IN THIS MANUAL MAY BE OPTIONAL EQUIPMENT NOT INCLUDED OR AVAILABLE WITH YOUR RV. ANY SPECIAL EQUIPMENT, MODIFICATIONS, OR ADDITIONS MADE BY OR AT THE REQUEST OF THE CUSTOMER, OR ANY SUBSEQUENT OWNER, WHETHER MADE AT THE FACTORY OR IN THE FIELD, ARE NOT COVERED IN THIS MANUAL. WE RESERVE THE RIGHT TO CHANGE THE CONSTRUCTION OR MATERIAL OF ANY PARTS AT ANY TIME WITHOUT INCURRING THE OBLIGATION TO INSTALL SUCH CHANGES ON DELIVERED UNITS.

Your RV has had a thorough inspection before it was shipped to your dealer. However, to insure your complete satisfaction, the dealer must perform an inspection of various components and operations based on a pre-delivery inspection list provided. You should take the opportunity to cover the operation of all components of your RV with your dealer. This will help make you familiar with the RV and its operation, while at the same time providing you with the assurance of everything being in proper working order. A road test by the dealer should be included as part of the pre-delivery inspection. The dealer can then check for and correct any steering problems before you take delivery of the RV. After this road test has been completed, front end alignment and/or vibrations will not be covered as part of the new vehicle warranty.

This RV has been designed for short term and recreational use. It was not designed to be used as a permanent dwelling or as a rental vehicle. If you intend to use your RV as a permanent dwelling or rental vehicle, it could cause the carpet, drapes, upholstery, and interior surfaces to deteriorate prematurely. This premature wear caused by long term or permanent residency may, under the terms of the new vehicle warranty, be considered abnormal and abusive and **COULD REDUCE YOUR WARRANTY COVERAGE.**

Should a problem develop for which you need assistance, contact your dealer. If the problem is automotive, the motorhome should be taken either to a chassis manufacturer service center or dealer. If the problem is with an appliance, check the appliance manufacture's information supplied with the RV for information regarding warranty work and/or location of appliance service centers.

If, when traveling, you experience a breakdown or problem while your RV is under warranty, and an authorized service center or dealer is not available, if possible, contact the dealer you purchased your RV from, or a Mandalay Technical Service Advisor at (866) 919-4444 before having any service work performed. By notifying them, you will know what is covered under the terms of your warranty, as well as making them aware of your problem. **Any parts that require replacement, that are covered under the terms of the warranty should be retained and returned to your dealer along with your invoice.** This way, they are able to check what has occurred, and also make sure you are properly reimbursed.

Repairs made without prior authorization may be subject to denial or partial reimbursement. Modifications made to the vehicle without proper authorization can result in reduction or loss of warranty coverage. Please make sure to contact your dealer before making such changes.

TRAVEL PREPARATION

Like any vacation trip, pre-planning will pay big dividends. A checklist is often helpful.

In addition to routine trip preparations such as having newspaper delivery stopped and mail held at the post office, there are now more vehicle-related preparations than there were with the old family car.

CHASSIS CHECKS

As with any vehicle, the RVer needs to check the automotive systems prior to a trip. They include:

Under Hood:

- Fluid levels (oil, power steering, radiator, transmission, windshield washer, etc.)
- Belts (tension and condition)
- Battery (electrolyte level if applicable, connections, charge)
- Hoses (clamps tight, condition, leakage)
- Seals, gaskets (leaks)

Exterior:

- Tire pressure/condition and lug nut torque
- Headlights, running and safety marker lights including brake and turn signal and also any trailer light connections
- Security of any auxiliary equipment such as TV and CB antennae, awning, etc.
- Windshield wiper blades
- Generator compartment
- Fresh and waste water connections/drains and supplies such as high pressure hose
- Liquid Petroleum Gas compartment/tank

Under Vehicle:

- Drive train condition, specifically leaks (U-joints, differential, transmission)
- Brakes, including lines, pads/shoes, seals
- Engine area for pan gasket or other leaks
- Anything unusual hanging or tangled with road debris such as tree limbs
- Tank condition (gas, fresh water, waste water)

Inside Driver's Compartment:

- Check operation of all systems, including: Wipers, windshield, horn, brakes, steering, transmission, heater, defroster, air conditioner, and seat adjustment.

Also idle engine long enough to check cooling system and alternator operation. Be sure to turn on headlights and climate controls to see if alternator handles the additional drain on the electrical system (should not show discharge).

RV System Check:

As an RVer you now have the added responsibility to prepare the living quarters for a trip.

Preparations include:

- Filling fresh water tank. In winter make sure that system is freeze protected.
- Check list of food, utensils and clothing needs.
- Check storage of all items, making sure that everything is secured and that heavy items are stored low so they don't fall.
- Check operation of stove and refrigerator.
- Check paperwork such as owners registration card, vehicle registration, proof of insurance, driver's license and names/phone numbers of individuals you are to contact during the trip, such as ranger stations.



WARNING: Pay careful attention to where and what type of flammable materials you store. Certain storage areas are clearly labeled **DO NOT STORE COMBUSTIBLE MATERIALS**. Examples of spark producing areas, depending on RV model, are: base kitchen cabinets, front dinette base, exterior refrigerator service compartment, as well as refrigerator cabinet. *Please use your discretion as to what potentially dangerous products your RV contains while traveling. Be sure all canisters and bottle tops are secure and leak free.*

Tank Capacities - Chart *

| Models | 38A | 38B | 40B | 40C |
|-------------|----------|----------|----------|----------|
| Hot Water | 10 gal | 10 gal | 10 gal | 10 gal |
| Fresh Water | 110 gal | 110 gal | 110 gal | 110 gal |
| Black Tank | 55 gal | 55 gal | 55 gal | 55 gal |
| Grey Tank | 66 gal | 66 gal | 66 gal | 66 gal |
| Fuel Tank | 100 gal | 100 gal | 100 gal | 100 gal |
| LP Tank | 121.5 lb | 121.5 lb | 121.5 lb | 121.5 lb |

* Capacities are approximate and specifications are subject to change without notice.

FIRST SHORT TRIPS

After becoming familiar with the vehicle's systems and going through test runs on items such as Liquid Petroleum Gas (LPG), it is time to take one or two short test trips, including spending the night at a campground not too distant from your home..... you might want to go back and get something you forgot or didn't know you needed.

These short trips could be considered "shake down cruises" or "familiarization flights". The experience gained on these short trips will be worth the time and money to you... Time and money spent either needlessly, taking something that takes up space or the time and money spent trying to obtain an item you hadn't counted on needing prior to leaving home base on an extended trip miles from home and in unfamiliar surroundings.

It is understandably upsetting having to purchase a needed item on the road knowing that one is sitting at home unused.

Not all RVers need the same equipment or supplies. For one thing, North America presents a wide variety of climates and terrain. For another, personal needs and taste come into play.

Our suggestion is to take a weekend trip to a camp location that is close to home. Be sure to have a note pad and pen available to write down items you feel will be needed in the future as well as equipment that you may need to learn more about.

Also, if most of your trips will be made in the summer and your shake down trip is made during some other season, there will be some adjustments to take into consideration. Talk to other RVers and learn from their experiences.

If you are an experienced RVer it is still necessary to thoroughly read this manual. New and improved equipment is coming onto the market every day and, at the same time, not every motorhome manufacturer builds vehicles the same way.

This manual is packed with detail, however, after you have worked with the various systems during a couple of shake down trips, you will be capable of conducting a pre-trip check in less time than it takes to read this manual.

When preparing for your trip always consider vehicle weight when loading the RV.

Because of different RV models Mandalay manufactures and the numbers of options available, your RV may not include all of the systems in this manual.

CARE AND MAINTENANCE

GENERAL INFORMATION

Periodic maintenance and cleaning of your recreational vehicle is necessary to retain the dependability, safety, and appearance that will provide you with many miles of trouble free operation, as well as protecting your investment.

Make sure to read and follow all the maintenance tips and schedules that appear in this manual. Keep good records of maintenance functions performed, and make sure to perform all owner obligations as may be required by the chassis manufacturer to keep your warranty in force.

It is also important to note that operating conditions will affect service timetables. Driving in extreme conditions such as heavy dust, continuous short trips, or start and stop heavy traffic means that service durations will be shortened. Discuss service timetables with both your dealer and chassis service representative. Preventative maintenance will pay for itself many times over by catching or preventing problems before they occur. Many repair costs are greatly increased due to the fact a small problem can begin to affect other parts and systems of the motorhome if left unattended.

If a situation arises involving maintenance or cleaning activity for which you are not sure of the proper procedure, do not hesitate to contact your dealer, or chassis service representative for information.

FIBERGLASS SIDEWALLS

The exterior painted finish on the motorhome is of the finest quality. Proper maintenance will assure a long lasting durable finish.

NOTE: DO NOT Wax or polish the exterior for the first 60 days.

NOTE: DO NOT use rubbing compound or other abrasive cleaners on the motorhome exterior. If using a tar and/or insect remover, insure it is safe for painted surfaces and decals.

Precautionary Measures:

Parking

- Avoid parking under trees or near ocean salt spray.
- Ice or snow should not be scraped from the painted surface: Brush off.
- If the motorhome sets more than 24 hours, remove any front protective covering (bra) while not being driven.

Washing

- Commercial washes should be avoided.
- Wash with cold water using a mild liquid soap.
- Dry wiping with a dry cloth is not recommended.

Driving

- Avoid gravel roads.
- Anti-freeze, gasoline, or window solvent spilled on painted surfaces should be rinsed off with water immediately.
- Rinse off bugs and bird droppings daily with water.

Any exterior finish will deteriorate with time. Dulling and fading can be increased by prolonged exposure to extreme sunlight, air pollutants, and excessive moisture. Surface weathering of fiberglass will not diminish structural integrity. Regular monthly washing and waxing of exterior surfaces is the best insurance against surface deterioration such as fading, yellowing, or chalking. Take care to avoid spraying water directly into refrigerator and furnace vents when washing the motorhome.

If surface deterioration is apparent, contact a Mandalay dealer for assistance with finish restoration. Physical damage to the fiberglass, such as cracks, holes, and chips, must be attended to immediately to avoid moisture from entering and causing problems with interior walls and components. Cover these areas with plastic, sealing the edges with tape until proper repairs can be made.

SEALS AND ADHESIVES

It is important to maintain the seals and adhesives of your RV to prevent moisture from entering and destroying your RV components. When washing your RV, inspect the seals for signs of drying out and wear. Be aware that weather, sun, and road vibration will have an effect on seals, causing them to dry, crack, or separate. If you are unsure what to look for, have your dealer instruct you, and also show you the correct method for renewing the seals. All exterior seals should be checked and resealed as needed at least every 6 months. This also includes your roof components as well. Check with your dealer for the type of caulking required, different areas require different types of seals. It is especially important to check the seals before and after periods of extended storage or non-use. Fall and spring inspections are recommended.

NOTE: If your roof should somehow be punctured, cover the puncture to seal out moisture, and have it repaired as soon as possible.

EXTRUSIONS AND ALUMINUM SURFACES

Clean and wax all extrusions when waxing the RV sidewalls, to help avoid surface pitting. Special aluminum cleaners are available to restore the original luster to aluminum surfaces. Make sure to follow the instructions for use as outlined on the product package. Chrome surfaces can be restored with special chrome polish if regular cleaning methods are not successful. Again, make sure to follow product instructions for use.

WINDOWS AND DOORS

Check the seals around windows at regular intervals. Follow previous instructions for checking the condition of seals and repairing as necessary. Make sure that the windows remain operative by adjusting and lubricating latches and moving parts annually. Also check the condition and operation of the door locks, adjusting and lubricating as necessary. Use powdered graphite or light oil to lubricate moving parts on doors and windows. Vinyl seals around windows and doors should be cleaned regularly, and kept supple by use of a silicone spray.

Keep screens and window slides clean and free of debris, to maintain proper operation, and avoid component road damage. Test the operation of all windows occasionally to make sure they are working properly, including closing flush and locks holding tight. Check with your dealer if you are unsure about the correct methods of lubrication and adjustment.

NOTE: Be aware that moisture can accumulate in locks and hinges of windows and doors, causing damage or faulty operation. Do not force the operation of these components in sub-freezing weather.



CAUTION: Failure to maintain seals through regular maintenance can lead to damage of your motorhome components, and may be considered abusive treatment under the terms of your RV warranty.

FRAME

Check the condition of the frame regularly. Keep it clean, and repaint as necessary to help avoid rust. It is especially important to keep underbody components clean, when driving the recreational vehicle in the winter in areas where road salts are used.

TIRES

In areas where hot sun constantly beats down on the recreational vehicle, shading the tires by covering can reduce tire sidewall cracks from forming.

ROOF

Inspection of roof components at least twice a year is very important to make sure seals are not cracked or worn. Proper maintenance of seals is necessary to keep moisture from entering and causing severe damage such as rot, mold, or mildew. If you encounter drying, cracked, or weathered seals, make sure to reseal as necessary. Check with your dealer for the type of caulking required for roofs and correct methods of resealing. Special sealers are also required for the skylights.



CAUTION: It is especially important to check the seals before and after periods of extended storage or non-use. Fall and spring inspections are recommended.



WARNING: Some products may contain hazardous materials which require special handling. Read labels carefully. Follow all of the product manufacturer's safety requirements.

NOTE: If your roof should somehow be punctured, cover the puncture to seal out moisture, and have it repaired as soon as possible (check with your dealer).

TV ANTENNA

To lubricate the elevating gear, apply a liberal amount of silicone spray lubricant to the elevating gear with the lift in the down position. Run the lift up and down a few times to distribute the lubricant over the gears.

If rotating the antenna becomes difficult, normal operation can be restored by lubricating the bearing surface between the rotating gear housing and the base plate. Any spray type silicone lubricant may be used.

Elevate the antenna and remove the set screw from the rotating gear housing (see illustration). Spray lubricant into hole and around the edges of the gear housing. Rotate the gear housing until the lubricant coats the bearing surfaces and the antenna rotates freely.

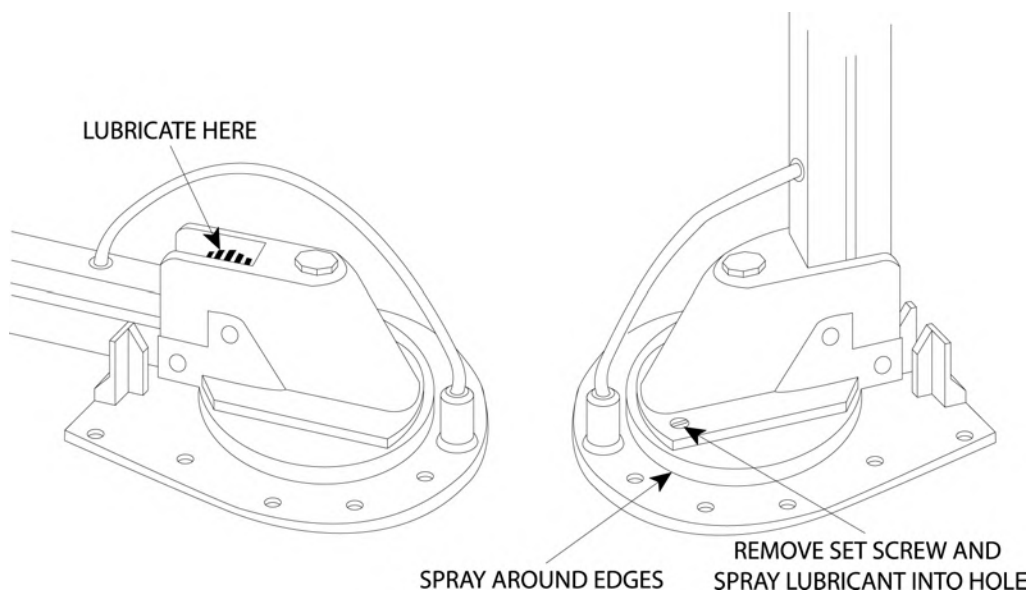

EXTERIOR LIGHTS

Make sure to check the operation of all exterior lights often. Check identification, clearance, turn signal, brake, and backup lights to make sure they are working correctly. Replace burnt out bulbs as soon as possible.

APPLIANCES, SINKS AND COUNTERTOPS

Clean with hot soapy water or a good liquid cleaner. Avoid using abrasive cleaners. Never use steel wool on stainless steel, since the steel particles left in the sink can rust and become unsightly. Also, when cleaning stainless steel with a mild cleanser, rub gently with the grain, and rinse well. Rinse after each use and wipe dry.

Be sure to remove all food and ice from the refrigerator at the end of each trip. Prop the door open slightly to keep the interior dry, and free of mold, mildew, and odors.

Make sure to read all literature provided with each of the appliances, and follow the maintenance instructions included. Pay particular attention to any cautions or warnings included. Also read the rest of this manual, following the instructions for the care and use of appliances.

Do not place hot pans directly on countertops, because they can loosen or scorch surface.

PRE-FINISHED PANELS AND WOOD SURFACES

Treat cabinetry and wood surfaces as you would any fine furniture product in your home. Proper care and maintenance of wood products will keep them looking like new for many seasons of use.

Clean pre-finished panels with a spray-type furniture polish. Avoid getting wood surfaces wet. Wipe off and dry immediately if you do get wet. Do not use abrasive cleansers around wood finishes. Clean regularly with a soft cloth and cleaner designed for wood products such as lemon oil or any oil based wood cleaning product. Avoid constant exposure to direct sunlight which can cause fading and drying of wood surfaces.

WATER SYSTEM

Check all hoses, fittings, and connections regularly for leaks and signs of wear. Make sure to keep the system sanitized, and take care to winterize during cold weather (see instructions elsewhere in this manual). Do not allow water to remain in system for extended periods or after a trip.

ELECTRICAL SYSTEM

The electrical system requires minimal maintenance under normal circumstances. Most electrical maintenance in the recreational vehicle involves the chassis and auxiliary batteries. Keeping the batteries properly maintained will help to eliminate many frustrating electrical problems. Make sure to refer to the index for the location of electrical and battery maintenance information elsewhere in this manual.

The generator is another area in which simple preventive maintenance can "head off" problems before they happen. Read the manual supplied with the generator for the care and maintenance required on a regular basis. The first scheduled maintenance should be at 50 hours, followed thereafter with regular service intervals of 150 hours.

If you experience electrical problems with your recreational vehicle, make sure to have it checked by a qualified electrician.

ROOF VENTS

Check roof vents regularly for debris that may block air flow or jam the cranking mechanism. Lubricate the cranking mechanism with light oil.

ABS PLASTIC

Many components of the recreational vehicle are constructed of strong, lightweight ABS plastic. Sometimes, it may be necessary to remove stains, or generally clean. A mild solution of soap and water will clean many stains and should be used initially. Tougher stains may require stronger cleaners, but be sure to read the label to determine if the product is recommended for use on plastics.

Avoid abrasive cleanser (even the liquid and cream types), alcohol based products, and solvents such as acetone and MEK. Gasoline and kerosene should not be used because of the damaging effect they have on the plastic surface, as well as the fire hazard they present. Often the damage caused by solvents, alcohol, and oil based products may not be immediately noticeable, but the plastic is made weaker, and prone to stress cracking.

WINTER PRECAUTIONS

SPECIAL TIPS FOR WINTER USE

Water Systems – If the fresh water storage tank is located inside the coach, the normal heating of the coach during cold weather should be enough to insure its not freezing. In severe cold weather (40°F or Lower) however, it is wise to monitor the water temperature in the tank, and take appropriate steps to drain and winterize if necessary. In severe cold it may be necessary to open lower cabinet doors at night in both the bath and kitchen areas to keep warmer air circulating around water fixtures.

If you are going to leave the coach unheated for any length of time in severe cold conditions, it is best not to keep water in the fresh water tank. It may work best to carry cooking and drinking water with you in plastic jugs instead.

If you will be using your recreational vehicle when conditions fall below the freezing level, it will be necessary to protect the drainage system components from damage by the addition of an approved antifreeze solution as outlined on the product directions. Drain lines which are exposed outside the recreational vehicle are especially susceptible to freezing, and steps should be taken to protect them from damage.

Food Storage – In the event the recreational vehicle is left for a period of time without the furnace in operation, canned goods and other foods packed in water should be stored as high as possible, since heat rises. They might also be stored in the refrigerator as insulation against the cold. Store dry foods, and other items that are not damaged by freezing, in the lower storage areas.

LP Gas System – Make sure to use an LP gas that will vaporize properly in the colder temperatures. Check with your LP gas representative for the proper fuel, and reread the information on LP gas selection in the LP Gas section of this manual (check the Index for the location).

NOTE: It is important to remember that heating with LP consumes gas rapidly, so refill tank immediately when low, to avoid running out completely.

Heating – Use ONLY the furnace to heat the recreational vehicle. It is properly vented to the outside.



WARNING: NEVER USE THE RANGE FOR HEATING - ASPHYXIATION COULD RESULT.

Condensation – Cooking produces large amounts of moisture. Not just as steam from pots and pans, but also as a product of combustion. Make sure to use the exhaust vents and open a window slightly to control the humidity. At night, leave a roof vent and/or a window slightly open.

STORAGE PREPARATION

When storing the recreational vehicle for the winter (or other extreme conditions), certain precautions need to be made to protect it until you open it again for use. Make sure to talk with your local dealer concerning any special requirements for storage in your particular geographic area. The following steps are general, and your dealer can help you choose those that are most appropriate for your needs.

1. Make sure to park the recreational vehicle on a level surface.
2. Make sure to winterize the chassis as outlined in the chassis owner's manual, and also the 110V generator (if so equipped) as outlined in the generator's owner's manual.
3. Clean the recreational vehicle thoroughly, both inside and out, as previously outlined, including the refrigerator.
4. Make sure all electrical switches and appliances are turned off.
5. Close all the drapes and curtains, and protect the curtains from sun fading by placing foil, or paper between the windows and the screens.
6. Make sure all windows, doors, and vents are closed securely. Cover exterior vents on appliances to prevent moisture and insects from entering during storage.
7. Check the interior of the recreational vehicle periodically while in storage to make sure leaks have not developed, or condensation formed that can cause damage to interior components. Condensation can most readily be observed as moisture accumulation on windows and mirrors. To reduce condensation, make sure to air the recreational vehicle out occasionally during storage.
8. Be sure that both the chassis and coach batteries have the proper electrolyte level and that they are fully charged (specific gravity of 1.260). A discharged battery will freeze and crack the case, ruining the battery. In storage, a battery will lose charge gradually over a 30 to 45 day period, even when disconnected by use of the battery disconnect switch. We recommend that at least monthly the batteries be checked for charge. If the charge is 80% (specific gravity of 1.235) or less, it must be recharged.

You may wish to remove the batteries from the recreational vehicle and store them in a heated area. However, even when warm, the battery charge level must still be maintained. A warm battery accepts charge much more readily however, than a cold one.

Make sure to follow all precautions associated with battery care and maintenance outlined in the electrical section of this manual.

9. Store with as much fuel as possible in the fuel tank to limit condensation buildup.
10. Check engine coolant, making sure antifreeze is sufficient for local temperature extremes.
11. Make sure the tires are inflated to correct pressures.
12. Store the windshield wiper arms and blades inside the motorhome.
13. Let the engine run for a period of time until it is warm. Change the oil and oil filter.
14. Run the air conditioner during this final engine warm up to make sure the compressor seal is lubricated.
15. If snow accumulates on the recreational vehicle, try to remove it as often as you can.
16. A primary concern when winterizing the recreational vehicle is to make sure the water systems are protected against damage caused by freezing. Follow the water system winterizing procedure outlined in the Water and Drainage section of this manual (check the index for location).

Be sure to read the rest of this manual, and follow any additional information on storage, cleaning and winterizing procedures.

PERIODIC MAINTENANCE CHART

| ITEM | Ea. Trip | Ea. Mo | 3 Mo | 6 Mo | Ea Yr | As Req | PROCEDURE |
|------------------------|----------|--------|------|------|-------|--------|--|
| Fiberglass Exterior | | X | | | | | Wash with warm water & mild detergent |
| | | | | X | | | Wax with liquid or paste wax |
| Roof & Roof Components | | | | X | | | Inspect & re-seal as needed |
| | | | | | X | | Lubricate roof vent mechanism w/light oil & clean completely |
| Windows & Doors | | X | | | | | Check vinyl seals when washing exterior |
| | | | X | | | | Check seals for damage & repair as needed |
| | | | X | | | | Lubricate door hinges & step components with WD40 |
| | | | | | X | | Adjust & lube window latches with powdered graphite or light oil |
| | | | | | X | | Lube door locks & strike pocket, incl. ext. storage & access drs |
| Seals & Adhesives | | X | | | | | Inspect & reseal as necessary |
| LP Gas System | | | | | | X | Check for leaks & road damage |
| | | | | | X | | Have qualified serviceman check pressures & complete system |
| Water Drainage | | X | | | | | Check hoses, fittings & connections for leaks & signs of wear |
| | X | | | | | | Check drainage system for leaks & road damage |
| | | | | | | X | Sanitize system |
| | | | | | X | | Winterize system depending on local seasonal conditions |
| Electrical System | | X | | | | | Check GFCI circuits |
| | | | | | | X | Perform maint. on generator as outlined in generator manual |
| | | | | | | X | Check & service batteries |
| Appliances | X | | | | | | Remove food & ice from refrigerator after each trip |
| | | X | | | | | Clean fan blades & wash filter on range exhaust hood |
| | | X | | | | | Check for obstructions & dirt on exterior appliance vents |
| Safety Equipment | | | | | X | | Clean smoke detector components |
| | X | | | | | | Test smoke detector operation |
| | | X | | | | | Check fire extinguisher pressure & condition |
| Carpeting | X | | | | | | Vacuum after each trip |
| | | | | | | X | Clean |
| Wood Surfaces | | X | | | | | Clean pre-finished panels & wood |
| Seats | | | | | | X | Lubricate all mechanisms & inspect for proper operation |
| | | | | | | X | Check all seat belt buckles, release mechanisms & belt webbing |
| Chassis & Components | | | | | | X | Follow chassis lubrication & maint procedures & schedules |
| Weight & Distribution | X | | | | | | Be sure unit is within specified load limits & weight distribution |



IDENTIFICATION AND SAFETY

REPORTING SAFETY DEFECTS

The following note is added as a requirement of the National Highway Traffic Safety Administration (NHTSA):

If you believe that your vehicle has a defect that could cause a crash or could cause injury or death, you should immediately inform the National Highway Traffic Safety Administration (NHTSA) in addition to notifying the manufacturer.

If NHTSA receives similar complaints, it may open an investigation, and if it finds that a safety defect exists in a group of vehicles, it may order a recall and remedy campaign. However, NHTSA cannot become involved in individual problems between you, your dealer, or the manufacturer.

To contact NHTSA, you may either call the Auto Safety Hot-line toll free at 1-888-327-4236 or go to their website at www.nhtsa.dot.gov. You can also obtain other information about motor vehicle safety from these sources.

RECREATIONAL VEHICLE SERIAL NUMBER DECALS, AND DATA PLATES

The recreational vehicle serial number label is mounted on the inside wall next to the driver seat. Refer to the chassis owner's manual for the location of the chassis vehicle identification number on all motorized recreational vehicles.

IMPORTANT: Always give model, year, and the V.I.N. number information when ordering parts. Also, we recommend that you keep a copy of this information separate from the RV in the event that theft or vandalism requires you to supply a copy to authorities.

| | | |
|---|-------------------------------------|-------------------------------------|
| MANUFACTURED BY: FOUR WINDS INTERNATIONAL INC. VEH. MFG. BY: | MODEL: SERIAL: | Offline: Received: |
| <u>KG (LB)</u> | <u>TIRES</u> | <u>RIMS</u> |
| | <u>COLD INFLATION PRESSURE</u> | <u>SINGLE</u> |
| GVWR: | | <u>DUAL</u> |
| GAWR FRONT: | <input checked="" type="checkbox"/> | |
| GAWR INTERM: | <input type="checkbox"/> | <input type="checkbox"/> |
| GAWR REAR: | <input type="checkbox"/> | <input checked="" type="checkbox"/> |

THIS VEHICLE CONFORMS TO ALL APPLICABLE U.S. FEDERAL MOTOR VEHICLE SAFETY STANDARDS IN EFFECT IN:
V.I.N.: **TYPE:** MULTI PASSENGER VEHICLE

Decals and data plates are used throughout the RV to aid in its safe and efficient operation; others give service instructions. Read all decals, data, and instruction plates before operating your RV.

When any decal, data, or instruction plate is damaged, painted over, removed, etc. it should be replaced.

MANUFACTURER'S WARRANTIES

The following list of components has been compiled to help you know which products on your RV may have their own warranties. If you have any of these components on your RV, be sure to check your literature supplied by the manufacturer to see if they require that you register your purchase with them to validate their warranty. We recommend that you send the various warranty registration cards immediately before any time constraints on registration expire. Manufacturers' literature is contained in a separate packet furnished with the owner's manual on newly delivered units or in the back of this folder. Only those products and options which are on your RV will be included in this packet. You should go over the literature with your dealer during the pre-delivery inspection. Any shortages of literature should be reported to the dealer at this time.

| APPLIANCES | | |
|-----------------------------|------------------|---------------------|
| Air conditioner (roof) | Water heater | Awnings |
| Furnace | Televisions | Home theater system |
| Range | VCR/VCP | DVD player |
| Range hood | Radio | Washer/dryer |
| Microwave oven | Ice maker | Satellite system |
| Refrigerator | Coffee maker | |
| ELECTRICAL | | |
| 110/12V inverter | LP leak detector | |
| Generator | Battery | |
| GFCI receptacle | Smoke detector | |
| Carbon Monoxide Detector | | |
| WATER & DRAINAGE | | |
| Toilet | | |
| Water pump | | |
| Water faucets | | |
| LP GAS | | |
| Regulator | | |
| Gas tank | | |
| Gas leak detector | | |
| CHASSIS | | |
| Air conditioner | Back up monitor | Hydraulic pumps |
| Cruise control | Leveling jacks | Batteries |

SAFETY REGULATIONS FOR LP GAS SYSTEMS AND APPLIANCES

The following warnings are posted throughout your RV to provide information on LP gas safety. They have been installed not only because of the requirement to do so, but also as a constant reminder to occupants of the RV to exercise proper caution when using or being around LP gas appliances and equipment. We are listing them here so you may study them and make sure that you and your family understand and follow them.



The safety alert symbol is used throughout this manual to call attention to warnings where vehicle damage or possible personal injury may be involved.



WARNING: It is not safe to use cooking appliances for comfort heating



WARNING: Cooking appliances need fresh air for safe operation. Before operation:

1. OPEN OVERHEAD VENT OR TURN ON EXHAUST FAN
2. OPEN WINDOW

This warning label has been located in the cooking area to remind you to provide an adequate supply of fresh air for combustion. Unlike homes, the amount of oxygen supply is limited due to the size of the RV, and proper ventilation when using the cooking appliances will avoid dangers of asphyxiation. It is especially important that cooking appliances not be used for comfort heating as THE DANGER OF ASPHYXIATION IS GREATER WHEN THE APPLIANCE IS USED FOR LONG PERIODS OF TIME.

Overfilling the LP gas container can result in uncontrolled gas flow which can cause fire or explosion. A properly filled container will contain approximately 80 percent of its volume as liquid LP gas. An 80 percent automatic shut-off has been installed on the LP gas tank which will automatically prevent further filling when the gas volume has reached 80 percent of tank capacity.



CAUTION: This tank is equipped with an automatic valve designed to close at 80% liquid full. Always open 20% fixed liquid level bleeder gauge while filling. Stop filling if liquid appears before valve shuts off.



WARNING: All LP gas is contained under pressure. Due to the dangerous potential of any compressed gas, it is mandatory that the following requirements for the use of this tank be followed: Tanks are to be installed, fueled and maintained in accordance with the state and local codes, rules, regulations or laws and in accordance with the NFPA Pamphlet 58, division IV.



WARNING: IF YOU SMELL GAS.

- Extinguish any open flames, pilot lights, and all smoking materials.
- DO NOT touch electrical switches
- Shut off the gas supply at the tank valve (s) or gas supply connection.
- Open doors and other ventilation openings. (DO NOT USE THE RANGE HOOD)
- Leave the area until the odor clears.
- Have the system checked and leakage source corrected before using again.

LP gas regulators must always be installed with the diaphragm vent facing downward. Regulators that are not in compartments have been equipped with a protective cover. Make sure that the regulator vent faces downward and the cover is kept in place to minimize vent blockage which could result in excessive gas pressure causing fire or explosion.



WARNING: Portable fuel burning equipment including wood or charcoal burning grills and stoves shall not be used inside the vehicle because they may cause fire or asphyxiation.

FIRE SAFETY

Fire safety is an important part of owning a RV. The following basic rules of fire prevention can help eliminate the possibility of a fire.

Make sure that everyone in your vehicle is familiar with the location of exits, including emergency exit windows should an emergency arise.

1. Never store flammable liquids in the RV
2. Never leave cooking food unattended
3. Never smoke in bed, and always use an ashtray
4. Never allow children to play with LP gas or electrical equipment
5. Never use an open flame as a flashlight
6. Always repair faulty or damaged wiring and electrical components
7. Never overload electrical circuits
8. Locate and repair LP leaks immediately
9. Keep cooking surfaces clean
10. Don't allow rubbish to accumulate
11. Never clean with a flammable liquid
12. Spray fabrics annually with a flame retardant

If a fire does start, make sure to follow the basic rules of safety:

1. Have everyone evacuate the RV as quickly as possible
2. After everyone is clear, check the fire to see if you can attempt to put it out. If it is large, or the fire is fuel fed, get clear of the RV and have the fire department handle the emergency.
3. DO NOT attempt to use water to put out the fire. Water can spread some types of fire, and electrocution is possible with an electrical fire.

FIRE EXTINGUISHER

UNDERWRITER LABORATORIES CLASSIFY FIRES INTO THREE TYPES:

Class A – Fires in wood, paper, fabric, rubber, and certain plastics.

Class B – Flammable liquids such as grease, cooking oils, gasoline, or kerosene.

Class C – Electrical fires started from live electrical wires, from short circuited motors or switches.

The fire extinguisher provided with the RV is a chemical type suitable for extinguishing small fires of the class B or C type. Extinguishers are designed to put out fires in the initial stage, not when it is blazing out of control. If a fire cannot be approached within 10', your extinguisher will not be effective.

To fight a fire with an extinguisher, first remove the tamper tape which covers the discharge push button. The extinguisher does not need shaking. Hold it upright and stand six to ten feet from the fire with a clear path to an exit. Press the button down all the way, aimed at the base of the fire and spray with quick motions from side to side.

Avoid inhaling the dry chemicals. Although non toxic, they could cause temporary irritation and vomiting. When the fire is out, clean up the area as soon as possible. The dry chemicals are non-corrosive, but some residue may cause surface damage if left too long.

In the case of an electrical fire, disconnect the battery and throw off the main circuit in the unit. It is important that everyone knows where to find the main circuit and how it operates. If the shoreline power cord is connected, disconnect it.

TO KEEP A FIRE EXTINGUISHER IN OPERATING CONDITION:

1. **CHECK PRESSURE**-monthly or more often. Check the nozzle for obstruction. Press the green pin below the nozzle. If it returns and sticks out from the extinguisher, it is operable. If the pin does not come back, discard extinguisher. Refillable models have a pressure gauge to check.
2. **TAMPER TAPE**- Check the tape to make sure it is intact. DO NOT test the extinguisher. Even a partial discharge may cause leakage.
3. **INSPECTION TAG**- when checking the extinguisher for pressure, enter the date checked on the inspection tag furnished with the RV. Regular inspections will help insure the condition.
4. **AGITATE DRY CHEMICAL**- every six (6) months, by inverting the bottle and lightly shaking for several seconds. This will help prevent the dry chemical from settling due to in-motion vibrations.

CARBON MONOXIDE DETECTOR

OPERATING YOUR DETECTOR

See the instructions sheet which came with your detector for complete information. Operating your CO Detector is easy. Once power is supplied, the detector will run through a warm-up and self-check cycle for ten minutes before beginning to monitor for CO gas. There are no switches to allow the unit to be accidentally turned off, so the detector will provide reliable protection (providing that the test procedure is performed) by alerting you to the buildup of potentially dangerous levels of CO gas on a continuous basis.

TESTING THE DETECTOR



WARNING: Carbon Monoxide cannot be seen or smelled and can kill you. If alarm sounds: Turn off appliances, vehicle or other sources of combustion at once (furnace, water heater, stove, RV, automobile, etc.) and call the fire dept. Get fresh air into the premises or vehicle. Have the problem corrected before starting any appliances or vehicle.

Carbon monoxide is a very dangerous gas; it is not wise to use deadly CO to test the operation of the detector. A commonly available source of gas is a butane lighter. Butane is combustible, *but not deadly*. Normally this detector ignores combustible gases. The TEST button will change the sensitivity so butane can be detected temporarily. If the detector will respond to butane, it will respond to CO gas during normal operation. This test will prove that your CO detector is fully operational and that the sensor will detect gas.

TESTING PROCEDURE

This test must be performed quickly. Be sure that you read and are familiar with this test procedure before beginning.

1. Be sure that the detector has been powered for a minimum of 10 minutes.
2. Press and hold test button for approximately 10 seconds.
3. Without releasing the button, aim nozzle of a butane lighter towards the gas sensor area.
4. Press the gas release quickly (not more than 1 second) **DO NOT ROTATE FLINT WHEEL.**
5. Release the test button
6. The alarm should sound. If it does not, repeat this test then see the troubleshooting section in the instructions that came with your unit.
7. Wait 1 minute
8. Press and release the test button to silence the alarm. If the alarm continues to sound, wait 30 seconds and press and release the test button again. **NOTE: The alarm will reset within 5 minutes without pressing the test button.**

HOW OFTEN TO TEST

You must test this detector at least once per week during use. If used in a vehicle or coach, it must also be tested after storage and before each trip.

CARBON MONOXIDE SAFETY PRECAUTIONS



WARNING: Exhaust gas is deadly! It contains carbon monoxide, a poisonous gas that can cause unconsciousness and death. It is an odorless, colorless, and tasteless gas formed during combustion of fuel in either the motorhome or generator engines.



WARNING: Never sleep while the engine is running. It is impossible to know if you are being affected by carbon monoxide gas while asleep.

Be aware of carbon monoxide poisoning and its symptoms:

1. Dizziness
2. Severe Headache
3. Vomiting
4. Weakness and Sleepiness
5. Muscular Twitching
6. Throbbing in Temples

If anyone in the recreational vehicle experiences any of these symptoms, shut off the engine, and immediately go outside into fresh air. Get medical attention as soon as possible.

Never run the engine unless you are sure that exhaust gases will be safely dispersed into the atmosphere. Always be sure that tail pipes remain unblocked and windows near the exhaust are closed.

DO NOT alter or modify any component of the exhaust system at any time. Inspect the exhaust system at regular intervals for damage. If you suspect or locate damage to the system, have it repaired immediately.

SMOKE DETECTOR

An ionization detector offers a broad range of fire sensing capabilities. However, they do possess limitations. Fire could start in a location that would prevent smoke from reaching the detector. They are also better at detecting fast flaming fires than the slow smoldering variety. They are also not a cure for poor fire safety habits. Smoke detectors need occasional maintenance for reliable service. A smoke detector is designed to be relatively maintenance free, but there are three things you can do to keep a detector in reliable working order:

1. **TEST IT-** at least once a week by firmly pressing the button located near the center of the cover. The alarm should sound briefly. If it does not work, replace the battery and test again.
2. **CLEAN-** the detector if grease or dust accumulates. The following procedure should be followed once a year.
 - a. Remove the cover and battery
 - b. Clean dust from sensing chamber openings with a vacuum and soft brush attachment
 - c. Replace the battery and depress the test switch. The alarm should sound briefly. If it does not work, try a new battery.
3. **SERVICE -** the detector if it does not work by sending it to the manufacture or their repair center. DO NOT attempt to make the repairs yourself (other than battery replacement).

NOTE: When the battery is low, the detector will make a "chirping" noise for seven days to remind you to change it.

SEAT BELTS



WARNING: All motorhome occupants should wear their seat belts for maximum protection in the event of a collision. For young children, infant and child restraints should be obtained and used in accordance with the instructions provided for, by the manufacturer of the restraint. In some areas, seat belt and/or child restraint use is required by law.



WARNING: The sleeping accommodations in this vehicle are designed for occupancy only while the vehicle is NOT in motion. All occupants in this vehicle must be seated at a designated seating position and must wear seat belts at all times while this vehicle is in motion. Failure to do so may result in serious injury.



WARNING: In addition to the seat belt operating instructions given here, it is extremely important that you also review and follow all the instructions for seat belt and child restraints in the chassis owners manual provided with your vehicle.



WARNING: Failure to adjust the seat belt properly could increase the chance of injury in the event of a collision.



WARNING: Pilot and Co-pilot seats must be locked in a forward facing position with seat belts fastened while the motorhome is in motion. Avoid seat rotation while in transit. Children must not be transported unrestrained. Infants must be placed in approved safety seats. Small children must be restrained in child safety seats. Failure to comply with these rules can lead to injury or death.

Seat belts are a very important safety feature in your motorhome. Anyone riding in the motorhome should wear a seat belt at all times while the motorhome is in motion. Children should be properly restrained rather than being held by an adult.

Never have more than one person use an individual seat belt. Also it is not possible to belt persons who are lying in a bed.

To fasten seat belts, insert the tongue into the buckle until you hear a snap and feel the latch engage. Adjust the belt to the proper position; snug and as low as possible around the hips, not around the waist. To unfasten the seat belt, push the release button in the buckle and allow the belt to unlatch.

NOTE: Seat belts have been provided at most seating locations within your vehicle to allow the user the flexibility and convenience to choose which seat location they would like to occupy. However, it is not intended for all seats to be simultaneously occupied while the vehicle is in motion without regard to the total loaded weight of the vehicle.

DO NOT EXCEED THE CARRYING CAPACITY OF THIS VEHICLE.

EGRESS EXIT WINDOW

An egress window is designated for use as an exit in the case of an emergency. Inside the motorhome the egress window is easily identified by the red locking handle. It is also marked as an "EXIT". The glass slider in the egress window operates the same as all other windows;

- To open the egress window, lift the red handle and push outward on the window.
- To close the egress window, pull the window closed and lower the handles to lock window in place.



CAUTION: The egress window should be opened twice a year to ensure proper operation. Over time, the rubber seal will tend to stick to the egress window. Occasional operation will help prevent the rubber seal from sticking.

HANDLE IN LOCKED POSITION

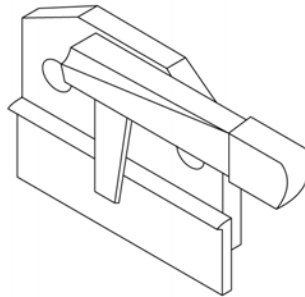

RAISE HANDLE TO OPEN

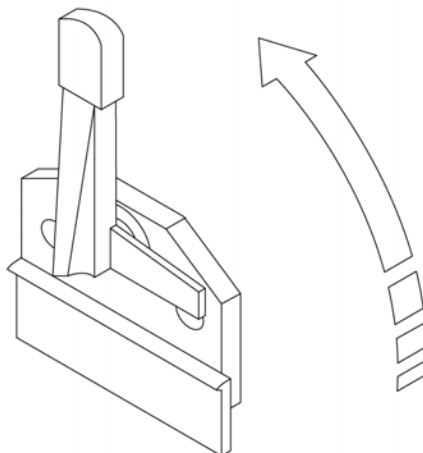

AUTOMOTIVE OPERATIONS AND PROCEDURES

GENERAL INFORMATION

The chassis is the foundation and heart of your motorhome. With proper care and maintenance, it will provide years of service, and many miles of enjoyable travel.

You as the owner are the key to keeping your vehicle in good operating condition, as well as being responsible for taking the proper precautions when attempting any repair or maintenance activities. If you are not sure what action to take, or uncomfortable with performing a maintenance or repair function, contact your dealer, or a designated chassis manufacturer servicing dealer. Check information supplied by chassis manufacturer for a service dealer near you.

Make sure to read all chassis information supplied by the chassis manufacturer, paying particular attention to precautionary notes and warnings, as well as all maintenance procedures and schedules.

NEW VEHICLE BREAK IN

Special procedures or schedules for breaking in your new motorhome are minimal. Make sure to follow the recommendations as outlined in the chassis owner's manual to ensure proper future performance and economy.

BRAKES

Operation and maintenance of the brake system is covered in the chassis owner's manual. Always be sure to keep your brakes in proper working condition, following the service schedule in the chassis literature, and the recommendations of your chassis service representative.

WHEELS AND TIRES

Your motorhome tires play an important role in the load carrying capacity of the vehicle. To ensure good tire life, check tires often. Inspect the general condition of the tires, as well as the air pressure.

Always check the air pressure when the tires are cold. Tires that are hot from traveling will show higher pressures. The maximum tire pressure and the load carrying capacity of the tire is imprinted on each tire sidewall as well as on the vehicle serial number I.D. tag. Always inflate your tires to their correct pressure. Do not over or under inflate. Under inflated tires will run hot, shorten the tire's life and decrease the motorhomes safe load limit. Over inflated tires will cause a rough and bouncing ride that could damage motorhome components or cargo. It is a good idea to always carry an accurate tire pressure gauge in the motorhome to make these checks. If pressure checks indicate that a tire is losing air, check for signs of valve leakage, penetration, or wheel and rim damage.

The way you drive can have a significant effect on the wear and life of tires also. High speeds, unusual use of the brakes, taking corners too quickly, quick starts, and surfaces in poor condition all can attribute to the early wear and failure of your tires.

DAMAGED OR FLAT TIRES



CAUTION: When replacing a tire, make sure to replace it with a tire of the same size and specifications.

If you notice damage to a tire such as a bulge, uneven wear, or damage by a foreign object or the road, have it inspected and repaired or replaced as needed. Remember that tires should be taken to an authorized tire repair facility.

If you experience a flat tire on your RV, it is recommended that you have qualified personnel with the proper equipment handle the problem. Due to the size and weight of a RV wheel and tire assembly, as well as the amount of torque needed to tighten wheel nuts securely, it is best to call in a professional. It is for this reason that a jack has not been included in this motorhome.

WHEEL NUT TORQUES



WARNING: Failure to tighten wheel nuts as required could allow wheels to come off while the vehicle is in motion, causing loss of control and possible collision.

It is also important to have the wheel nuts checked regularly to make sure they have not loosened during travel. Follow the schedule for regular wheel nut checks as outlined in the chassis manufacturer's owner's manual. If you suspect that the wheel nuts have loosened at any time, have checked and torque to proper limits immediately.

If you suspect or notice wheel stud bolts are cracked or broken, they must be replaced, along with adjacent bolts that have probably also been weakened due to additional stress placed on them.

You, as the owner of the motorhome, need to make frequent inspections of the wheels and tires, looking for signs of wear or damage. You also need to avoid abusive driving habits, such as hitting curbs or chuck holes at high speeds which can damage tires and wheel components.

NOTE: The proper way of tightening wheel nuts is with a torque wrench, not with an impact wrench or by hand. Because of the importance of having the proper torque on wheel nuts, you should have wheels mounted by authorized personnel with the proper tools.

WHEEL AND TIRE BALANCING

Handling and tire wear can be enhanced by maintaining the proper balance of wheel and tire assemblies. It is important to have wheel and tire balancing checked on a regular basis. If you experience handling problems or abnormal tire wear, it may be easily corrected by proper balance. Specialized equipment is required to effect proper balancing, and the motorhome should be taken to a shop that is qualified to perform this service.

FRONT SUSPENSION AND ALIGNMENT

Maintaining proper alignment will result in increased steering ease and stability of the motorhome. Because of this, tires and suspension will last longer and fuel economy will be increased. Many times, problems with tires can be traced back to poor maintenance which will cause mechanical failures in the motorhome. This is why it is important to follow a regular scheduled maintenance plan that can identify and correct mechanical problems before they cause greater and increasingly more expensive mechanical failures. Safety is also enhanced by a properly maintained vehicle.

The term alignment refers to both the adjustment angles on the steering axle and suspension and the tracking of the rear axle. Many factors are considered when establishing proper alignment. Steering components, suspension, wheel bearings, and even proper loading all effect alignment.

Any time you notice unusual tire wear or experience poor handling of the motorhome, it would be wise to suspect improper alignment along with the various other possibilities that might be causing the problem (check the chassis owner's manual). Always have the alignment of the motorhome checked and adjusted by a qualified shop with the proper equipment to handle heavy vehicles.

NOTE: The front end alignment of your motorhome has been set by the motorhome chassis and body builder to the specification for front and rear GVW of your motorhome. However, since alignment is affected by not only how much weight you add to the motorhome in the way of cargo and how much water/LP, etc. that you carry and how you disperse the cargo, we advise you to have the motorhome alignment checked in the loaded condition (the way you would travel down the road). Not having the alignment set in the loaded condition could result in abnormal tire wear.

POWER PLANT AND DRIVE TRAIN

Full operating and service information may be obtained by consulting the engine and drive train operating and service manuals provided by the chassis manufacturer. For maximum engine efficiency and long service life, always follow recommendations, as outlined by the chassis manufacturer. Regular visual inspections can help detect minor adjustments and needed maintenance. All other components of chassis should be inspected regularly per schedules set by chassis manufacturer.

ENGINE COOLING SYSTEM



WARNING: Ethylene glycol is a petroleum derivative which can ignite if exposed to high temperature, such as occurs on an exhaust manifold. The possibility of ethylene glycol igniting is increased if it is not diluted with water. It is important to properly dilute antifreeze with the proper mixture of water. Make sure to discuss the coolant needs of your vehicle with your chassis engine service representative.

The engine cooling system requires regular, periodic service to operate at maximum efficiency. The condition of the engine coolant, hoses, and clamps should be checked annually. Make sure to follow the cooling system recommendations as outlined in your chassis engine owner's manual. If you notice, or suspect cooling system problems, make sure it receives immediate attention. Proper and safe operation of the chassis engine cooling system and other chassis functions depends on maintaining the vehicle per the instructions and schedules published by the chassis and engine manufacturers.

PROPER LOADING AND WEIGHT DISTRIBUTION

Your RV has been designed to carry loads within specified limits. Exceeding these limits will greatly affect the handling of the RV. These limitations are defined in three ways:

1. Gross Vehicle Weight Rating (GVWR) – Maximum permissible weight of this motorhome. The GVWR is equal to or greater than the sum of the Unloaded Vehicle Weight plus the Net Carrying Capacity.
2. Gross Axle Weight Rating (GAWR) - Maximum load carried by an axle: sum of rating may be more than GVWR to allow for load variations.
3. Gross Combined Weight Rating (GCWR) - Means the maximum allowable loaded weight of this motorhome with its towed trailer or towed vehicle.

Check weight ratings of your RV on the serial number identification tag.

Additional terms used when discussing weight and distribution include:

1. Gross Vehicle Weight (GVW)- The total loaded weight of the RV
2. Gross Axle Weight (GAW)- The total axle weight under any given load condition
3. Unloaded Vehicle Weight (UVW) - Weight of this motorhome as built at the factory with full fuel, engine oil, and coolants. The UVW does not include cargo, fresh water, LP gas, occupants, or dealer installed accessories.
4. Net Carrying Capacities (NCC)- Maximum weight of all occupants including the driver, personal belongings, food, fresh water, LP gas, tools, tongue weight of towed vehicle, dealer installed accessories, etc. , that can be carried by this motorhome. (NCC is equal to or less than GVWR minus UVW).

NOTE: When establishing the NCC, weigh the motorhome with the fresh water tank and the LP tank. Do not allow anyone to be in the motorhome when establishing this rating. To determine the allowable tow rate subtract the GVWR from the NCC.

DO NOT assume that you can fill all tanks and storage areas and be within the GVWR. Weights of stored items and passengers will vary greatly and will affect total weight of your RV.

NOTE: For calculation purposes fresh water weighs 8.33 pounds per gallon. LP gas weighs 4.5 pounds per gallon.

WEIGHT INFORMATION LABEL

A WEIGHT INFORMATION LABEL, similar to the following diagram, has been placed inside a wardrobe closet in your motorhome. These weights are based on calculations involving similar vehicles as yours and will not be the exact weight of your vehicle. You will need to weigh your vehicle to determine the exact weights and carrying capacities of your vehicle.

DO NOT OVERLOAD YOUR MOTORHOME

| | |
|-----------------|------------|
| SERIAL NO _____ | GVWR _____ |
| VIN _____ | UVW _____ |
| MODEL _____ | NCC _____ |
| | GCWR _____ |

GVWR (Gross Vehicle Weight Rating) means the maximum permissible weight of this motorhome. The GVWR should not exceed the sum of the Unloaded Vehicle Weight plus the Net Carrying Capacity. (GVWR equal to or less than UVW + NCC)

UVW (Unloaded Vehicle Weight) means the weight of this motorhome as built at the factory with full fuel, engine oil, and coolants. The UVW does not include cargo, fresh water, LP gas, occupants, or dealer installed accessories.

NCC (Net Carrying Capacity) means the maximum weight of all passengers, including the driver, personal belongings, food, fresh water, LP gas, tools, tongue weight of towed vehicle, dealer installed accessories, etc., that can be carried by this motorhome. (GVWR minus UVW).

GCWR (Gross Combination Weight Rating) means the value specified by the motorhome manufacturer as the maximum allowable loaded weight of this motorhome with its towed trailer or towed vehicle.

This motorhome is capable of carrying up to _____ gallons of fresh water (including water heater) for a total of _____ pounds. In planning how you use your Net Carrying Capacity, other load weights may be substituted for equivalent fresh water weight. Weight of fresh water is 8.33 lbs/gal.

Each motorhome has been designed with ample room and capacities for several different types of usages, from extended trips for two people to short trips with several people. The large storage compartments and abundant cabinet spaces in the interior of the motorhome offer many benefits to the user of the motorhome. The user also bears the responsibility in selecting the proper combination of cargo, fluids, towed vehicles and passengers to insure the vehicle weight limits are not exceeded.

CONSULT OWNER'S MANUAL FOR SPECIFIC WEIGHING INSTRUCTIONS AND TOWING GUIDELINES

COMPUTING YOUR LOAD AND LOAD DISTRIBUTION

Always give careful consideration when loading your RV so that items will be evenly distributed. Not only will the RV handle and ride better, but you will have reduced tire wear and increased fuel economy. This will insure that you have not overloaded one side or the other, affecting RV handling. DO NOT store heavy items near the front or rear ends of the RV.

It is recommended to empty the waste holding tanks before leaving on a trip, and as often as possible when traveling, to help keep weight reduced. Try to carry only as much fresh water as you will use when traveling.

It is also important to keep in mind when traveling, that all items stored inside and outside the RV are secure, and all drawers and doors are secure. DO NOT add any type of rack or frame to any RV frame or chassis part. The alteration to length and/or weight distribution may result in unstable handling, be a safety hazard, or could damage the RV components. In any case, the RV warranty may be affected.

In order to properly compute your load and load distribution, you must know both actual scale weights, and the GAWR and GVWR found on the Federal Certification Label on the motorhome. Weigh with all passengers, equipment, luggage, and fluids on board as you plan to travel with.

To weigh your motorhome properly, use the following procedure:

1. All passengers must be in their seats and the vehicle level. Place the front axle only on the scale. Check the weight against the front gross axle weight rating.
2. Pull forward so that both axles are on the scale. Check the weight against the gross vehicle rating.
3. Pull forward again so that only the rear axle is on the scale. Check the weight against the rear axle weight rating.

NOTE: The vehicle must be setting on level ground when weighing the front or rear axle separately. The weight distribution will be greatly affected if this is not done and the weights will be inaccurate.

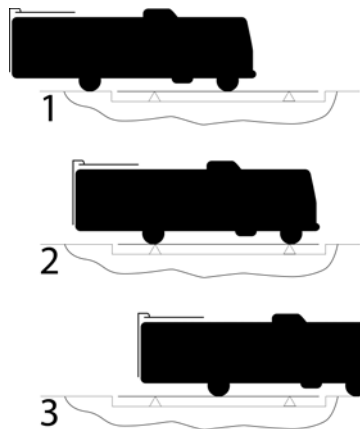

Compare scale weights with capacities as shown in the following example:

(This example is hypothetical only)

| | |
|------------------------------|------------------------------|
| GVWR | 14,500 lb. |
| GVW | <u>12,570</u> lb. from scale |
| Carrying capacity | <u>1,930</u> lb |
| Front GAWR | 5,000 lb |
| Front GAW | <u>4,000</u> lb from scale |
| Front axle carrying capacity | <u>1,000</u> lb |
| Rear GAWR | 10,000 lb |
| Rear GAW | <u>8,890</u> lb from scale |
| Rear axle carrying capacity | <u>1,110</u> lb |

DRIVING

Now that you have determined your vehicle's weight and balance you are ready to pull out on the open road.

The RV is equipped with more than adequate brakes; however, the stopping distance may be much greater than your automobile. Keep this in mind at all times and be alert to changing road conditions.

It would be helpful to take your RV out to a stadium parking lot and spend some time getting the feel of the wider and longer vehicle.

Small fluorescent sports cones, available at sporting goods and toy stores, can be used to create turns and parking spaces. Dowels with small flags can be attached to make the cones more visible in the passenger's side view mirror. Practice parallel parking, backing and turns. Afterwards, the cones can become an addition to your safety equipment.

Get a person to work with you, having them help guide you from both the passenger seat and a position outside using hand signals.

The other vehicle characteristic that needs to be taken into consideration immediately is height. Read all "clearance" signs when approaching parking garages, drive-through windows and even underpasses on older highways. Also be careful of overhanging trees. Always use caution and when in doubt get out and look. Don't forget any added equipment that may protrude higher than the standard factory height.

Passing and pulling out into traffic in your RV is going to be different than when driving your everyday vehicle. Generally speaking, it will take more time, thus, more distance to pass when it necessitates driving in an on-coming lane of traffic. It will take more time to clear an intersection from a dead stop. Allow more distance between cars.

Because your RV is longer and wider than your other vehicles, a bit more attention must be paid to cornering. Practicing in a stadium lot is helpful, as indicated earlier.

The main idea is to pull several feet past the apex of the corner before initiating the turn. This is to give extra room for the rear outside wheels to clear the inside curb. Instead of cutting corners, learn to use the entire roadway by bringing the vehicle closer to the center stripe of the street or road you are entering. However, do not swing "out" or over the center line of the road you are turning off. Because of the extra room your vehicle needs to clear the inside curb, you must be fully aware of the traffic that you are turning into (what becomes the oncoming traffic after you turn). Note how close the vehicles are to the center line and especially if they are over the center line and into your lane.

HILLS, DALES AND MAKING THE GRADE

Driving in hilly or mountainous terrain isn't any more difficult than driving on the flat plains of Kansas if the driver uses the vehicle properly. The main culprit of hilly or mountainous driving problems is overheating. Preventing problems is as simple as following your chassis manufacturer's driving instructions for this type of terrain. The main thing to remember is to reduce speed and drive in the appropriate gear, usually something other than drive.

TRAILER TOWING



The motorhome fully loaded and the trailer, or towed vehicle, must not exceed the motorhome chassis' Gross Combination Weight Rating (GCWR). Do not exceed the vehicle's Gross Combined Weight Rating (GCWR) or the hitch rating. The tongue weight, the weight pushing down on the hitch, must not exceed 10% of the hitch capacity. A separate functioning brake system is required for any towed vehicle or trailer weighing more than 1000 lbs (450 KG) when fully loaded.



CAUTION: Consult with your selling dealer to determine the GCWR of your vehicle. Do not assume that you can tow a vehicle which happens to be within the capacity of the hitch. It may exceed the total GCWR of the motorhome.



WARNING: The towing vehicle's braking system is rated for operating at GVWR, NOT at GCWR. A separate functioning brake system is required for any towed vehicles or trailers weighing more than 1000 lbs when fully loaded. NEVER exceed the GVWR, or the GAWR specified on the motorhome certification label. Also NEVER exceed the weight ratings of the trailer hitch installed on the motorhome. Failure to heed any part of this warning could result in loss of control of the motorhome and towed vehicle or trailer and may cause an accident and serious injury. For specific towed vehicle braking requirements, consult the chassis owners manual that comes with this vehicle.



CAUTION: Always use safety chains between your vehicle and trailer. Cross chains under the trailer tongue and allow slack for turning corners. Connect safety chains to vehicle frame or hook retainers. Never attach chains to the bumper.



CAUTION: Tow bars or car dollies generally are made to travel in a forward direction only. Most towing equipment of this type is not designed for backing. Never attempt short back up distances with a tow bar or tow dolly. Damage to the motorhome, vehicle or towing device will result.

Trailer packages that include high quality tow hitches are available as an option on Mandalay RVs. They are designed to meet Class specifications for your particular vehicle.

Mandalay accepts no responsibility for damage to the chassis and other components resulting from towing loads greater than its designated class specifications. You will also need to consider the gross combined weight rating of your motorhome before towing a trailer or car.

Towing an object such as a boat and trailer or a car behind an RV results in added driving considerations that you must contend with.

TOWING PROCEDURES



WARNING: In case the motorhome requires towing, ensure all precautions above are followed. The drive shaft must be disconnected and the mud flap may need removed. The manufacturer **WILL NOT** cover damage to the motorhome caused by a towing company.



WARNING: Never tow the motorhome at a speed greater than 50 mph. Never allow anyone to ride in the motorhome while it is being towed. Make sure to review the chassis owner's manual supplied with your unit for any additional requirements or cautions concerning the towing of the motorhome.

When your Mandalay needs towed for service it is recommended to use a lowboy/landall type of trailer. If a tow truck is used it needs to have a support arm that goes under the motorhome and secures to the front axle. Inform the tow company of the axle weights and total weight of the motorhome. Other important information is the length of the motorhome, number of passengers and mile-post location.

The towing company may need to locate the air nipple to release the air brakes (air brakes only). The air nipple is located behind the rear axle on the air dryer and should be used by towing personnel only. The towing company will also use this connection to provide supplemental air while towing the motorhome. Supplemental air is used to charge the air system while the motorhome is being towed.



If the motorhome needs to be towed:

- Secure any loose or protruding parts if the motorhome is damaged.
- Inspect the points of attachment on a disabled motorhome. If attachment points are damaged, select other attachment points at a substantial frame structural member.
- Never allow anyone to go under a motorhome while it is being lifted by towing equipment unless the disabled motorhome is adequately supported by safety stands.
- Do not tow the motorhome from the rear. Towing from the rear will severely overload the front tires and suspension possibly resulting in tire and/or front suspension failure. Rear frame extensions are not designed to support weight loads imposed by lifting the motorhome from the rear.
- If the rear wheels are disabled, place the motorhome on a flat bed trailer or use a heavy duty dolly under the rear wheels and tow the motorhome from the front.
- The drive shaft must be removed to prevent damage to the transmission. Secure the end caps to prevent losing or contaminating the needle bearings.
- The mud flap may need to be removed to prevent damage due to limited ground clearance.
- Review the chassis owner's manual for proper towing guidelines.
- The motorhome **SHOULD** be towed from the front. **NEVER** tow the motorhome from the rear.
- Use an approved tow truck normally used for towing large vehicles.
- Tow with the parking brake released and the transmission in neutral.
- Make sure the front wheels are lifted at least four inches off the ground, and that the rear of the motorhome has adequate clearance.

- It may be necessary to disconnect the drive shaft, or use a dolly under the rear wheels. If the rear wheels will not rotate, it will be necessary to place the rear wheels on a heavy duty dolly, and tow from the front. Make sure that there is nothing loose or jutting out from the motorhome which could be a safety hazard while towing.

EMERGENCY STOPPING

If an emergency ever requires you to be stopped, be sure to follow these guidelines:

1. Pull off the road as far as possible
2. Select the Neutral position on shift selector and apply the Parking Brake.
3. Turn on your hazard warning flashers
4. If traveling at night, use three red warning indicators such as flares, reflectors, or lanterns as required by the Uniform Vehicle Code and Model Traffic Ordinance as follows:
 - a. Place the first at traffic side of the vehicle, directed at the nearest approaching traffic.
 - b. Place the second 100 feet behind the RV in the center of the lane and toward approaching traffic.
 - c. Place the third 100 feet in front of the RV in the center of the lane and away from the traffic approaching from behind.
5. Always stand off the road.

NOTE: Curves and/or hills may effect the safe placement of warning indicators.

FUELING YOUR MOTORHOME

For your convenience there are two fuel fills on your motorhome. They are located on both sides of the motorhome, towards the front of the unit. This allows access into filling stations from either side of the pump.

NOTE: Always remove the fuel cap slowly and pay close attention to the fuel recommendations outlined in your chassis literature.



WARNING: Be extremely careful when fueling your motorhome. Always shut off your engine, do not smoke, or use cellular phones and shut off all pilot lights before adding fuel. Fuel spills represent a serious fire hazard, and should be cleaned up immediately. Never restart the engine, or relight pilot lights while raw fuel is present. When weather gets cold or coach has not been used for a while, a fuel anti-gel additive will be needed.

CHASSIS FUNCTIONS



DASH CONTROLS

You should thoroughly familiarize yourself with the various controls, instruments, and indicators available to you in your motorhome. Performance and safety can be enhanced by the driver who fully understands each one, and how to use them.

IMPORTANT: The chassis owner's manual furnished with your motorhome has complete information for operating and maintaining chassis functions. Make sure to read and follow all instructions in the chassis owner's manual, paying particular attention to all precautions and warnings associated with its use.

If the appearance or placement of the gauges, instruments and controls does not exactly match the illustration in your chassis owner's manual, the instructions for their use will still apply.

DASH HEATER/AIR CONDITIONER



WARNING: The air conditioning system contains refrigerant 134a under high pressure and should be serviced by qualified personnel only. Improper service methods could cause serious personal injury.

Your new motorhome has been equipped with the industry's highest performance integrated heating/air conditioning system. While this system is much more powerful than those used in passenger cars, it is, none the less, not capable of heating and cooling the entire motorhome. This system is designed to provide windshield defrost and heating and cooling for the front seat occupants only. By following the operating instructions and tips, this heater/air conditioner will provide many years of comfort and dependable service.

SYSTEM LAYOUT

The heater/air conditioner unit is located beneath the dash on the passenger side of the vehicle with heating and cooling coils located on the outside of the firewall. In most modes of operation the unit takes fresh air from outside, and heats or cools it before discharging into the vehicle. Only when operated in the **MAX A/C** mode does the system take air from inside the vehicle.

OPERATING INSTRUCTIONS

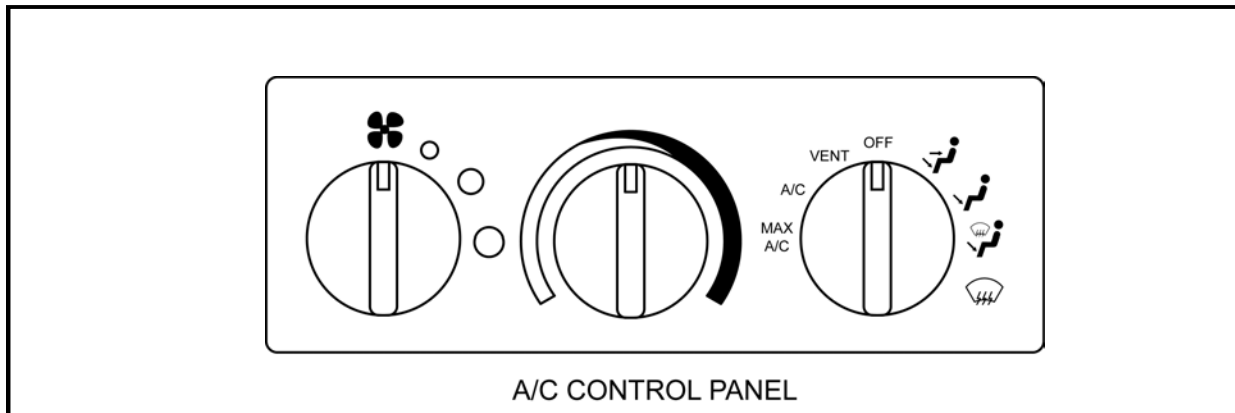

CONTROL PANEL OPERATION

The control panel enables the driver to control the temperature, volume and direction of the air discharged from the heating/air conditioning system.

BLOWER CONTROL

One of the best ways of controlling temperature is by changing the speed of the blower. The blower knob (left of center) provides 4 speeds in any mode except OFF.

TEMPERATURE CONTROL

The center knob controls the temperature of the discharge air. Turn the knob to the right (red area) for warmer air, and to the left (blue area) for cooler air.

OPERATING FEATURES





The air conditioning system is designed to operate in all modes except VENT, FLOOR and OFF. This provides significant moisture, dust and pollen removal for enhanced passenger comfort.

The A/C will not function if the outside air temperature is below approximately 40° F.

In the event control vacuum is lost, the system is designed to discharge through the defrost vents.

AIR DISTRIBUTION – MODE CONTROL

To achieve the maximum comfort in your motorhome, the air must be directed where it is needed. The mode switch (right of center) gives the driver the ability to select where the air will flow.

- MAX A/C** Air is drawn from the passenger compartment (Recirculated Air) and discharged through the dash louvers. These louvers can be adjusted for maximum comfort.
- A/C** Outside air (Fresh Air) is drawn into the system and discharged through the dash louvers. These louvers can be adjusted for maximum comfort.
- VENT** Outside air is drawn into the system and discharged through the dash louvers. For enhanced passenger comfort, upper-level ventilation air is also discharged through the defrost opening.
- OFF** The blower motor does not operate in this mode. The fresh air inlet door closes, minimizing outside air infiltration into the vehicle.
- 
 Outside air is drawn into the system and discharged through the dash louvers, floor and defrost outlets. The A/C system operates in **BI-LEVEL** mode.
- 
 Outside air is drawn into the system and discharged through the floor outlets. In some models a small amount of air is directed to the windshield for defrost. The A/C system does not operate in **FLOOR** mode.
- 
 Outside air is drawn into the system and discharged through the floor and defrost outlet. The A/C system operates in **MIX** mode to provide windshield defogging.
- 
 Outside air is drawn into the system and discharged through the defrost outlets. The A/C system operates in **DEFROST** mode to provide windshield defogging.

CARE AND SERVICE

Keep the condenser and radiator free of bugs and debris. During periods of little use, operate the A/C system monthly to keep the compressor lubricated. Periodically inspect belts and hoses for wear and proper tension.

WINTER OPERATION

The discharge air will heat up faster if the blower is operated on lower speeds, until the engine is hot. For windshield de-icing use DEFROST mode.

SUMMER OPERATION Maximum Cooling

Use MAX A/C and HI blower for quick cool down. A lower blower speed produces cooler air. Close all windows and vents to hot, humid outside air.

WARRANTY/SERVICE

If repairs are necessary during the terms of the RV warranty, please contact the nearest authorized Mandalay dealer for service. In the event repairs are necessary during transit, contact Mandalay Customer Service.

NOTE: Unauthorized repairs may void the warranty.

FAN SWITCH



WARNING: Do not remove the protective cage from the fan. Do not allow anyone to place fingers or other objects into the protective cages.

The fan switch turns the power on or off to the optional overhead defroster fans. Each fan can be operated separately with individual switches on each fan if this switch is in the ON position.

ACCESSORY SWITCH

This switch is placed in the dash as a convenience for the owner who wishes to install additional 12 volt functions to the vehicle. It is wired to the fuse block on the front firewall under the hood.

EMERGENCY START

Holding this switch down while turning the ignition switch may allow the coach battery(s) to be used to start the engine in the event the automotive battery is low or dead.

This feature is designed to be used momentarily to start the engine. DO NOT hold the switch down for extended periods of time. Overheating will occur causing serious electrical failure and damage to electrical components.

HEADLIGHT SWITCHES

The three-position headlight switch controls the instrument, parking, marker, tail and headlights. Rotating the Rheostat switch controls the brightness of the instrument lights.

WIPERS

Left and right hand wipers are activated by a single control. This control has an intermittent wiper feature. Windshield washers for both sides are activated by pressing on the center of the wiper control.

NOTE: You should check the level of the washer fluid regularly. Use a washer fluid that is intended for this purpose to clean better and offer protection from freezing. DO NOT use additives such as radiator anti-freeze in the washer fluid that might cause damage to either the washer system or the motorhome finish.

NOTE: To prevent possible damage to your windshield or wiper blades, do not operate the wipers when the windshield is dry.

GENERATOR REMOTE SWITCH AND HOUR METER

The generator remote switch and hour meter, located on the dash panel, control the remote ON/OFF operation of the generator. Make sure to read all information on generator operation elsewhere in the owner's manual.

CIGARETTE LIGHTER

To use the lighter, press in all the way and let go. It will pop out by itself when it is ready.

NOTE: Do not hold a cigarette lighter in with your hand while it is heating. If you do, it won't be able to back away from the heating element when it's ready. That can make it overheat, damaging the lighter and the heating element.

HEATED MIRROR SWITCH

This switch activates optional heaters in each of the outside mirrors that defrost them when required. Turn the heaters off when the mirrors are defrosted.

POWER MIRROR ADJUSTMENT

The power mirror functions for both left and right hand mirrors are controlled by this single switch. A center switch is used to select either the left (L) or right (R) hand mirrors. The outer control is used to control the movement of the mirror selected. Pressing on one of the four sides moves the selected mirror in the direction indicated by the arrow on that side.

Always adjust mirrors for proper vision before starting and moving the motorhome. Each side is equipped with both normal and wide angle mirrors for more complete vision.

Steering column controls and functions are also covered in the chassis owner's manual.

EXTERIOR OPERATIONS

Your new RV from Mandalay offers virtually all the comforts of home while out on the road. These systems are of the most modern design available, just as the similar systems in your home, however, the RV systems may be of different design, and construction than those found in your home. The following instructions are for items that your RV has to offer you. Some items are touched on briefly, for more detailed instructions on particular items; see the manufacturer's manual supplied with that item.

ENTRY DOOR

The entry door consists of both an exterior door and a screen door used for ventilation when the RV is parked. DO NOT attempt to drive the RV with the doors open. The doors may be damaged and it is a safety hazard.

Your entry door is equipped with a movable latch system. This is designed to keep the latch from getting into a bind, if you are parked on an uneven surface, your coach could become twisted. If this happens it is possible that your door would be stuck closed. This movable bolt will keep that from happening. It is important to always make sure that the latch is maintained and working properly. The door has 2 locking



positions; always make sure the door is completely shut before driving the motorhome. When the RV shift selector is placed in Drive or Reverse the entry door will automatically engage the air lock mechanism. The lock is a safety feature added to the door to improve the seal around the door. To disengage the lock, place the shift selector in Neutral and apply the parking brake.

When driving, it is a good idea to keep the door locked to prevent uninvited entrance from the outside when stopped. Two types of locks are provided with the outer door. The handle lock for normal security and a dead bolt lock for additional security.

The screen door can be attached to the outer door. A sliding panel on the screen door permits access to the handle on the outer door to prevent unnecessary handling of both doors. Separate keys are provided for both types of door locks. It is a good idea to keep a record of the key numbers in a safe place, should it become necessary to have duplicates made.

POWER STEP



WARNING: Make sure before exiting the vehicle, that the step is activated and/or extended. Because of the height of the RV, you may accidentally slip or fall if attempting to exit without use of the step. If the step will not operate, use extra care when exiting. Never activate the step when someone is using it, and be sure to keep hands, feet, children, and pets away from the mechanism when activated.

When the power step is activated, it extends and retracts automatically when the door is opened or closed. There are two ways to control the operation of the step:

Switch panel— Power to the step, provided by the chassis batteries, may be turned on and off with the rocker switch located just inside the door. When on, the step will extend whenever the door is opened, and retract when the door is closed. The step may be kept in the extended position by turning the switch off after the step is lowered. To maintain your battery life this switch should be turned off while in storage.

Ignition switch— Whenever the ignition switch is turned on, the power step is automatically activated. This will prevent accidentally driving with the step lowered, since it will retract with the door closed.

STORAGE

Your RV is equipped with numerous outside storage compartments. Each door can be locked for security. These doors are equipped with gas struts to hold the door open, if these become weak, contact your dealer for proper replacement. If the wrong size strut is used it could cause damage to the door. On compartments under the slide outs there are adjustable brackets, these will allow the door to open at two different heights. One position is set up to open the door at a 90° level from the closed position, and the other setting is to open the door more than 90° from the doors closed position. To adjust the gas struts; loosen the strut anchor nut, located on the strut bracket, and position the strut in the desired bracket inlet. Tighten the strut anchor nut. Repeat procedure for the other gas strut as well. Do not close the compartment door until both gas struts are secure and in the same inlet setting.

Do not overload outside storage compartments with heavy densely packed items. Remember that any weight added to the RV effects the overall vehicle weight. Also remember to check side to side weights, since putting an extremely heavy item on one side or the other will effect proper load distribution.

Keep any emergency items stored in outside storage compartments easily available, where they can be reached without unloading the entire contents of the compartments.

NOTE: Make sure that all compartment doors are closed, latched, and contents secure before starting and moving the RV.

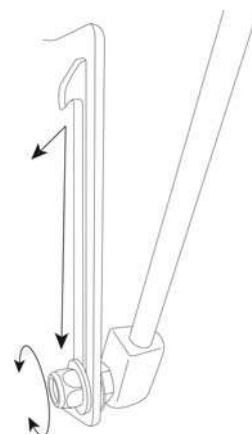

WARNING: When closing the storage doors make sure that hands and fingers are clear of hinges and openings

LADDER AND ROOFTOP STORAGE

The ladder located on the rear of the RV is used to gain access to the roof to perform maintenance on the roof mounted items. Make sure before climbing the ladder, that your shoes are not slippery and that there is no ice or other slippery substance on the ladder.



WARNING: DO NOT climb on or walk on roof when it is wet. The roof could be very slippery, and cause you to slip and fall causing serious injury.

AWNINGS

The manual awnings that are located on some windows around the RV operate by pulling down on the awning strap, using the awning rod, to the full extended position. Underneath the window, located on the sidewall, is a hook used to hold the awning strap while in the open position.

Awnings located on the top of the slide-outs will open and close automatically with the movement of the slide-out housing.

If your RV comes equipped with automatic awnings, there are a few important things to remember. Read all instructions supplied by the awning manufacturer. The control buttons are located just inside the entry door. To extend and retract the awning all you have to do is push a button. The main purpose of the awning is to protect you from the sun, not from rain, wind, or snow. If threatening weather approaches, you need to retract all awnings. If the awnings are rolled up wet, open them back up as soon as possible to allow them to dry.

GENERATOR SLIDE

Your generator is located at the front of your RV. To gain access to the generator there is an automatic slide that will extend out for access and retract for storage. The switch for this is located on the dash. Before operating this feature, make sure that you have plenty of room in front of your RV to allow for the slide tray to extend; otherwise it could cause damage to the slide or fiberglass cover.



IMPORTANT: MAKE SURE TO READ AND UNDERSTAND THE GENERATOR OWNER'S MANUAL BEFORE OPERATING THE GENERATOR. Observe all warnings and cautions, as well as all recommended maintenance schedules and procedures. The fuel supply for the generator comes from your main fuel tank for your RV.

There are two locations from which you can start your generator. One is at the control panel on the generator itself, while the other is located on the dash in the driver cockpit area.

The generator comes with a standard fuel safety feature that will engage when the RV fuel tank reaches approximately $\frac{1}{4}$ of a tank. When engaged, the generator will not run until the fuel tank has been filled. After filling the tank the safety feature automatically disengages allowing normal operation of the generator.

GENERATOR SAFETY

There are several warnings and precautions that should be observed when using the generator. MAKE SURE to read all warnings and cautions in the generator operator's manual before operating or attempting repairs on the generator.

1. Never store anything in the generator compartment. Always keep compartment clean and dry.
2. Review the safety precautions for fuel and exhaust fumes elsewhere in this manual.
3. DO NOT operate the generator while sleeping. You would not be aware of exhaust entering the RV, or alert to symptoms of carbon monoxide poisoning.
4. DO NOT operate the generator when the RV is parked in high grass or brush. Heat from the exhaust could cause a fire in dry conditions.
5. Never operate your chassis or generator engine, or the engine of any vehicle, longer than necessary when the vehicle is parked.
6. DO NOT simultaneously operate generator and a ventilator which could result in the entry of exhaust gas. When exhaust ventilators are used, we recommend that a window on the opposite side of the unit "up wind" of exhaust gases be opened to provide cross ventilation.
7. When parked, orient the vehicle so that the wind will carry the exhaust away from the vehicle. DO NOT open nearby windows, ventilators, or doors into the passenger compartment, particularly those which can be "down wind", even part of the time.
8. DO NOT operate the generator when parked, so that vegetation, snow, buildings, vehicles, or any other object could deflect the exhaust under or into the vehicle.
9. DO NOT touch the generator when running, or immediately after shutting off. Heat from the generator can cause burns. Allow the generator to cool before attempting maintenance or service.

RALLY KIT COMPARTMENT

Your rally kit compartment has many different functions that will be used during your travels. For your convenience we have located most of the external accessories in one easy to use compartment. In this compartment you will find your power cord, water fill, termination valves, telephone and cable hook up, low point drain, exterior shower, and other personal hygiene items.

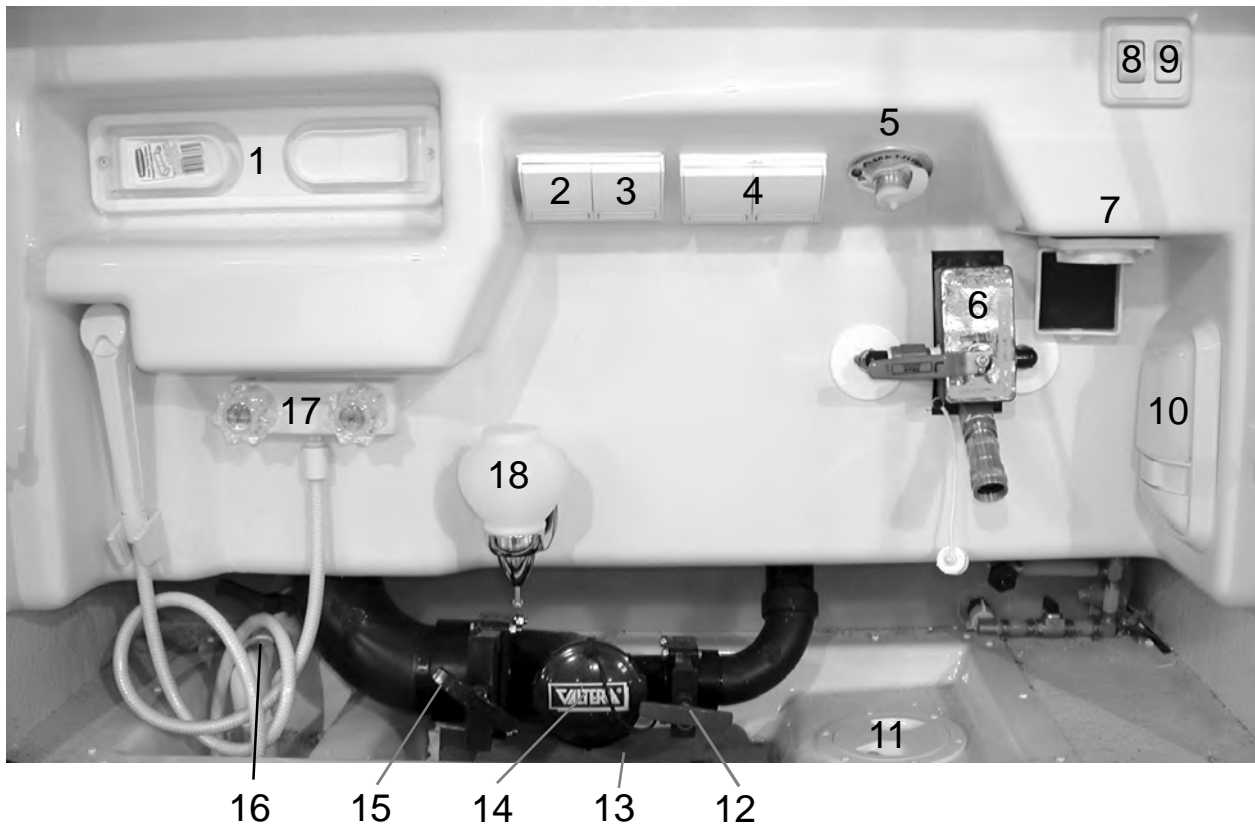

1. Paper Towel Holder - Holds paper towel rolls to assist with cleanup.
2. Coax Cable Hook-up - When available, provides cable and/or satellite to interior of RV.
3. Phone Jack Hook-up - Supplies phone service to RV interior when available.
4. 110 volt Outlets
5. No Fuss Flush - Attach water hose to fitting to assist with black tank drainage.
6. City/Fresh Tank Water Fill Valve - Two way directional valve which controls city water flow between filling the fresh water tank and direct interior usage.
7. 50 amp Shore Cord Harness
8. Water Pump Switch - Provides power to water pump.
9. Baggage Compartment Light Switch - Provides power to 12 volt compartment light.

10. 12 volt Compartment Light - Manual ON/OFF light that provides light to service bay.
11. 50 Amp Shore Cord Access Hatch - Allows service bay door to completely shut when connected to 50 amp service.
12. Gray Tank Dump Valve - Pull T-handle to dump waste water from the gray tank.
13. Sewer Hose access Hatch - When dumping, run sewer hose through access hatch.
14. Sewer Hose Hook-up - Attach sewer hose to this fitting to assist with drainage.
15. Black Tank Dump Valve - Pull T-handle out to dump solid waste from the black tank.
16. Fresh Tank Drain Valve - Turn handle to the left to drain excess water from the fresh tank.
17. Exterior Shower - Provides hot or cold water to the exterior of the RV.
18. Hand Soap Dispenser - For easy clean-up convenience fill soap dispenser with hand soap for use after handling sewer hose and drain caps.

WATER AND DRAINAGE

Mandalay

GENERAL INFORMATION

Your new RV plumbing system has the dual ability to be self-contained with onboard storage, or use facilities provided by an external pressurized source. In either case, the components of the system operate like those in your home. Components of the plumbing system consist of strong, lightweight, corrosion-resistance materials that provide long life, and easy cleaning. By following the instructions outlined here, you can expect efficient operation with a minimum of maintenance.

FRESH WATER SYSTEM

Fresh water is provided from an external pressurized source, or from the fresh water storage tank.

EXTERNAL HOOKUP

Water provided from outside the RV is pressurized by the system from which it is delivered. When you connect the RV to an outside source, the fresh water tank and water pump are kept separate from the remainder of the system by in-line check valves.

To attach the RV to an outside source of water:

1. Run a clean water hose thru the porthole in the bottom of the rally kit compartment.
2. Attach one end to water supply and the other end into the city water connection inside the rally kit
3. Turn lever on the bypass valve to the city water position
4. Turn the outside source on. Open various faucets in the RV gradually to clear the air from the lines. Close the faucets when the water flows freely.

NOTE: Do not turn the water pump on when using water from an external supply.

FRESH WATER TANK

When an outside source of water is unavailable, water can be drawn from the fresh water storage tank for use in the RV. To fill fresh water tank proceed as follows.

1. Attach a clean water hose to the inlet inside the rally kit area, and an outside water supply.
2. Turn the lever on the bypass valve to the fresh tank position.
3. Begin filling your tank.
4. When tank is full turn off water supply.



WARNING: Never leave your hose unattended while you are filling your fresh tank.

NOTE: There is an overflow line that will drain unto the ground if you get the tank too full. Always fill the tank with clean drinkable water from a known safe source. Also always fill the system with a hose that you know is clean, and is used only for this purpose.

WATER PUMP

The self contained water system is a demand only system. This means the system must be pressurized. A self-priming 12volt DC pump is provided to handle this function. This means that the water pump will run whenever there is a need for water. If the pump runs when all faucets are closed, there may be a leak in the system. If this happens turn the pump off, and have the systems checked by a qualified service center.

When initially starting up the self contained water system, follow this procedure:

1. Make sure the tank is filled with water
2. Open all the faucets in the RV, both hot and cold.
3. Place the pump control switch to the ON position.
4. Allow time for the hot water tank to fill. Shut off each faucet as the flow becomes steady and free of air. When the last faucet is shut off, the pump should also shut off
5. The system is now ready for use.

NOTE: When filling the system, you may want to add additional water to the tank to replace the water used when filling the hot water tank and water lines.

When traveling, you may want to drain the tank, or keep the quantity of water to a minimum. This reduces the total weight of the RV for travel. Make sure when draining the tank, that the water pump has been turned off. The fresh water tank valve is located in the rally kit area in the bottom by the fresh water tank. Water in the tank can be drained by turning the drain cock to the open position. When trying to drain entire onboard fresh water system, make sure to open faucets, water heater drain, and system low point drains to remove all fresh water from the system. When systems is finished draining, be sure to close all drains before filling again.

SANITIZING THE FRESH WATER SYSTEM

Sanitize the system before initial use, after extended periods of non-use, at least once a year during continuous use, and whenever there is suspicion that the system has been contaminated.

To sanitize the system, use the following procedure:

1. Prepare a chlorine solution using a gallon of water and ¼ cup of liquid household bleach (5 % sodium hypo chlorinate solution). Use 1 gallon of solution for each 15 gallons of tank capacity.
2. With tank empty, and all faucets and drains closed, pour the solution into the fresh water tank.
3. Complete filling the tank with water.
4. Switch on the water pump. Open all faucets one at a time until all air is purged, and the water flows freely.
5. Again add water to the tank until it is full.
6. Allow the system to stand undisturbed for a few hours (at least three).
7. Drain the system by opening all faucets, and the fresh water tank drain valve, while flushing the system with water of drinking quality.
8. Continue flushing the system, allowing the water to flow for several minutes.
9. Close the tank valve and faucets. Refill the system with water of known drinking quality.

NOTE: A slight chlorine taste may linger. If this is objectionable, mix a solution of 1 quart vinegar to 5 gallons of water and add to the tank. Let stand for 3 hours and then flush the system again.

MONITOR PANEL

The monitor panel allows you to quickly check the levels in the fresh water and waste water tanks. Electrical sensors at various points on the tanks send signals to the monitor panel. To check fluid levels, press and hold the test switch designated for the tanks, and read the level indicators on the panel. The indicator is proportioned in quarters with each light being lit up to the level that the tank contains.

Sometimes, residue on the sides of a tank, or water with a low mineral content will give a false reading. Check the levels occasionally when you are sure of a tank's contents to double check the accuracy of the monitor panel.

LIGHT INDICATORS:

Red - Full

Yellow - ½ Full

Green - Empty

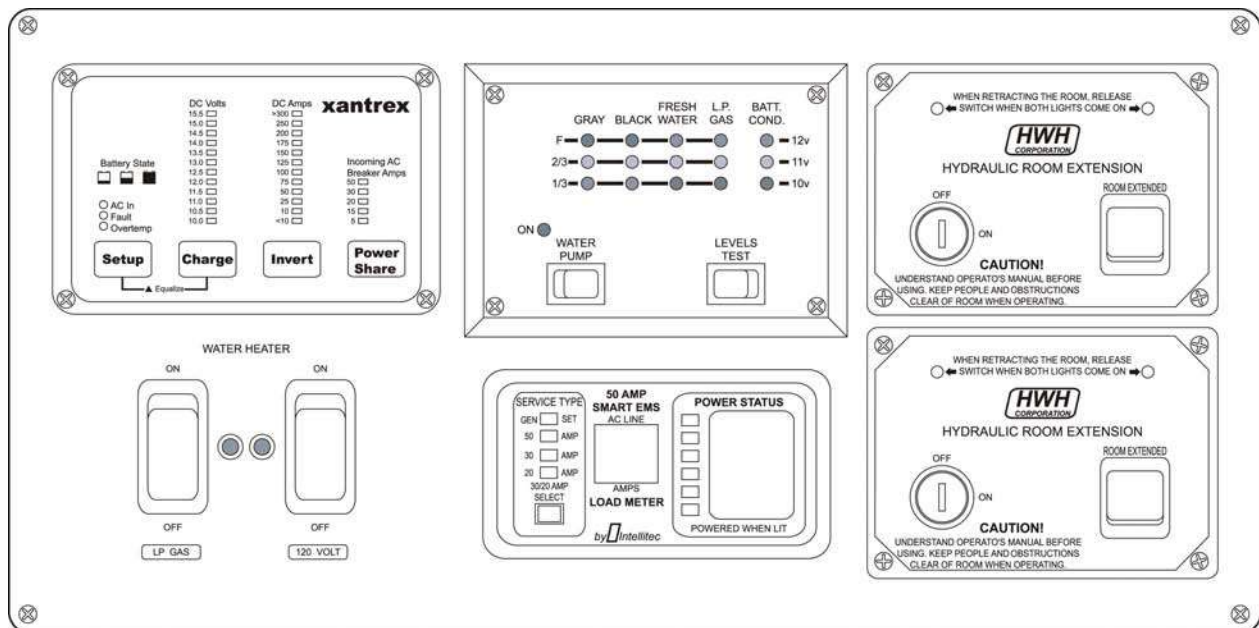

Common Field Problems

1. Inaccurate holding tank level readings
2. Some or all holding tank level lights not coming on
3. Some or all holding tank level lights continuously on
4. LP gas levels not reading properly

Inaccurate Holding Tank Level Readings

The accuracy of two wire holding tank monitoring systems can be adversely affected by dirty tanks, unusual mineral content in the water, or improper holding tank probe location. These conditions can cause the monitoring system to have oversensitive (read higher than actual level) or under sensitive (read lower than actual level) readings.

Oversensitive readings: Oversensitive readings can occur as a result of scum buildup on the tank walls, abnormally high mineral content in the water, or incorrectly located holding tank probes. In these situations, the monitoring system indicates higher levels than are actually present in the holding tank. Certain cleaning products and food by-products can build up on the inside walls of the holding tanks, producing a layer of scum that can cause the monitoring system to read higher than the actual level. To correct this problem, the holding tanks should be cleaned periodically (consult dealer for cleaning instructions). If the problem persists after cleaning the holding tank, the ground probe can be moved farther away from the other tank probes. The increased distance between the ground probe and the other probes will decrease the sensitivity of the monitoring systems.

Under sensitive readings: Under sensitive readings can occur if the mineral content of the water is abnormally low or if the holding tank probes are located incorrectly. In this case, the monitoring system indicates lower levels than are actually present in the holding tank. This problem can be corrected by moving the ground probe closer to the other probes. Moving the ground probe closer increases the sensitivity of the monitoring system.

The Ventline Adjustaboard™: In response to requests from the field for a means to adjust monitor sensitivity without relocating holding tank probes, Ventline has developed the Ventline Adjustaboard™ (patent pending). This adjustable circuit board allows for field adjustments to monitor sensitivity. As tank conditions or water mineral content changes, the monitor circuitry may be made more or less sensitive as required.

WASTE WATER SYSTEM

The waste water system in your RV can be described as two separate systems. A gray water system that consist of the drain lines and holding tank for waste water from the sink and tub, and a black water system which includes the holding tank and drain for toilet waste. In some cases the bathroom lavatory may drain into the black tank. Each system is self contained, and allows disposal of waste at designated dump stations at your convenience.

Components of the gray water system have drain traps, and both tanks are vented to equalize air pressure and disperse odors caused by drain water and wastes outside. Sometimes, the rocking movement of the RV while driving may empty the drain traps of their water, and allow the odors of the gray water tank to come into the coach. Residue in the drain water lines can also produce odors. To combat gray water holding tank odors, an approved deodorizing agent should be used. An agent that dissolves grease and fats and contains a detergent will help keep tank drain lines clean and free-flowing.

HOLDING TANKS

Both holding tanks are located under the bathroom area. The drain valves are located in the rally kit compartment on the driver side of the RV.

Each tank has a separate drain line and dump valve, which permits dumping tanks individually or together. Each tank should be emptied often at a dump station designated for this purpose. Most national, state, and private campgrounds have dumping facilities. Many have hookups on the campsite, while some have portable dump collectors. Many service stations, particularly along interstate highways, also have these facilities. Many campground directories list dumping station locations across the nation.

If possible, dump holding tanks before a trip, to reduce the gross weight of the vehicle. Enough water should be kept in the black water tank to cover the bottom, to prevent hardening of any residue that may remain.

Do not dump black water tank until it reaches $\frac{3}{4}$ full. This practice makes sure that enough water is in the tank to flush all waste into sewer lines. If necessary, fill tank to the $\frac{3}{4}$ mark with additional water before draining.

Never put anything into the holding tanks other than normal drain water, waste, and biodegradable products. Paper wrappers, gum, cigarettes, etc., no matter how small they might be, should never be placed into either the gray or black tanks.

NOTE: It is important to note that harmful and toxic materials can accumulate if the holding tanks are not regularly drained and thoroughly rinsed. It is also important to use holding tank deodorizing and cleaning agents in the waste water tanks to reduce odors and keep the lines open and free-flowing.

TO EMPTY THE HOLDING TANKS:

1. Remove the sewer drain hose from its storage compartment inside of the rally kit compartment.
2. Remove the cap from the vehicle sewage drain, and connect the drain hose to it.
3. Attach the other end of the flexible drain line to the dump station inlet. Make sure both ends of the flexible drain lines are securely attached.
4. Drain the black tank first, by pulling the termination valve handle toward you. Make sure to allow sufficient time for the tank to completely drain, and then rinse the tank with several gallons of water by flushing the stool. Close the valve on the stool and let it fill before releasing the tank. This creates additional force to flush the tank more completely.
5. Drain the gray water tank by pulling the termination valve handle toward you. Draining the gray water tank last, with its soapy water helps to further rinse the drain and flexible hose.
6. When tanks are emptied, close termination valves by pushing handles back to the closed position.
7. Remove flexible drain hose and wash it thoroughly with clean water. Remove the other end from the dump station inlet, and replace it in the storage compartment. Secure the sewer hose storage cover, and replace the caps on both the RV outlet and the dump station inlet.

The following guidelines will help to ensure trouble free operation:

1. Never put anything in the black water tank other than toilet paper specifically for RV systems.
2. Do not put automotive antifreeze, household toilet cleaners or drain cleaners, or any solid material into the waste water system.
3. Always use chemicals in the black water system that are made especially for this purpose.
4. When cleaning components of the waste water system, use cleaners made for RV systems.
5. Always keep the drain cap in place, and termination valves closed.
6. After every third time the holding tanks are emptied, fill and flush both tanks with clean fresh water a couple of times to keep them clear and clean.

NOTE: If connecting to a campsite sewer inlet, DO NOT open termination valves until tanks are $\frac{3}{4}$ full. DO NOT keep black water valve open while parked. Wastes are NOT flushed directly into the sewer system. Only liquid waste is drained, therefore, water must accumulate, and chemicals in tank need time to break down solids before they can be released. If draining gray water tank directly into sewer inlet while parked, make sure to close termination valve for a period of time before leaving, allow some water to accumulate in tank to use for flushing drain line and flexible hose.

NOTE: Always remember to clean up the dumpsite before leaving. NEVER empty your holding tanks directly on the ground, a roadway, river or stream.

DO NOT POLLUTE.

FAUCETS

The faucets in your recreational vehicle have been designed to be economically practical faucets that can be both beautiful and durable. The one-piece plated faucet shield is put through extensive treatments to produce a surface finish which will maintain its lustrous beauty throughout many years of use.

The patented design eliminates washer wear – the common cause of leaking. Should your faucet develop a leak it is most likely caused by debris in the water line causing improper seating of the stem tip; or as a result of the handle stop being misaligned.

Refer to the faucet owner's manual supplied with your recreational vehicle for specific maintenance and service instructions and a phone number for service.

TOILET

The Thetford toilet installed in your recreational vehicle is connected to the pressurized fresh water system. There are two flush modes available, controlled by the mode selector switch located at the back of the toilet. Up is user control/water saver mode and down is residential mode. For residential mode touch the large button once and walk away. For user control mode hold down large button for as long as you'd like to flush. Unnecessary frequent flushing of the stool will quickly deplete your fresh water supply and fill your holding tank. If the black water tank becomes full, you will no longer be able to flush the stool until the tank can be drained.

Follow the toilet manufacturer's recommendations supplied in back of this book.

WATER SYSTEM WINTERIZATION

If you intend to store your RV through periods of subfreezing weather in an unheated environment, it will be necessary to winterize the water system. Damage to water system components will result if proper winterization steps are not taken.

1. Level the unit for good system drainage.
2. Drain the waste water tanks as previously outlined.
3. Turn the water pump switch off.
4. Open all faucets, and the water heater drain.
5. Open low point drains on the water lines.
6. Drain the fresh water tank.
7. Blow the water lines out using compressed air (through the city water hook up not to exceed 60 PSI).
8. When all lines are drained, close water tank valve, water heater drain, and low point drains on water lines.
9. Fill the fresh water tank with a non-toxic antifreeze solution per the product directions.
10. Turn on the water pump, and allow the winterizing solution to circulate and fill the system.
11. Close each faucet as solution flows freely from it. This also includes the water line to toilet.
12. Turn off the water pump.

Before using the system again in warmer weather, completely flush the systems with water, flush the toilet, and sanitize the entire fresh water system. When using the RV during cold weather, and water in a tank or drain line should happen to freeze, you should take immediate steps to thaw it before damage to the system occurs. DO NOT continue to use the water system components if such a condition exists. If damage has occurred, make sure to have it repaired before using again.

WATER SYSTEM, MAINTENANCE & TROUBLESHOOTING

As with any mechanical system, your plumbing is subject to the development of problems. Most of these problems can be greatly reduced if not altogether eliminated by following a schedule of planned inspections and maintenance. Neglect of proper maintenance procedures is the usual cause of most water system problems.

Road vibrations and shocks, as well as excessive pressure from some city water sources are the main physical causes of water system damage. It is important to inspect all plumbing joints and fittings often for cracks and leaks. Water leaking from a plumbing joint can cause considerable damage if left unchecked.

A leak in the fresh water system should be suspected whenever the pump is running and all faucets and valves are closed. When the leaking fitting has been identified, attempt to stop the leak by tightening. DO NOT over tighten. Plastic fittings rarely need to be tightened with a wrench. If these fittings leak after being tightened by hand, disconnect the fitting and check for dirt, scale, or other foreign substance which may be causing the leak. Clean the fitting thoroughly and reinstall. If leaking persists, shut off the water supply until the fitting can be properly replaced. Check with your dealer for correct method of replacement, and replacement parts.

Proper winterization procedures of plumbing systems will normally be all that is necessary to prevent the damage caused by freezing. Freezing damage can harm any component of the system, including the water tanks, toilet, pump, and all piping. Be sure to follow the winterization procedures outlined in this manual. Also be sure to discuss any additional precautions that should be taken to winterize your water systems with your dealer. Local climates vary; and winter maintenance needs may be affected.

Be sure to read the literature supplied with plumbing components, such as the pump, for troubleshooting tips. Also remember that it is possible for an electrical problem to cause water system problems. Lack of power to the pump can be caused by a variety of reasons. If you are unsure of how to locate and/or repair a plumbing problem, contact your dealer.

ELECTRICAL SYSTEM

GENERAL INFORMATION

The electrical power supply provided for the RV is a dual system, operating with 110 volt AC and/or 12 volt DC.

The 110 volt power may be provided by either connecting the RV to an outside power source when parked, or by use of a RV generator. When the 110 volt system is operational, power also passes through a system inverter, allowing the full use of all 12 volt functions in the RV.

110 volt appliances in the RV include the refrigerator, ice maker, air conditioning, TV & VCR, microwave oven, inverter, washer/dryer, hot water heater, and some lights. The refrigerator and water heater also have the option to run on LP gas when 110 volt is not available. All other lights and functions are supplied with 12 volt power.

When it is not possible to access 110 volt power, the 12 volt system functions can be supplied by the coach batteries. The chassis battery is protected by a battery isolator controller to prevent discharge from excessive electrical consumption when motorhome is not running. The coach batteries are recharged by the power inverter when the RV is attached to an outside 110 volt power source, or by the generator when it is running, and by the chassis alternator when the chassis engine is running.

CONNECTING TO AN OUTSIDE POWER SOURCE

A 50 amp shoreline power cord is provided to attach the RV to a grounded power source. The electric utility service connection is located on the driver's side of the RV in the rally kit compartment. There is a porthole in the bottom of the compartment to allow the power cord to be hooked up and the door to be closed. Never use a two wire extension cord, a cheater adapter with the ground pin removed, or put a lower amperage plug on your power cord in place of the molded plug. It would be a wise idea to carry a voltage meter with you to insure the power source is putting out the proper voltage and that it is properly grounded before plugging your RV into it.



WARNING: Connecting power cord to a non-grounded or improperly grounded power source can result in a dangerous and possibly fatal electric shock. Because of the potential danger in failing to heed this warning, the RV manufacturer cannot be responsible should damage, injury, or death result from failure to connect the power cord to a properly grounded power source.



CAUTION: If shore power service is limited to 15 or 20 Amps, use of light duty extension cords and electrical adapters will create a voltage loss through the cord and at each electrical connection. Line voltage loss and the resistance at each electrical connection can be a hazardous combination. Damage to sensitive electronic equipment may result!

CIRCUIT BREAKERS

The 110 volt system is protected by circuit breakers which automatically shut the circuit off if the circuit load is too heavy, or a short circuit occurs. If a circuit breaker has been tripped, do not reset the breaker until the cause of the problem is identified and corrected.

The generator also has one or two circuit breakers, and a DC fuse on the generator control panel. If an interruption in generator operations occurs, check to see if any of these have been tripped. Consult the manuals provided with the generator before attempting maintenance on the generator.

NOTE: Some electrical appliances may have their own circuit breakers. If there is an interruption in electrical service of an appliance, consult the manual for that appliance to determine what action to take.

GROUND FAULT CIRCUIT INTERRUPTER

The 110 volt outlet in the bath is equipped with a protective circuit interrupter. The ground fault circuit interrupter (GFCI) is designed to break the flow of current to the protected outlet when an imbalance of current is detected. Imbalances include electrical leakage in an appliance such as a shaver or hair dryer that have developed a weak spot in electrical insulation. The possibility of electrocution exists when using a faulty appliance, while at the same time being in contact with an electrical ground such as water, plumbing, or the earth.

If an imbalance is detected, the GFCI will trip and shut off power to the outlet. Even with GFCI protection, the electrical shock will still be felt, but to a lesser degree.

It also does not protect against short circuits or system overloads. Circuit breakers in the main panel which supply power to the circuit, will trip if either of these conditions exist.

The GFCI receptacle should be tested initially when the RV is purchased and at least monthly thereafter.

To test the circuit, use the following procedure:

1. Make sure power is on to the circuit. A test light or a 110 lamp will work.
2. Push the test button.
3. The red reset button should pop out.
4. All power should be interrupted to outlets that are protected by the GFCI.
5. Verify by plugging in a light at these outlets, and pushing in the reset button. If the red reset button does not pop out after pushing the test button, or GFCI circuit continues to trip, or if the power is not interrupted to the test light, immediately turn off power at the circuit breaker panel and have a qualified electrician check it out.



WARNING: Even with the GFCI protection, persons with heart or other health problems may still be seriously affected by an electrical shock. The GFCI outlet is not a substitute for good electrical safety. It does not protect against contact of the hot and neutral wire at the same time.

POWER INVERTER



The inverter converts 12 volt electrical current from the coach batteries into 110 volt electrical current when an exterior power source such as, shore power or the generator, are not available for use. The inverter will supply power at a 110 volt level until the coach batteries are completely discharged or another power source becomes available.

The inverter creates heat while running and needs plenty of ventilation to run properly. Do not store items on or around the inverter. The inverter will also make an audible humming noise while operating.

Please see manufacturer instructions for further information and instructions.

BATTERY ISOLATOR CONTROLLER

When the motorhome engine is not running, the chassis and coach batteries are kept separated from each other within the electrical system through the use of an isolating controller. The controller prevents the coach batteries from discharging the chassis battery when the motorhome is parked. Some additional characteristics of the isolator system include:

1. Delays connecting the coach batteries to the charging system for approx. 15 sec. to allow the alternator time to reach full charging ability.
2. When the alternator reaches full charging ability, the isolator will electrically connect the coach and chassis batteries together for charging.
3. If the charging voltage drops below 12 volts for a period of 4 seconds due to low idol speed and/or excessive load, the isolator will disconnect the coach batteries until the voltage returns to a level of 13.3 volts for about 10 seconds.
4. In the event the automotive battery is low or fully discharged, it will be necessary to press and hold the aux. start button located on the dash. By pressing the aux. start button, power from the coach batteries will assist with starting the RV.

BATTERY DISCONNECT SWITCHES

The battery disconnect switches allow you to easily disconnect the coach and chassis batteries from electrical circuits, preventing unwanted discharge during short periods of non-use. For long periods of non-use: Walk through the RV and manually shut off all 12 volt powered items by their independent power switch, then turn the coach and chassis disconnect switches to the off position. The coach switch is mounted in an overhead cabinet above the passenger seat. The chassis switch is located within the battery compartment.



There are three main uses for the battery disconnect switches

1. Prevent unwanted discharge of batteries during extended periods of storage
2. Prevent shorts or fire hazards while working on the 12 volt electrical system
3. Can help protect the batteries in the case of overcharging.

When activating, place the switch for the desired battery system in the ON position. This battery system will now be operational.

The disconnect switches must be in the on position while plugged into shoreline power to charge the batteries.

Place the coach switch in the OFF position to disconnect 12 volt circuits.

NOTE: It is not necessary or advisable to use the battery disconnect switches as a substitute for turning off the various 12 volt applications available in the motorhome.

NOTE: If 12 volt functions are not working, be sure to check that the battery disconnect switch has been placed in the ON position.

BATTERY CHARGING

The inverter also operates as a battery charger when it is connected to a 110V power source. If the battery is below its full charge, the inverter charger will begin operation at a rate that reflects the level of discharge. When the battery is again fully charged, the inverter charger drops its charge level back to a maintenance level to keep the battery fully charged.

If for any reason you charge a battery with a source outside the RV, make sure to follow the rules of battery maintenance and safety outlined in this section. Also observe these additional safety precautions related to battery charging.

1. Disconnect the battery from the RV.
2. Check electrolyte before charging. Be sure that each cell is properly filled with distilled water.
3. Make sure to use care when connecting and disconnecting the cables from charger. A poor connection can cause an electrical arc, which can result in an explosion.
4. Remove the battery vent caps before charging, and make sure that the electrolyte does not splash out as a result of charging too quickly.
5. Check literature supplied by the battery manufacturer, and follow warnings or cautions outlined.

BATTERY MAINTENANCE



The batteries for your motorhome are located on the driver side in a rear storage compartment designated for the batteries. This compartment is sealed and ventilated for the proper storage of batteries.

It is important to make sure that the batteries are kept charged. Take time to turn off all lights or other 12 volt functions when not in use. Connect the RV to a 110 volt power supply when possible, instead of draining the batteries.

The charge condition of the batteries can be checked with the monitor panel. To check, press and hold monitor test switch while reading the charge level on the battery gauge. Charge levels indicated are divided into sections from weak through fully charged.

Battery maintenance is important. Checking the condition of a battery at regular intervals will help insure its proper operation. Here are some recommendations for checking and servicing batteries.

1. Keep the battery mounted securely. Vibrations cause early failure of many batteries.
2. Check the electrolyte level of the batteries at regular intervals.
3. Keep the battery terminals clean.
4. Check the outside of the battery for cracks. If you find cracks replace the battery.
5. Watch for overcharging.
6. Make sure the battery hold downs and carrier are kept clean and free of corrosion.

When removing a battery, disconnect the battery ground terminal first. When installing a battery, always connect the grounded terminal last.

When a battery needs to be replaced, make sure to replace it with a battery of the same characteristics as the original equipment. Consult your dealer for advice on battery replacement.

NOTE: The coach battery disconnect must be in the on position in order to charge the batteries.

BATTERY SAFETY

ALWAYS WEAR SAFETY GLASSES WHEN WORKING WITH BATTERIES



WARNING: BATTERIES CAN EXPLODE! Do not smoke or expose any battery to electric sparks or flame. Batteries when charging or discharging generate hydrogen. Hydrogen and air is a very explosive mixture.



WARNING: Do not short across the battery terminals. The spark could ignite the gases. Do not wear metal jewelry or a watch when working on a battery.



WARNING: Before doing **ANY** work on electrical systems, disconnect battery cable and the 110 volt power cord. Do not reconnect the cables until all work has been completed. This will avoid the possibility of shorting or causing damage to electrical components or shock to the servicing person.



WARNING: Battery electrolyte is a corrosive, poisonous, sulfuric acid. Avoid contact with skin, eyes, clothing, or any painted surface.

12 VOLT FUSES

INTERIOR 12 VOLT SYSTEM

A 12V DC distribution panel is located next to the 110V circuit breakers. The panel contains circuits with replaceable fuses for protection of RV 12V lines. If any line is loaded beyond the capacity of its fuse, the fuse will “blow”. A portion of the 12V load on the line must be turned off to reduce the total load on the line to a level below the capacity of the fuse. Replace the fuse with the same size fuse. **DO NOT** replace with larger fuse than indicated.

If the reduction of load on the line does not stop the “blowing” of the fuse, there may be a “short” somewhere along the 12V line, or at a non-fused 12V component on the line. Check the 12V line and any components along the line. Locate the “short” and take necessary steps to repair it. If you cannot locate the problem, have a qualified electrician check it out.

It is a good idea to keep additional fuses on hand in the RV. Replacement fuses are available at most service stations, hardware and automotive supply stores. Remember that the replacement fuse must be the same amperage rating as the original.

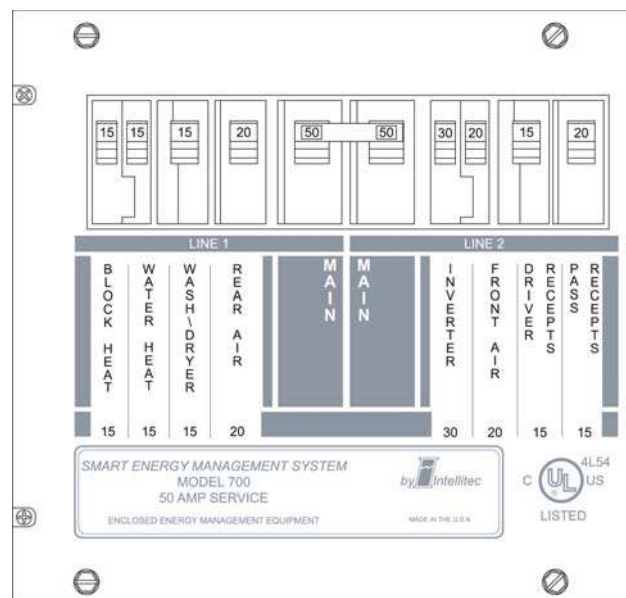

AUTOMOTIVE 12 VOLT SYSTEM

The primary point to keep in mind about the unit's 12V system is that the automotive chassis alternator supplies power to both the automotive systems as well as any coach battery and directly to the RV living quarters while the vehicle's motor is running. Thus, of primary concern to you is the condition of the vehicle's electrical system and especially the alternator.

The alternator compensates for electrical usage in the vehicle...the power drawn by the appliances, lights, fans and other 12V powered items as well as the charging of the automotive and coach batteries.

If the alternator isn't keeping pace with the draw on the unit's electrical system, while driving down the road, it means you are working in a negative mode: more power is being used than the unit is putting out.

This means that you are taking power out of the batteries. If you draw too much power from the batteries there may not be enough power left in the battery to start the RV or run any of the appliances when you stop for a break or for the night.

So, always be aware of the alternator's output. Also check the monitor panel frequently to see that the coach batteries are at full charge. To insure an accurate reading, utilize a 12 volt tester on the batteries.

The alternator will charge at a higher rate right after the vehicle has been started, replacing the power that was used to start the vehicle, but the charging should quickly go back to "normal" and hold its own even when you turn on lights or appliances.

When stopped at a campsite that allows you the use of the shoreline, the 120V electrical system will recharge your coach battery.

When checking coach battery condition, turn on several interior lights to place a load on the battery. Under heavy usage in warm weather, check the fluid level of the batteries often. Low battery fluid level is very harmful to the battery's longevity.

If the alternator shows a discharge while the motor is running, turn off appliances or lights to see if a charge comes on or if the alternator indicates not charging. Then apply a drain on the system to see if a discharge returns. If a discharge persists, contact your dealer.

LP GAS SYSTEM



WARNING: LP-Gas is highly volatile and extremely explosive. Do not use matches or a flame to test for leaks. Use only approved LP-Gas leak testing solution for leak detection. Unapproved solutions can damage copper tubing and brass fittings. Never attempt to adjust LP-Gas regulators. Only qualified personnel should perform any maintenance or repair to the LP-Gas system.

GENERAL INFORMATION

The liquid petroleum (LP) gas system in your recreational vehicle furnishes the fuel for cooking, heating, and hot water. LP gas can also be used as an alternate energy source for refrigeration. LP gas is a clean, efficient, safe form of energy when proper handling and safety precautions are observed. It enables you to enjoy a comfortable lifestyle where other forms of energy are not easily utilized.

The gas is stored under extreme pressure in the tank, with space in the tank to allow for expansion into vapor. This vapor is reduced in pressure by passing through a regulator. This reduction in pressure is a two step process which assures consistent pressure for use, regardless of outside temperatures, weather, or altitude.

Your LP system is designed to accept either propane or butane. However, since butane vaporizes at about 32 degree F, it can only be used in areas where you can be sure of higher temperatures. Propane vaporizes at approximately -40 degree F. There are different blends of propane and butane available, which will vary in the temperature at which it vaporizes. When filling your tank, select an LP gas that has a boiling point of about 40 degrees lower than temperatures you expect to travel in. Talk to your dealer or your local LP gas supplier about what you should be using.

NOTE: Even though the tank is equipped with an automatic 80% shut-off which prevents overfilling beyond 80% tank capacity, it is a good idea to have the supplier monitor the 20% liquid gauge, and stop the filling process if liquid does appear.



FILLING THE LP GAS TANK

1. Before entering the LP gas bulk plant or service station, make sure all pilot lights are extinguished. Shut off gas to all appliances by closing the LP gas main shut off valve.
2. Extinguish open flames and smoking materials.
3. Never remove the LP gas tank from the motorhome. Always drive the motorhome to the gas supplier to fill.
4. Have the supplier connect the fill nozzle to your tank fill connection.
5. Always remember to close the supply valve, and open the 20% liquid level valve.
6. Never use a wrench to close the service valve or 20% gauge. If when closing by hand, leaking occurs, have the valve repaired or replace.
7. Drive at least one mile from the LP supplier before relighting pilot lights or appliances. This will allow any minimal leakage which occurred while filling the tank to dissipate. **DO NOT** light pilot lights if you continue to smell LP gas. Shut off the Supply Valve. Allow the recreational vehicle to ventilate for 30 minutes. If you still detect LP gas odor, have the source of the leak located and repaired.

Never use any other tank than the one furnished with your recreational vehicle. If the tank must be replaced, check with your dealer for correct tank specifications and replacement procedure.



WARNING: Make sure that the tank is not filled beyond the 80% liquid level. If the tank has been overfilled, make sure the LP supplier bleeds out the excess. Overfilling the LP gas container does not allow for the necessary 20% vapor expansion space that can result in uncontrolled gas flow which can cause fire or explosion.



WARNING: Make sure the tank service valve is accessible at all times. In an emergency, it may be necessary to shut off the valve quickly.

LP TANK COMPARTMENT

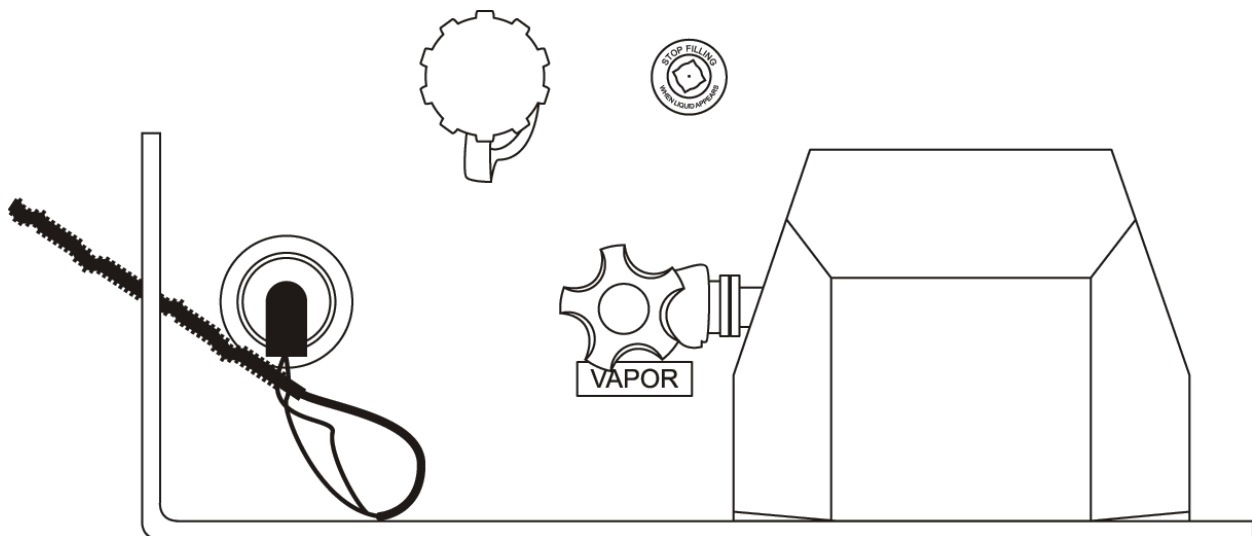

LP GAS REGULATOR

The regulator reduces the pressure of the LP gas vapor from the pressure in the tank, to the pressure required for use at the appliances. This reduction in pressure is performed by a two-stage regulator. Two regulators are used in the same body to reduce the pressure of the LP gas in the tank for use by the appliances in the recreational vehicle. The regulator seldom requires service, but it should always be protected from the elements and extremes of hot and cold.

The high pressure regulator (first stage) is used to reduce the pressure to approximately 10 to 13 PSI before sending it along to the low pressure regulator (second stage). This second stage regulator reduces the pressure further to 11 inches water column, or 6.35 ounces per square inch.

The two stages regulator does not have to work as hard since the second stage receives consistent pressure rather than inlet pressure which varies. The result is an efficient safer system that helps to eliminate problems such as freeze up and pilot outages.

The regulator has been preset by the manufacturer of the regulator, and adjustment should not be necessary. If adjustment should be required however, DO NOT attempt to adjust it yourself. Adjustment must be made with special equipment by a qualified LP gas service technician.

Have the regulator checked annually, or whenever you suspect a problem. The correct line pressure should be 6 ¼ oz. or 11 inches of water column.

Because air is required for proper operation of the regulator, it is very important that the regulator vent is kept clean and free of dirt and debris. This is why it is necessary to keep the vent facing downward and the regulator covered to protect it from contamination. A toothbrush can be used to clean the vent if it becomes clogged by foreign matter.

During cold weather, it is important to keep ice from forming in the regulator, which will shut off the flow to LP gas to your appliances. Have the supplier add a hydrous Methanol when filling your tank for use during cold weather.

Regulator freeze-up can occur in any weather if there is moisture in the tank, or if the tank has been overfilled. Always use moisture-free LP gas, and make sure the tank has not been filled beyond 80% of capacity. If moisture has entered the tank, have the tank purged, or have hydrous methanol added by an authorized LP supplier.

If you believe a regulator has been damaged or otherwise is not functioning, have it replaced by a competent serviceman.



WARNING: Never alter the positioning of the regulator. LP gas regulators must always be installed with the diaphragm vent facing downward. Also make sure to keep the regulator cover in place to minimize vent blockage which could result in excessive gas pressure causing fire or explosion. Do not rely upon being able to smell LP gas leaks, as the odor may not be sufficiently strong to detect.

REGULATOR FREEZE-UP

The term regulator freeze-up is a misleading one. Regulators and LP gas do not freeze. However, the moisture that can be contained in the gas will freeze as the gas expands and cools passing through the regulator. This freezing of the moisture in the gas can build up and partially or totally block the passage of the gas through the regulator. Freezing can also occur when outside temperatures are low enough to contribute to the freezing of the moisture in the gas.

The source of the moisture is varied. It can occur at the refinery or gas bulk plant, in the cars used to transport the gas, or even within your own LP tanks. Moisture in an LP tank can occur when a tank service valve is left open, allowing moist air to enter and become trapped.

A two-staged regulator helps to reduce the possibility of freeze-up because of its larger orifice size, and the fact that heat is transferred through the walls of two regulators instead of just one.

There are several steps that can be taken to inhibit or prevent this from happening:

1. Make sure that your LP tank is free of moisture before refilling.
2. DO NOT overfill the LP tank.
3. Make sure to keep the service valve on an empty tank closed.
4. If freezing has occurred, have your LP dealer purge the LP tank before refilling.
5. Add a hydrous methanol or other approved LP antifreeze or de-icing agent to the LP tank.
6. Keep the regulator covered at all times.

NOTE: If freeze-up does occur, shut off the LP gas at the tank. A frozen regulator may permit LP gas to flow at high pressure, resulting in leaks at appliances or in the lines. If freeze-up does occur, **NEVER** attempt to thaw with an open flame. A small light bulb can sometimes be useful to provide heat and aid the thawing process. Once thawed, be sure to take the proper steps to prevent a reoccurrence. Have the system checked by your LP supplier if freeze-up continues.

OTHER COLD WEATHER FACTORS

Remember that as outside temperatures drop, the BTU value of the LP gas is lessened, since the colder liquid LP in the tanks requires the heat from the surrounding air to vaporize. This lowering of BTU value can significantly affect the performance of the system. You can help insure proper performance by keeping your LP tanks as full as possible in cold weather, and reviewing the BTU/hr plates on LP appliances for proper LP management.

HOSES, PIPES, TUBES AND FITTINGS

The hoses, pipes, tubes, and fittings used in your LP system are designed to withstand pressures far exceeding those of the LP system. However, because environment and time can both contribute to the deterioration of these components, they must be inspected for wear at regular intervals. Be sure to inspect the hose before each season and when having the tank refilled. Look for signs of deterioration such as cracks or loss of flexibility. When replacing the hose or other LP components, make sure to always replace them with components of the same type and rating (check with your dealer).

Fittings are used to connect the various system components to each other. The P.O.L. fitting at the end of the LP supply hose is made of brass so that pipe sealants are not necessary to prevent leaking. It also has a left-handed thread, which means that it is turned clockwise to remove, and counter-clockwise to tighten. The P.O.L. fitting has been designed to help restrict the flow of LP gas in the event of a regulator failure, or hose malfunction.

LP GAS LEAK DETECTION SYSTEM

HOW TO OPERATE

Your LP Gas Leak Detector is powered at all times when the battery is connected. **If your coach is equipped with a master cutoff switch, the detector will be turned off when this switch is turned OFF.** When the detector is powered by connecting the battery or turning ON the master cutoff switch, the green indicator will light. After 60 seconds, the detector will begin monitoring the air in your coach for combustible vapors. The propane you use to cook, refrigerate, and heat is combustible. Should a leak occur, your Pre-Tell 1 will produce a pulsating alert sound when the gas reaches the detector. This alert will continue to sound until the gas has dissipated or until the reset button is pressed. **When the alert sounds, open all doors and major windows to air out the coach and turn the gas off at the tank. Do not reenter the coach until the alert stops sounding. If the alert sounds a second time after the gas is turned back on, leave the gas off and have a qualified LP Gas Dealer or RV Service Center make the necessary repairs.** The reset button only stops the alert from sounding for 60 seconds. **This device is intended for detection of LP Gas ONLY.**

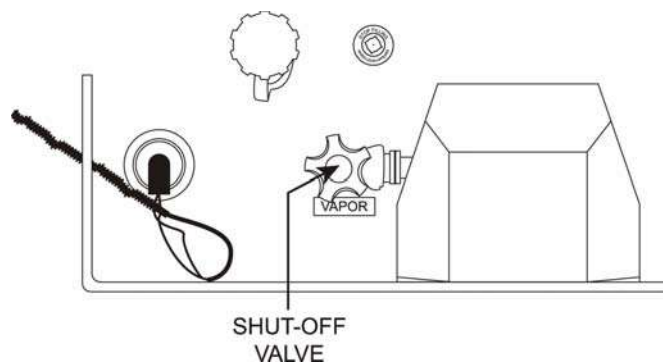

HOW TO TEST

The detector must be operating for at least 60 seconds before it can be tested. Expose the detector to gas* and observe that the alert sounder will begin to alarm. The alert will continue to sound until:

1. The gas mixture at the detector returns to a safe level.
2. The reset button is pressed. If the reset button is pressed, the detector cannot be retested for at least 60 seconds.

This test procedure should be repeated every week or every time the coach is taken on a trip, whichever occurs first.

Call (800) 521-5228
If you have any questions about
your C.C.I. LP Gas Detector

* One method of simulating gas is to use a butane lighter (i.e.: BIC). **DO NOT** rotate the flint wheel. Just press on the gas release button and point the exit nozzle into the gas sensing area below the green light of the detector.

CHECKING THE LP GAS SYSTEM FOR LEAKS

Road vibration can loosen LP gas fittings. **It is important to check your LP system for leaks at least every 5,000 miles, and whenever the tank is filled. It is also a good idea to have your entire LP gas system checked annually by a qualified LP gas service representative.**

Use the following steps when checking the system for leaks:

1. Open all the windows and vents.
2. Open the gas tank service valve.
3. Use non-ammoniated, non-chlorinated soap solution, or an approved leak detection solution on all line connections (ammoniated soap solutions can cause cracking on copper or brass lines and fittings).
4. If a leak is detected, tighten the connection with two open end wrenches until bubbling stops. **DO NOT** over tighten, or use excessive force. If the leak continues, contact your recreational vehicle dealer, or a qualified LP gas service representative to have an 11" Water Column Test performed.



WARNING: NEVER CHECK FOR LEAKS WITH AN OPEN FLAME.

NOTE: The scent of LP gas (a garlic-like odor) is actually ethyl mercaptan, an additive that allows you to detect the presence of a leak, since LP gas is naturally odorless. Do not rely upon being able to detect the smell of the gas, as the odor may fade.

ABOUT YOUR LP GAS DETECTOR

Liquid Propane (LP) Gas is heavier than air and will settle to the lowest point which is generally the floor of your coach. The detector is also sensitive to other fumes such as hair spray of which most contain butane as the propellant. Butane, like propane, is heavier than air and will settle to the floor level where it will be detected. When this occurs, press the reset button to stop the alert sound for 60 seconds.

Other combustibles which will be detected include alcohol, liquor, deodorants, colognes, perfumes, wine, adhesives, lacquer, kerosene, gasoline, glues, most of all cleaning agents and the propellants of aerosol cans. Most are lighter than air in their vapor state and will only be detected when the coach is closed up. Glues and adhesives may exhaust hydrocarbon vapors for months after they are applied. They are easily activated by high temperatures. Close your coach up on a hot day and the chemicals used in its construction may be detected for months after the coach was manufactured.

Your gas detector is powered by your RV battery and/or your inverter. It draws less current than drawn by one instrument panel lamp. Your detector will operate to detect gas until your battery is drained down to 10 volts. (Your low battery condition is 10.4 volts.) If the power source (battery and/or inverter) is disconnected, or if the power is otherwise interrupted, the detector will not operate.

Your Gas Detector has a self check circuit which runs at all times when the detector is powered. In the event that the circuitry fails, a failure alarm will sound. It is a continuous series of short beep tones between long intervals and is distinctively different from the alert sound.

MOST COMMON CAUSES OF APPARENT MALFUNCTION

- 1. New Coach Odor:** The glues and other materials used in manufacturing the coach produce vapors which may be detected when the coach is closed up on a warm day. *Air out the coach thoroughly.*
- 2. Keeps Beeping:** The gas detector beeps about once every minute, - even when it is turned off. The problem is a weak battery in the smoke detector which causes the smoke detector to produce short beeps which sound similar to the alert sound of the LP Gas Detector. This is a high pitch tone and bounces off the walls, making its location very hard to pinpoint. If the sound is not coming from the LP Gas Detector identify the source and refer to the sources section in this manual for means of repair.
- 3. Hair Spray triggers the detector:** Most aerosol hair sprays use butane gas as the propellant. Butane, like propane, is heavier than air and will settle to the floor level where it will be detected. The detector is doing its job as butane is combustible.
- 4. Other Gases:** Other gases which can cause the detector to respond with an alert include the vapors from any fuel, liquor, alcohol, deodorants, colognes, perfumes, wine, adhesives, lacquer, and most cleaning agents.
- 5. Slow beep rate:** This could be the failure alarm and will occur in the event that the circuitry fails. It is a continuous series of short beep tones between long intervals and is distinctively different from the alert sound.

After reviewing the above, if the problem still exists, call CCI for assistance.

NOTE: The LP Gas Leak Detector enters a cleaning and initializing mode every time it is powered. If turned off for less than 15 minutes, the LP Gas Leak Detector may produce several short "chirps" within the first 80 seconds of operation. This is normal.

SERVICE

See your RV Dealer or a qualified LP Gas Service Center should service be required. If they are not familiar with this product, have them call CCI for assistance. If service is not available in your area, call CCI.

LP GAS SAFETY PRECAUTIONS

IF YOU SMELL GAS:

1. Extinguish any open flames, pilot lights and all smoking materials.
2. DO NOT touch any electrical switches.
3. Shut off the gas supply at the tank valve(s) or gas supply connection.
4. Open all doors and other ventilating openings. (DO NOT USE THE RANGE HOOD).
5. Leave the area until the odor clears.
6. Have the system checked by a trained professional before using again.

Be careful when doing any work or maintenance in the recreational vehicle, that you do not puncture a gas line with a nail, screw, or drill bit.

Warning labels and decals are used throughout the recreational vehicle in locations where the potential for a dangerous situation is present. They have been installed not only because of the requirement to do so, but also as a constant reminder to occupants of the recreational vehicle to exercise proper caution when using or being around LP gas appliances and equipment. Make sure that you and your family understand and follow all of them. Never remove these warning labels and decals. If one should be lost, it should be replaced as soon as possible.



WARNING: DO NOT store LP gas containers inside the recreational vehicle. LP gas containers are equipped with safety devices which relieve excessive pressure by discharging gas to the atmosphere.

INTERIOR CONTROLS AND OPERATIONS

Your new RV from Mandalay offers virtually all the comforts of a home while out on the road. These systems are of the most modern design available, just as the similar systems in your home, however, the RV's systems may be of different design, and construction than those found in your home.

The following instructions are for items inside the recreational vehicle which are general in nature. Instructions for the operation of appliances and conveniences not found here can be found in other sections dealing directly with appliances and systems. Check in index for the location of the specific information.

REAR VISION TV MONITOR SYSTEM

Your motorhome may be equipped with the optional rear vision TV monitor system. This system gives a televised view of what is behind the motorhome. It is used as an aid in backing the motorhome, and can also be used for greater field of vision when driving in heavy traffic.

The motorhome ignition must be on to power the system. The picture is automatically activated when the motorhome is shifted in reverse. Push the standby switch down to receive the picture at any time. Push the switch out to receive in reverse gear only. Picture brightness can be controlled by rotating the reception switch. A contrast control is also provided to adjust the picture further. Adjust by rotating the switch.

Contrast and bright controls are provided to compensate for changes between day and night use. Push the light/darkness switch in for day use, push again to release for night use. Never operate the monitor in the on position for extended periods of time, this may result in an "image burn" on the monitor.

Make sure to check the mirrors when driving and backing, for a more complete field of vision. The TV camera is equipped with a wide angle lens that can initially present an image that may be deceiving. Make sure to practice backing in a safe place, using the monitor to become accustomed to its operation.

LIVING QUARTERS

Construction of your Mandalay RV is the best in the industry when it comes to strength and energy conservation. These new building techniques greatly reduce air exchange between the inside and outside, thus creating a very airtight vehicle.

This creates some problems than can easily be resolved by airing out the vehicle on a regular basis, especially in warm, humid conditions and after storage. Also, during prolonged cold weather where the heating system is in use, other procedures should be followed as detailed in the last suggestion in the Safety portion of this manual.

CONDENSATION

Condensation can be more of a problem in the well-built RV than in the average home. Bathing, dishwashing, cooking, washing and drying clothes and the use of non-vented gas burners all contribute to the added moisture level.

A few easy procedures can help reduce the problem and include closing the door to the bathroom and opening the window vent during bathing and for a short period afterwards; using the overhead vent while cooking, and making sure the clothes dryer is vented to the outside of the unit. Also, don't hang wet clothing inside the RV to dry.

Taking care to keep down the amount of condensation will help prevent your unit's insulation from becoming damp and dropping its efficiency.

During the summer always try to park in a site that will be shaded during the hottest part of the day. Window awnings are very helpful in keeping inside temperatures down.

Also, during hot weather, be aware that air conditioners need to operate on voltage of 110 to 120 and anything lower can result in overheating of the motor and excessive wear, resulting in shorter life of the unit. Dim lights and a poor, narrow television picture are indicators of a low voltage source. Use a volt meter to check outside electrical sources.

OVERHEAD VENTS

Vents are provided in the recreational vehicle to circulate fresh air and exhaust odors.

Bathroom Power Vent – The power bath vent has dual controls to operate both opening and closing, as well as the exhaust fan. A hand crank controls opening and closing and adjustment of the vent cover, while a push button turns the exhaust fan on and off. Make sure to turn the fan off before closing the vent. Also be sure to remove any debris that falls into the vent that may restrict its operation.

HYDRAULIC POWER LEVELERS

General Description

The optional power leveling system allows you to quickly level your motorhome from the driver's seat by adjusting levers and watching a panel of indicating lights.

The following instructions are general instructions. You should refer to the separate manual for the levelers for additional information.

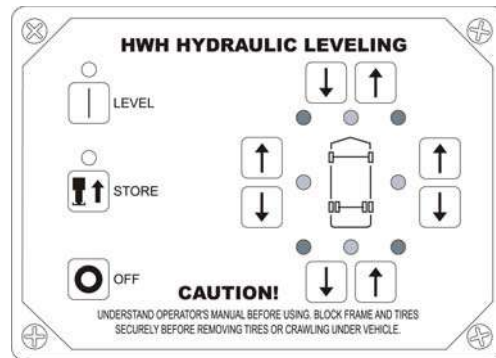

CAUTION!

READ THE ENTIRE OPERATOR MANUAL BEFORE OPERATING.

BLOCK FRAME AND TIRES SECURELY BEFORE ATTEMPTING ANY MAINTENANCE UNDER THE VEHICLE. DO NOT USE LEVELING JACKS OR AIR SUSPENSION TO SUPPORT VEHICLE WHILE UNDER VEHICLE OR CHANGING TIRES. VEHICLE MAY DROP AND/OR MOVE FORWARD OR BACKWARD WITHOUT WARNING CAUSING INJURY OR DEATH.

KEEP ALL PEOPLE CLEAR OF VEHICLE WHILE LEVELING SYSTEM IS IN USE.

NEVER PLACE HANDS OR OTHER PARTS OF THE BODY NEAR HYDRAULIC LEAKS. OIL MAY PENETRATE SKIN CAUSING INJURY OR DEATH.

WEAR SAFETY GLASSES WHEN INSPECTING OR SERVICING THE SYSTEM TO PROTECT EYES FROM DIRT, METAL CHIPS, OR LEAKS, ETC. FOLLOW ALL OTHER APPLICABLE SHOP SAFETY PRACTICES.

DO NOT OVER-EXTEND THE REAR JACKS. IF THE WEIGHT OF THE VEHICLE IS REMOVED FROM ONE OR BOTH REAR WHEELS, THE VEHICLE MAY ROLL FORWARD OR BACKWARD, OFF THE JACKS.

SLIDE-OUT

In order for the flush floor slide-out to level properly when extended, the slide-out will tilt while in motion. During travel the slide-out travels up and then down the flush floor slide-out ramp.

NOTE: Refer to the **HWH** hydraulic space maker room extension system operator's manual for complete details and trouble shooting guide.

ROOM EXTENSION PROCEDURE



CAUTION: Operating the room with any room-locking device locked can cause personal injury and vehicle damage. It is the operator's responsibility to ensure that all room-locking devices are disengaged before operating the room.



CAUTION: Keep people and obstructions clear of room when operating The Pilot and Co-Pilot seats must be in their most forward position, with seat backs in the vertical setting.

NOTE: Make sure there is adequate clearance to fully extend the room.

1. Apply the parking break and activate the coach battery disconnect switch to apply power.
2. Insert the **SLIDE OUT CONTROL PANEL KEY** and turn the **KEY SWITCH** to the "ON" POSITION.
3. To extend the room, press and hold the **ROOM CONTROL SWITCH** in the "EXTEND" POSITION. The room-locking device will disengage and retract into the slide-out housing. When the room is fully extended, release the **ROOM CONTROL SWITCH**.

NOTE: The bottom of the room will begin to move prior to the top of the room.

IMPORTANT: Do not hold the **ROOM CONTROL SWITCH** in the "EXTEND" POSITION for more than ten seconds after the room is fully extended or stops moving. **IF EITHER SIDE OR THE ROOM STOPS MOVING, RELEASE THE ROOM CONTROL SWITCH IMMEDIATELY.**

NOTE: Releasing the **ROOM CONTROL SWITCH** will halt the operation of the room.

4. Turn the **KEY SWITCH** to the "OFF" POSITION.



NOTE: Perform the slide-out room operation with the air suspension system full. Extensive damage could occur to the slide-out room and awning when extending the slide-out room in snow, sleet, ice or freezing rain. In such conditions, if the slide-out room is extended, clear the awning and ensure free movement prior to operating the slide-out room.

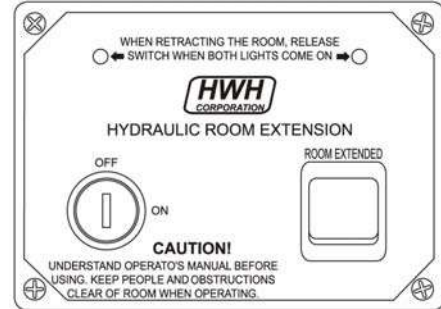
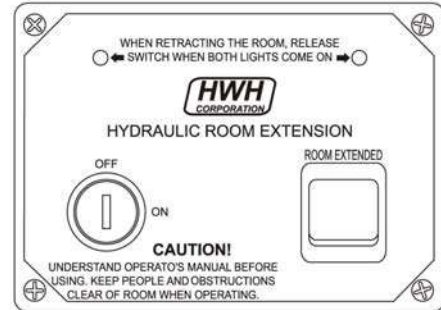



CAUTION: Dirt and grit trapped under the slide-out room could result in damage to the floor. Continuous operation of the slide-out could cause a drain on the coach batteries and damage to the slide-out motor.



NOTE: Do not leave the slide-out in the extended position during severe weather. Conditions such as high winds or heavy rain may cause damage to an extended slide-out.

ROOM RETRACTION PROCEDURE

CAUTION: Keep people and obstruction clear of room when operating.

1. Make sure parking brake is applied.
2. Insert the **SLIDE-OUT CONTROL KEY** and turn the **KEY SWITCH** to the **"ON" POSITION**.
3. To retract the room press and hold the **ROOM CONTROL SWITCH** in the **"RETRACT" POSITION**. The room-locking devices will extend from the slide-out housing and then engage. When the slide-out control panel illuminates both LED light indicators, release the **ROOM CONTROL SWITCH**.

NOTE: The top of the room will come into contact with the body of the motorhome first. The leading edge of the room floor will rise up as the bottom of the room is drawn in.

IMPORTANT: Do not hold the **ROOM CONTROL SWITCH** in the **"RETRACT" POSITION** for more than 10 seconds after the room is fully retracted or stops moving. **IF EITHER SIDE OF THE ROOM STOPS MOVING, RELEASE THE ROOM CONTROL SWITCH IMMEDIATELY.**

NOTE: Releasing the **ROOM CONTROL SWITCH** will halt the operation of the room.

4. Turn the **KEY SWITCH** to the **"OFF" POSITION**.
5. Remove the **KEY** to prevent undesired operation of the room.
6. If the room will not retract see the **MANUAL ROOM RETRACTION PROCEDURE**.



CAUTION: Be sure you have sufficient clearance on the inside of the motorhome (driver's seat, etc.) before you retract the slide-out room. Ensure the floor is clean before you retract the slide-out room. Trapped dirt or grit under the slide-out room can scratch the floor surface. Never move the motorhome with the slide-out room extended.

MANUAL ROOM RETRACTION PROCEDURE

(USE ONLY WHEN THE ROOM WILL NOT RETRACT WITH THE ROOM CONTROLS SWITCH)

OVERVIEW - The room can be retracted manually if a hydraulic or electrical failure prevents the room from being retracted using the **ROOM CONTROL SWITCH**. For normal retract sequence see the **ROOM RETRACT PROCEDURE**.

1. Locate the **HYDRAULIC PUMP/MANIFOLD** unit in an exterior storage compartment.
2. Open the **SOLENOID VALVES** by turning the "**T**" **HANDLES** counterclockwise.

NOTE: The "**T**" **HANDLE** may turn easily at first but will become more difficult to turn as an internal spring is compressed. Be sure to open both valves completely (about six turns of "**T**" **HANDLE**).

NOTE: The room may move slightly as the **SOLENOID VALVES** are opened and internal pressure is released.

3. Manually push the room in from the outside at the floor level. This may require assistance from a second individual.
4. Once the room is pushed into place, close the **SOLENOID VALVE "T" HANDLES** before moving the vehicle to prevent the room from extending while driving.
5. The system should be repaired before using again.

MAINTENANCE OIL LEVEL

It is important that all rooms are fully retracted before checking the hydraulic oil level. To check the oil supply, remove the breather cap from the top of the hydraulic oil reservoir. The oil level should be approximately one inch below the top of the reservoir when adequately filled. Use **DEXRON II** or a high quality multi-purpose automatic transmission fluid.

WINDOWS

All the windows that open in the recreational vehicle are operated by sliding them back and forth. To operate, pivot the latch to release it from the locked position, and slide the window to open. When closing, slide the window fully closed, and pivot the latch back to the fully locked position. The screens will also slide open and closed if required for an emergency exit. Check window sealant during normal coach washing and as per the maintenance guide.



WARNING: To avoid exhaust gas entry into the motorhome, keep windows closed when the chassis or generator engines are running.

DOORS, DRAWERS, AND STORAGE COMPARTMENTS

Cabinet and closet doors in the recreational vehicle have door fasteners, or pneumatic stops, which prevent them from accidentally opening during travel. Drawers throughout the recreational vehicle have travel stops which keep them from sliding out when in motion (under normal driving conditions).

To open a drawer, lift up first, and then slide out. When closing drawers, make sure they drop slightly into the travel position.

Make sure before operating your recreational vehicle that all cabinet doors and drawers are closed, and cabinet contents are secure. Retract and secure sliding doors in the bath area, as well as the bath door, to prevent noise and/or damage while traveling.

UNDER SOFA STORAGE (Some Models) - Access the available storage under the sofa by lifting the front seat section and pulling towards you. Do not lay seat down completely.

UNDER THE BED STORAGE - There may be a large storage area located under the bed. It is accessed by grasping the end ledge at the foot of the bed and lifting. Make sure before lifting, that there is nothing on the bed that will restrict its movement, or add extra weight.



WARNING: Use caution when lowering the bed to keep hands and fingers at the end ledge provided; and not on the side or further back than necessary, where you may encounter pinch points.

Pneumatic struts on both sides of the storage compartment aid both in lifting, and holding the bed in the upright position. When storing items under the bed, be sure to leave space in the storage compartment for the struts when the bed is closed.

When lowering the bed, there will be some resistance felt at first, because of the struts. Be sure to keep both hands on the end ledge all the way down to the closed position to avoid having the bed suddenly drop shut.

Store items in the areas designated for storage. **DO NOT** store anything in the area reserved for the inverter and electrical panels or the water tank and pump.

SEATING, TABLES AND ADDITIONAL BEDS

Depending on which model and options you have in your recreational vehicle, seating will include some combination of the following:

1. SOFA - The sofa will comfortably seat three adults. It also converts to a bed by lifting the front section and pulling toward you. The sofa back follows and pivots down into a prone position. To reconvert back to a sofa, lift the front and push back and down into place. The sofa back will follow and pivot up into its upright position automatically. When reconverting to the sofa configuration, make sure to pull the seat belts out to their usable positions.
2. J-LOUNGE SOFA - The J-Lounge will seat 3 adults, and by using the built in seat belts, can be used while in transit.
3. RECLINER - The recliner operates just like a standard household recliner. By pulling the footrest lever, the footrest will extend. Since a seatbelt is not provided on the recliner it is not to be used while in transit.
4. DINETTE - The dinette will seat four people. Storage and/or various systems components can be accessed from above by removing the seat cushions and lifting the seat supports.

Pedestal Type Dinette - The dinette can also be converted into an additional bed if required, to convert, lift the table top off of the two support posts. Remove the support posts from the floor and lay them down between the seats. Insert the table top between the seats on the ledges provided. Loosen the seat cushion from the velcro fasteners and slide together to form the bed. Reverse this process when reconverting to the dinette configuration.

Wall Mounted Type Dinette - Lift the aisle side of the table and unhook from sidewall and swing into place. The table supports on the dinette base.

5. FOLD-DOWN LOUNGE TABLE - This table is stored in a folded position next to the lounge chair. To raise for use, pull out on the bottom to release it from its securing catch, and swing up. When raised reach under the table and swing the supporting leg down until it locks into position. Adjust the length of the support leg, so that the table will be level when resting on it. To adjust the support leg length, pull back on the spring clip, releasing the detent from the adjustment hole it is presently in. While holding the spring clip back, slide the leg to the desired length, then release the spring, allowing the detent to lock into the new hole.

To fold back for storage, reverse the previous procedure; shortening the support leg, and folding the leg up against the bottom of the table top. Lower the table top and push in on the bottom to secure it into catch that keeps the table from moving while traveling.

6. FREE STANDING DINETTE CHAIRS - Some models have free standing dinette chairs. Since these chairs are not permanently attached to the floor, and not equipped with seat belts, they should not be occupied while the recreational vehicle is in motion. These chairs should be stored securely while the vehicle is in motion.