



KING LONG
B U S E S

OPERATION MANUAL

User's Guide



King-Long XMQ6120C series tourist bus

Xiamen King Long United Automotive Industry Co., Ltd.

FOREWORD

King-Long XMQ6120C series touring bus keeps features of superior economy, security and comfort. It has stable performance, strong power, luxury interior trimming and high speed, which could meet applications of passenger inter-city transportation, touring and business affairs, etc.

As for the specifications introduced in relate to information of the driving and operation, service and maintenance of the XMQ6120C series touring bus, please read them carefully and make proper operation, maintenance and repair so as to ensure it in good condition. Special hint: without authorization of Xiamen King Long United Automotive Industry Co., Ltd, never modify the electrical deployment of the whole vehicle, and should not lap the power supply line in disorder. Improper usage and repair may have a strong impact on service performance of the complete vehicle, and thus the manufacturer , Xiamen King Long United Automotive Industry Co., Ltd. will not takes the responsibility for the damages caused by them.

Any problem in service, please contact our special maintenance network or after-sales department. We will ensure timely and complete maintenance as well as original parts supply.

In order to satisfy all kinds of different demand of the consumers, we strive to improve the quality of the product continuously to optimize our products. We should not give any further notice for any modification of the product in advance . The contents on the instruction book can only be used as reference. If there are facts not comply with the manual, will be subject to the actual state of the products because for some device and items, the vehicle will be finally equipped only if they have been taken as optional configurations.

Final interpretive right of the instruction book belongs to the technical center of Xiamen King Long United Automotive Industry Co., Ltd.

Xiamen King Long United Automotive Industry Co., Ltd.

FEB. 2014

Contents

Vehicle picture-----	1
Foreword-----	2
Contents	
Contents-----	3
Main overall technical parameters	
Technical parameters -----	7
Introduction to name plate-----	8
Product quality assurance -----	8
Technical document -----	8
Vehicle body structure-----	9
Schematic illustration of the driver zone-----	10
Operation Instruction	
Instrument instruction-----	I-1-7
Illustration of switch and indicator s-----	SI-1-6
Air conditioner control panel-----	P-A-1
Pre-heater panel-----	P-H-1-2
Gearbox operation -----	O-G-2-3
Open or close the passenger door-----	O-K-1-2
Adjustment of the driver's seat-----	OI-1
Horn button-----	OI-2
Adjustment of the steering wheel-----	OI-3
Ignition switch-----	OI-4
Lamplight operating handles-----	OI-5
Wiper operating handle-----	OI-6
Retarder operation-----	O-R-1
Passenger control panel-----	OI-8
Safety hatch-----	OI-9
Safety hammer-----	OI-10
VDO module location & function description-----	O-E-1-2

Switch control box-----	O-E-3
Vehicle starting and driving	
Check oil level of the engine-----	S-1
Check level of the coolant-----	S-2
Check fuel pre-filter with water separator-----	S-3
Check fuel level-----	S-4
Check vehicle lighting, intermittent lights and brake lights-----	S-5
Check the level of AdBlue and the daily maintenance of SCR system-----	S-7
Drain water in air tank-----	S-8
Check engine oil pressure-----	S-9
Check Pneumatic pressure-----	S-10
Check Tachometer working order-----	S-11
Steering wheel play-----	S-12
Check tire for abrasion and pressure and tire nut for fixture-----	S-13
Air cleaner-----	S-14
General leakages (water, oil, fluids and fuel) -----	S-15
Fastening and state of seat belts-----	S-16
Check emergency devices and driver's tools(fire extinguisher) -----	S-17
Windshield wipers and conditions of wiper blades and arms-----	S-18
Electrical rearview mirror-----	S-19
Power steering system-----	S-20
Clutch actuation system fluid level-----	S-21
General state and tension of drive belts-----	S-22
Clutch actuation system fluid level-----	S-21
General state and tension of drive belts-----	S-22
Check level of battery electrolyte-----	S-24
Procedures for engine start up-----	S-25
Engine shut down-----	S-26
Engine start up and shut down in the engine compartment-----	S-27
Starting the vehicle-----	S-28

Parking the vehicle-----	S-29
Vehicle maintenance and service	
General knowledge-----	M-1
Maintenance of engine and chassis subassembly-----	M-1
Body maintenance -----	M-1
ABS system maintenance and service -----	M-1
Electrical system maintenance and notices -----	M-2
Tire transposition-----	M-2
Adjustment of the clutch pedal freeplay-----	M-3
Adjustment of the brake pedal freeplay-----	M-3
Bus cleaning-----	M-3
Cleaning air filter -----	M-4
Cleaning outside of radiator -----	M-5
Coolant specification -----	M-5
Oil specification recommendation of the fuel and the lubricant-----	M-6
Breaking-in of a new vehicle-----	M-9
Daily or Refueling Maintenance Operation-----	M-11
Maintenance first 2500km -----	M-12
Maintenance per 5000km-----	M-13
Maintenance per 10000km-----	M-16
Maintenance per 20000km-----	M-17
Maintenance per 40000km -----	M-20
Maintenance per 80000km -----	M-20
Maintenance more than 80000km-----	M-21
Maintenance period chart-----	M-23
Common trouble and its eliminating method	
Engine Common trouble and elimination -----	C-1
Clutch-----	C-6
Propeller shaft-----	C-8
Transmission-----	C-9

Rear axle-----	C-10
Front axle and steering system-----	C-11
Braking system-----	C-14
Electrical equipment and the starting system -----	C-16
Air conditioner system-----	C-18
Appendix	
Driver's tool table -----	A-1
Tightening moment of the bolts and the nuts in major position -----	A-2
Air braking schematic diagram (with air suspension) -----	A-4
Electrical elementary diagram of vehicle -----	A-5

**Technical parameters of the complete vehicle
 (vehicle No. DC100031)**

Product Model		XMQ6120C	
Engine model		ISL8.9E5 340B	
Engine type		In-line six-cylinder water-cooling four stroke electronically controlled common rail direct-injection diesel engine	
Cylinder diameter × stroke (mm)		114×144.5	
Displacement (mL)		8900	
Compression ratio		16.6: 1	
Rated capacity / rotation speed Kw/r/min		250/2300	
Max. torque / rotation speed N.m/r/min		1500/1300	
Dimensions	Overall length (mm)		12200
	Overall width (mm)		2550
	Overall height (mm)		3300 (to air-condition)
	Wheelbase (mm)		6200
	Wheel track	Front (mm)	2080
		Rear (mm)	1860
	Minimum lift-off clearance (mm)		150
	Approach angle (°)		≥9
	departure angle (°)		≥8
Front suspension / rear suspension (mm)		2700/3300	
Rated passenger (driver included) (person)		55+1	
Mass parameter	Kerb weight (kg)		12300
	Max. gross mass (kg)		18000
	load NO	Front axle (kg)	4600
		Rear axle (kg)	7700
	load Full	Front axle (kg)	6500
Rear axle (kg)		11500	
Wheel	Tire size (front, rear)		295/80R22.5
	Tire inflation pressure		800
Performance parameter	Max. speed (km/h)		≥100
	Fuel consumption (L)		26
	Maximum gradeability (%)		≥30
	Min. turning diameter (m)		≤24
	parking braking ability (20% gradient)		Parking for 5 minutes
Capacity data	Fuel tank (L)		300
	Engine oil (L)		20
	Transmission lubricant (L)		11.5/13
	Main retarder lubricant (L)		5
	Power steering hydraulic oil (L)		8
Clutch oil (L)		1.3	

Introduction to specification data plate



Bus data plate

The bus data plate may be affixed to either the upside of the front passenger door frame or to the side of the front passenger door step (the position may vary with vehicle model). There are many parameters on the plate, such as vehicle model, gross mass, vehicle serial number, vehicle capacity, VIN (short for vehicle identification number), chassis serial number, engine serial number, engine model, rated power, production data and etc..

Chassis data plate

The chassis data plate is on right (or left) lateral surface of the front wheel position of the main sill with vehicle identification number (VIN) on the frame.

Engine data plate

The engine data plate is on top surface or salient top position of the engine, whose position may be various according to different engine manufacturing plant.

The engine number is stamped on the left or right block of the engine, whose position may be various according to different engine manufacturing plant.

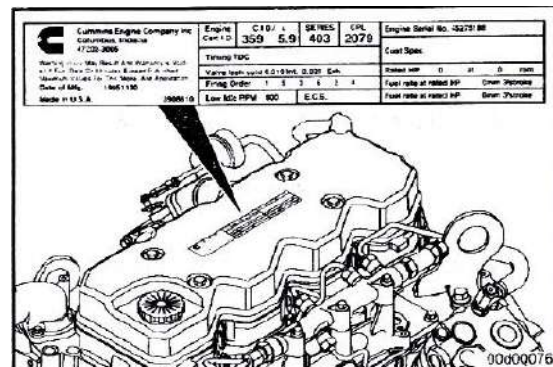

Product quality assurance

We make breaking-in maintenance of the rolling-out new vehicles in their initial driving mileage of 5000 km. Users should make proper operation and maintenance strictly according to relevant regulations in the instruction book. Please refer to “workshop manual” for product quality assurance and abide by related specification.

Technical document

The instruction book is used combined to the following specification:

Engine operation instruction or service manual Air conditioner instruction book

Transmission operation manual Heater instruction book

CAN BUS Instrument system instruction book Monitor instruction book

ABS anti-braking system instruction book VCD/DVD instruction book

Note: the instruction book should be modified according to specific configuration of vehicle.

Body Structure

1. Structural style

Semi-integral body structure

2. Structure

The bodywork structure adopts closed girder construction of five major assembly parts, which are combined welded by rectangle steel pipes with advantages of strong structural stiffness, torsion resistance and bending resistance as well as relatively simple craftwork. Main components of skeleton have been performed anticorrosion treatment to ensure steady adhesion of coating and strong capacity of antirust and corrosion-proof.

3. Interior trim

The interior adopts flexible design and the floor adopts steel plate/wood block composite construction, and covered with anti-slip and antifriction leather with favorable sound insulation value.

4. Windows

The front windshield is the hyperboloid triplex glass fixed by the gluing; the rear windshields are the hardened glass fixed by the gluing; the side windows are close cycle window which are made of hardened glass. The driver's window is fixed with sliding window.

5. Baggage compartment

The baggage compartment adopts transverse run-through design, and they are all made of aluminum.

6. Seat

Driver's seat: adjustable seat with high backrest and three-point belt (E-MARK) .

Passenger seats: 3+2 layout, high backrest, the all seats are equipped with three-point safety belt, step plate.

7. Interior accessory device

The vehicle is equipped with electronic clock, sunshade, safety hammer, emergency escaping window, curtain and luxury bilateral F-1 type luggage rack, guiding seat, reversal monitor, Vehicle traveling data recorder ,reading lamp, drinking trough, guide mike .etc.

8. Air-conditioning system

Cooling system: KINGLONG top mounted dependent air-conditioning system.

Defroster: King Long cooling /heating defrosting device

Heating: WEBASTO system

9. Door

The door adopts the full aluminum remote control out-swing pneumatic doors.

The out-swing door adopts the advanced electrically aerodynamic theory design, with the motion of opening and closing placidly、 agile、 safe、 lock credible and anti-clamp function.

A. Basic function

a. There are two electrically switches, the interior one is trigger touch-tone, which located on the dashboard of the front right side of the driver, the outside one is a remote control switch. , both switches can control the door.

b. When the circuit is in OFF position , the emergency switch can be used in the interior, the emergency switch of the door is located on the lower right side of the entrance of the door , Please rotate the switch and throw open the door in emergency.

c. Commonly the door is closed, when touch off any electrically switch, the door would move placidly at a certain velocity, along with it, the step-lamp lights .when touch off the switch again , the door would return placidly at a certain velocity, after the door returned , the step-lamp goes out.

B. Hint:

- a. The door remote control acts only when the parking brake is on the parking gear.
- b. The door could only be opened when the external mechanical lock isn't locked up.
- c. In order to avoid impact, make sure that the door is completely closed or opened, before you make the next door switch operation.

Note: Deployment on the vehicle may be different with the above description because of different deploying requirement of the clients.

Schematic illustration of the driver zone



- | | |
|-----------------------------------|-----------------------------|
| 1 WEBASTO Heating operation panel | 10 horn |
| 2 Nanfeng radiator panel | 11 Steering wheel |
| 3 A/C control panel | 12 Combination instrument |
| 4 VOITH gearbox operation panel | 13 Light control hand lever |
| 5 Parking brake hand lever | 14 Rocker switch |
| 6 Charging socket | 15 Back guide monitor |
| 7 Wiper operation hand lever | 16 Rocker switch |
| 8 Mirrors control button | 17 Charging socket |
| 9 Extinguisher press button | |

Instruction of instrument (Siemens Edition)

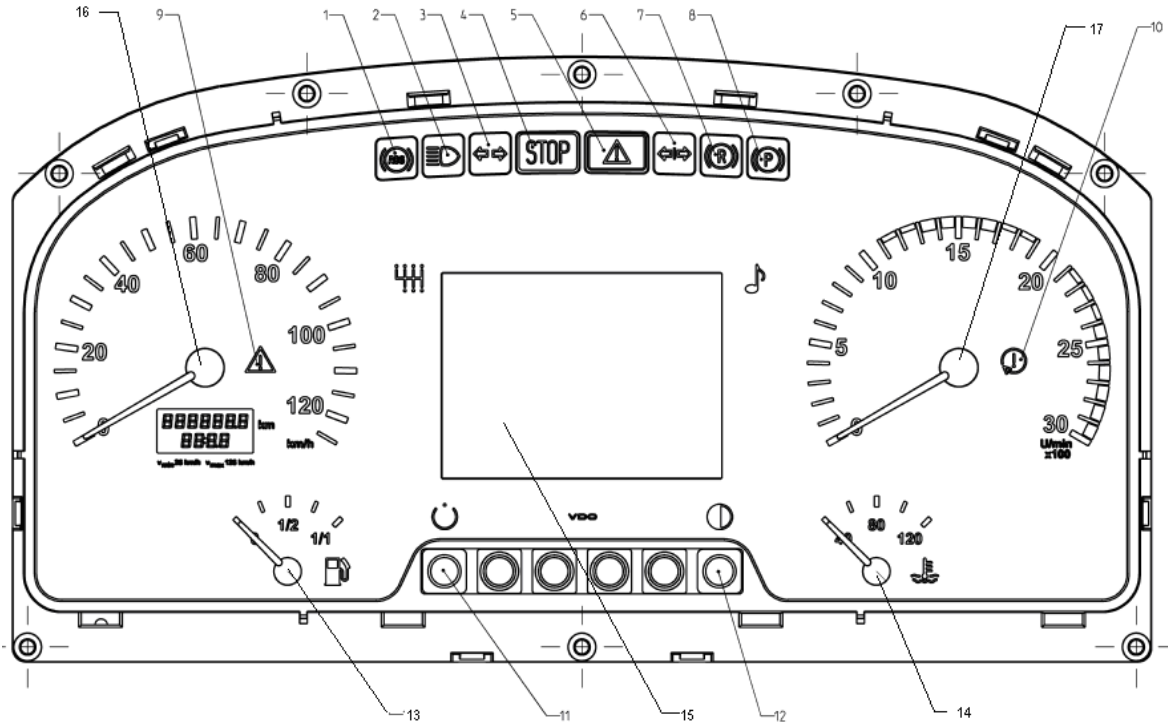

No.	Function	Description
1	ABS indicator	ABS work/warning
2	High beam indicator	When High beam is switched on
3	Left turning indicator	When Left turning/hazard switch is turned on
4	Severe Error	When the electrical system has severe error. (see1.1)
5	General Error	When the electrical system has general warning. (see1.2)
6	Right turning indicator	When Right turning/hazard switch is turned on
7	Retarder indicator	Retarder work/warning
8	Parking brake	
9	DTCO warning	communication error or without drivers card
10	Engine Revolution speed too high	Need to change the gear or slow down the bus
11	Trip distance reset button	Set trip distance to 0
12	LCD illumination adjust button	Press the button to adjust the illumination of LCD
13	Fuel level gauge	The fuel remain
14	Coolant temperature gauge	Temperature of engine coolant
15	LCD display	
16	Speedometer	Current vehicle speed
17	Odometer	Current engine speed

1.1 Severe error conditions

EDC red lamp; ECAS red lamp; EBS red lamp; coolant level low; battery not charging (after engine starts); worn brake shoes; brake circuit 1/2 pressure low; coolant temperature high; catalyst level low; engine cabin temperature high; oil pressure low (after engine starts).

1.2 General error conditions

Hammer not at right position; ASR error; air filter block; ECAS amber lamp; EBS amber lamp; rear flap open; toilet water level low; steering oil level low; steering oil pressure low; fuel level low; DM1 error; light error; communication error.

2 LCD Display

Press the page switch button, the pages will be displayed by the following sequence. Detailed description is listed as below:

2.3 Driving Information

When the bus is running, this page will show (Figure-1):

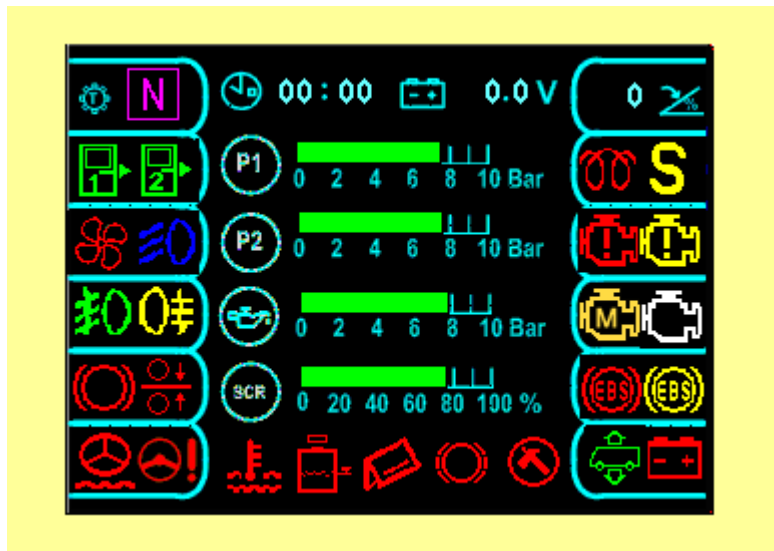



































Figure-1 driving information

pictogram	comments	pictogram	comments
	Gear info (see 2.1.1)		Acceleration pedal position
	Current time (see 2.1.2)		System voltage (see 2.1.3)
	Front door status (see 2.1.7)		Preheating indicator
	Mid door status (see 2.1.7)		Passenger service/request from cabin(see 2.1.9)
	Fluid fan error		Engine red lamp error

pictogram	comments	pictogram	comments
	Low beam working		Engine amber lamp error
	Front fog light working		Engine Malfunction
	Rear fog light working		Engine wait to start (do not start the engine until this symbol disappear)
	Brake light working		EBS red lamp warning
	Lift-axle lock		EBS amber lamp warning
	Steering oil level low		ECAS status (see2.1.8)
	Steering oil pressure low		Battery not charging (indicate charging error if this symbol still exist after engine starts)
	Coolant temperature high (>=98°C)		The bar shows brake circuit 1 pressure
	Coolant level low		The bar shows brake circuit 2 pressure
	Rear flap open (can not start the engine)		The bar shows engine oil pressure
	Worn brake shoes		The bar shows SCR remain
	Hammer not at right position		

Function description

2.3.1 Transmission gear Display:



: current gear is "neutral";



: current gear is "forward";



: current gear is "reverse";

2.3.2 Time:

This information comes from DTCO.

2.3.3 System voltage:

This value shows the battery voltage when generator is not working; and shows the voltage by generator after engine starts.

2.3.4 Acceleration pedal position:

Range: 0 – 100 %.

2.3.5 Oil pressure:

This information comes from engine ECU. Before engine starts, the value is 0.

2.3.6 Brake system pressure:

Brake circuits 1 refers to the front brake system pressure.

Brake circuits 2 refers to the rear brake system pressure.

The symbol becomes red if the pressure is too low or if sensor is open-load.

2.3.7 Door status:



: green; means door is open



: yellow; means the cap on the emergency switch is open (either inside or outside)



: brown; means the knob in the emergency switch is moving

2.3.8 ECAS status



: ECAS lift



: kneeling



: ECAS general error



: ECAS severe error

2.3.9 Service request



: Passenger service request



: Request from cabin

2.2 Error display Page:

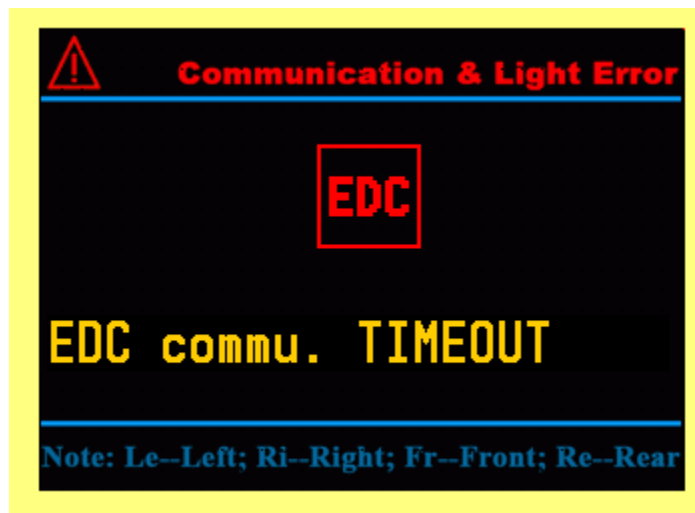

Figure -2 text error information

If there is error exists, this page will show after driving information page when you press the page change button.

Description:



Pictogram: object name;

Text: detailed description of the error;

Errors can be displayed in this page:

- Communication Error: EDC, EBS, TCO, AC, Front node, Top node, Cabin node, Rear node;
- Light Error: high-beam, low-beam, reverse light, front fog light, rear fog light, brake light, turning light
- Other Error: brake circuit pressure open-load, fuel-sensor open-load, Engine cabin too hot, worn brake shoes (1-6), fuel level low, water in toilet level low, air filter block,

2.3 DM1 Diagnosis Information

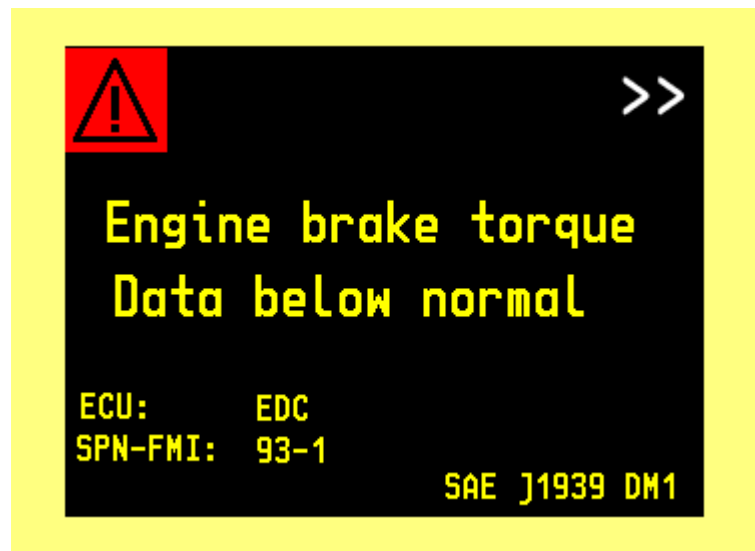

Figure -3 DM1 display page

This page will show when some ECU sends out DM1 message. The diagnosed ECU must support CAN diagnosis, and provides SPN-FMI code.

Line1: the object that has error (from SPN).

Line2: Error status (from FMI)

Line ECU: name of the ECU that sends the message (i.e. EDC, EBS, AC)

Line SPN-FMI: the SPN and FMI combination



: means this error is not the last one

Other contents are fixed

2.4 Air conditioner status

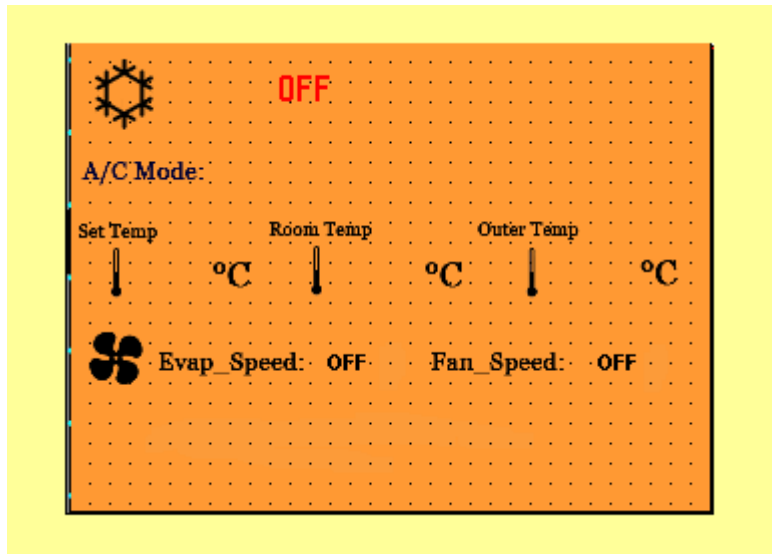

This page will appear is air conditioner is working and the communication is right.

A/C mode include: ventilation; heating; cooling; demist/defrost; auto mode; off

Set temp: the temperature currently set to be;

Room temp: the real ambient temperature in the bus;

Outer temp: outside temperature;

Evap_speed: OFF; High; Mid; Low

Fan_speed: OFF; High; Low

2.5 Engine Cabin Temperature high warning page

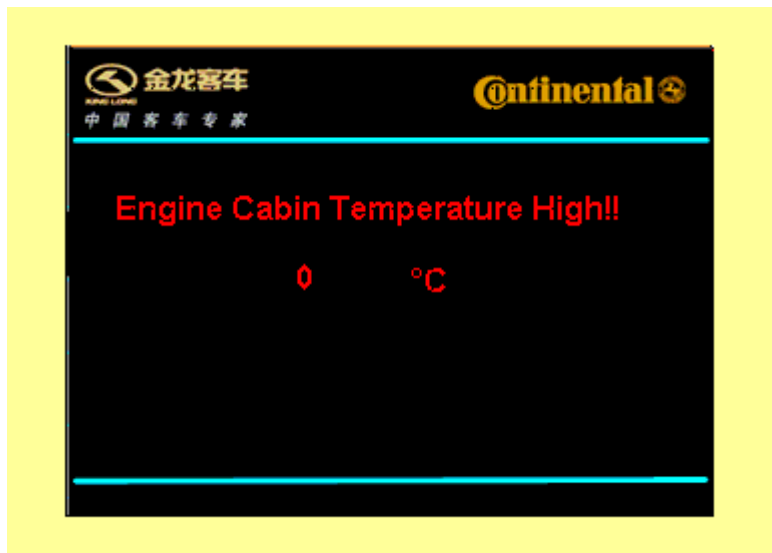











If engine cabin temperature is higher than 85°C, this page will appear automatically. The temperature will show on the page. The driver need to press the page change button to switch to the driving page

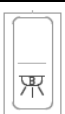





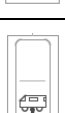







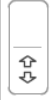

2.6 Beeper warning conditions











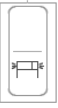
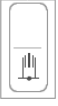



- Brake circuit 1 pressure low
- Brake circuit 2 pressure low
- Coolant level low
- Hammer not at right position
- Engine cabin temperature high
- Oil pressure low (after engine running)
- Service request
- Left turning
- Right turning.







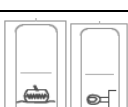



Illustration of switch and indicator











Number of switches and indicators and position may vary with vehicle model, please consult the flowing sheet and use correctly according to actual condition of vehicle.



Switch	Name	Color	Function	Notes
	Retarder	Green	Pressed on top: retarder is turned ON Pressed on bottom: retarder is turned OFF	
	Retarder turn off switch		Pressed on top: retarder is turned OFF Pressed on bottom: retarder is turned ON	
	Daylight lamp	Green	Pressed on top: interior lighting ON, Pressed on bottom: interior lighting OFF	
	Hazard lamp	Red	when the vehicle have a screw loose, switch it on, the whole vehicle lamps light	
	Luggage compartment lamp	Green	Pressed on top: lamp lights , Pressed on bottom: lamp goes out	
	Compulsory radiator	Green	Pressed on top: radiator working ; Pressed on bottom: to turn it off	only use this button when vehicle is stopping
	Ventilator	Green	Pressed on top: ventilator is active, Pressed on bottom: ventilator is turned off	
	Front fog lamp	Green	Pressed on top: front fog lamps ON, Pressed on bottom: front fog lamps OFF	
	Rear fog lamp	Yellow	Pressed on top: rear fog lamps ON, Pressed on bottom: rear fog lamps OFF	
	Vehicle raise/lower	Green	Pressed on top: vehicle raise, Pressed on bottom: vehicle lower	only use this button when vehicle is stopping
	Defroster	Yellow	Pressed on top: windscreen heater ON, windscreen heater OFF	
	Reading lamp	Green	Pressed on top: reading lamp ON, Pressed on bottom: reading lamp OFF	

Switch	Name	Color	Function	Notes
	horn	Green	Pressed on top: air horn is active, Pressed on bottom: electric horn is active	
	Engine idle	Green	Pressed on top: engine idle speed raise, Pressed on bottom: engine idle speed lower	adjust engine speed
	Front passenger door	Green	press button once to open front passenger door; press button again to close	
	Rear passenger door	Green	press button once to open passenger door; press button again to close	
	Electric curtain	Green	Pressed on top: to raise curtain; Pressed on bottom: to lower curtain	
	TV	green	Pressed on top: TV is turned ON, Pressed on bottom: TV is turned OFF	
	Reversal monitor	Green	Pressed on top: reversal monitor turned ON, Pressed on bottom: reversal monitor turned OFF	
	Rearview mirror defrost(preheating)	Yellow	Pressed on top: preheating ON, Pressed on bottom: preheating OFF	
	Diagnose	Green	press this button to make a diagnosis of engine, when engine indicate trouble	
	Disinfect	Green	Pressed on top: disinfection turned ON, Pressed on bottom: disinfection turned OFF	
	Cruise	Green	Pressed on top: cruise function is active, Pressed on bottom: cruise function isn't active	we advise clients not to use this switch
	Cruise setting	Green	cruise setting	we advise clients not to use this switch
	Emergency time-delay parking	Red	Pressed on top: Emergency time-delay parking function is active, Pressed on bottom: Emergency time-delay parking function isn't active	only used when engine failure

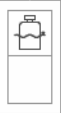
Switch	Name	Color	Function	Notes
	Exterior guidepost	Red	Pressed on top: turn on guidepost lamp; Pressed on bottom: turn off guidepost lamp	
	Assistant brake	Yellow	Pressed on top: turn on assistant brake; Pressed on bottom: to turn it off	only switch on when vehicle need park
	Vehicle level reset	Green	Pressed on top: vehicle level reset	
	Emergency power	Red	Pressed on top: emergency power turned ON Pressed on bottom: emergency power is turned OFF	
	Toilet power switch	Green	Pressed on top: Toilet power is turned ON, Pressed on bottom: Toilet power is turned OFF	
	Heater switch	Red	Pressed on top: to turn on heater ; Pressed on bottom: to turn it off	
	TV overturn switch	Green	Pressed on top: expand the TV, Pressed on bottom: collapse the TV	
	Fresh air switch	Green	Pressed on top: turn on the changing fresh air function; Pressed on bottom: turn off the changing fresh air function.	
	Electric driver window switch	Green	Pressed on top: the glass getting up; Pressed on bottom: the glass getting down.	
	Electric driver window defrosting switch	Yellow	Pressed on top: turn on defrosting function; Pressed on bottom: turn off defrosting function.	
	Rearview mirror defrosting switch		Pressed on top: turn on defrosting function; Pressed on bottom: turn off the defrosting function.	
	Left side bin gate	Green	Pressed on top: open the left side bin gate; Pressed on bottom: close the left side bin gate.	

Switch	Name	Color	Function	Notes
	Right side bin gate	Green	Pressed on top: open the right side bin gate; Pressed on bottom: close the right side bin gate.	
	Powerful/abstemious transfer switch		Pressed on top: turn on powerful function; Pressed on bottom: turn off abstemious function.	
	Electric sun blind	Green	Pressed on top: the sun blind getting down; Pressed on bottom: the sun blind getting up.	
	Driver seat lamp switch	Green	Pressed on top: turn on the driver seat lamp; Pressed on bottom: turn off the driver seat lamp.	
	Kneeling switch	Green	Pressed on top: turn on kneeling function; Pressed on bottom: turn off kneeling function.	
	Coin box switch	Green	Pressed on top: open the coin box; Pressed on bottom: turn off the coin box.	
	Turning lamp switch	Green	Pressed on top: turn on the turning lamps; Pressed on bottom: turn off the turning lamps.	
	ACU unlock switch	Green	Pressed on top: ACU unlock; Pressed on bottom: ACU lock.	For articulate plate only
	Inner guidepost switch	Green	Pressed on top: turn on the inner guidepost; Pressed on bottom: turn off the inner guidepost.	

Indicator lamp	Color	Function
	Red	passenger door open indicating
	Red	natural gas leakage indicating
	Red	front passenger door open indicate
	Red	rear passenger door open indicating
	Red	exit has been open indicating
		hollow plate
	Yellow	ECAS alarm indicating
	Red	ECAS fault indicating
	Red	gearbox fault warning indicating
	Green	retarder indicating
	yellow	Fuel filter seeper
		Hollow plate
	Yellow	Maintain waiting
	yellow	Start
	Red	Stop
	Yellow	Alarm
	Red	Water level
		hollow plate
	Green	WC
	Red	Service

Indicator lamp	Color	Function
	Red	Transmission oil temperature too high
	Red	Transmission fault
	White	Start-up waiting
	Yellow	Over emission
	Yellow	Kneeling lamp
	Green	Normal height

Air conditioner (KL-30Y)

Select key introduction:



Power key



Select ensure key



Air speed select key



Fresh air select key



Up key



Down key



Temperature display

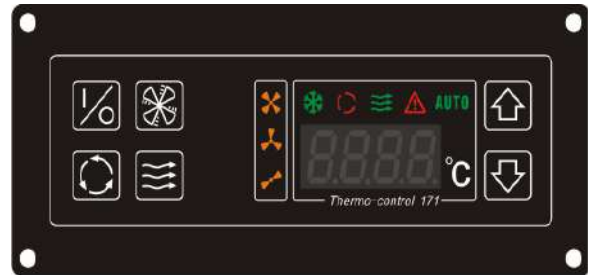

Indicator light introduction:



low air speed

midterm air speed

high air speed



Cooling

Setting Temp

Pressure alarm indicator

Fresh air

Control panel operation:

1) How to use the air conditioner

(1) Start the engine

(2) turn ON the cooling switch, push 

(3) set the suitable temperature—the setting temperature will be held automatically

(4) turn OFF the cooling switch, push  for one second.

(5) stop the unit

2) Temperature setting

COOLING—The system begins to cool if the set temperature is lower than the temperature inside the bus

——The system stops cooling if the set temperature is higher than (or equal to) the temperature inside the bus

3) Temperature controlling

For example: adjust the set temperature from 25°C to

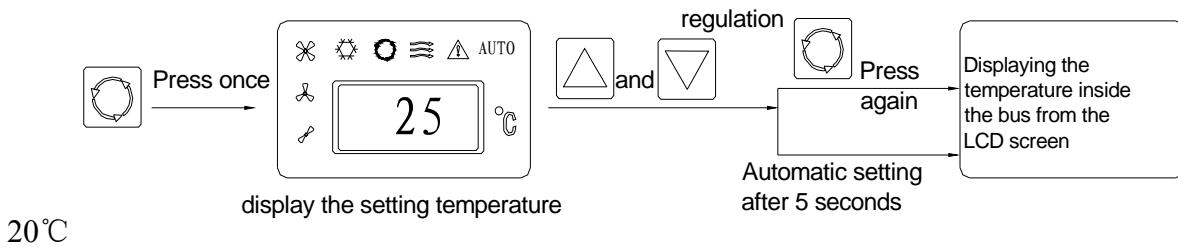

The lamp of setting the temperature will light up when pressing the button of . The setting temperature will be displayed on the LCD screen. Adjust the temperature with the button of and to 20°C. Press the button of after setting the temperature, the setting temperature light is off. Otherwise, the LCD screen will display the temperature inside the bus 5 seconds later.

Note:

- the scope of setting temperature is from 15.0°C to 40.0°C
- the scope of displayed temperature is from -40.0°C to 40.0°C

4) Flow rate selection

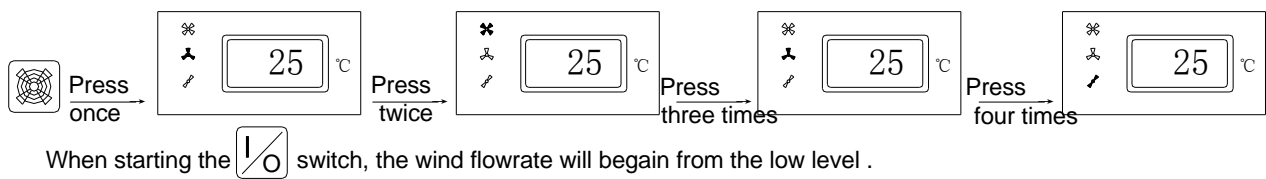

5) Automatic flow rate selection

Press the and for 2 seconds then the unit will begin automatic flow rate selection, it will change the flow rate depends on the air return temperature. Then the indication light at the above right light . The flow selection is not work at the moment. Press the and button at the same time for 2 seconds can stop the automatic flow rate selection and the indicator light will stop and the air flow rate selection will recover.

6) Working conditions of the automatic flow rate selection

- High air flow rate: The temperature of air-return inside the bus is higher than 26.5°C (including 26.5°C).
- Medium air flow rate: the temperature of air-return inside the bus is 24.5—26°C.

Low air flow rate: the temperature of air-return inside the bus is lower than 24°C (including 24°C).

When switching air flow rate by different temperature, the switching confirm time is 30 seconds.

7) Temperature control method

Using ON/OFF mode: the temperature controlling precision (DIF) is 2°C, (FIX SETTING)

For example: the temperature controlling precision (DIF) is 2°C, The setting temperature is 25°C.

When the bus inside temperature is 30°C:

The cooling system will be stop (OFF) when the temperature reaching 25°C.

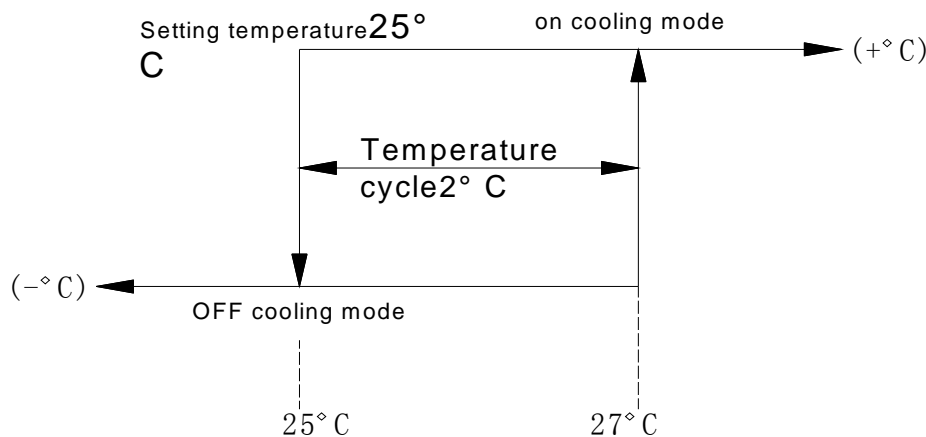

The cooling system will be start (ON) for cooling (COOLING) when the temperature is over 27°C. The cooling delay time is 10 seconds when it's at the first starting, after this the interval time is 30 seconds.



8) Strong cooling



This function of maintenance is used in the season which the air conditioner does not use (over 2°C inside of bus). The goal is provide the lubricant to the shaft sealing ring by the pressure of the working compressor. Normally it works 10 minutes and once or twice every month.

9) Operation of strong cooling

When the temperature setting is 15°C and press the button  for 5 seconds, the temperature setting indicator 2°C. After the strong cooling work for few seconds, the cooling  light up. The temperature setting turn back to 22°C when one cooling cycle finish.

10) Defrosting temperature

The LCD screen will display the defrosting temperature 1 or defrosting temperature 2 by

pressing the button of  or .

11) The part below the LCD screen will flash when the defrosting function working.

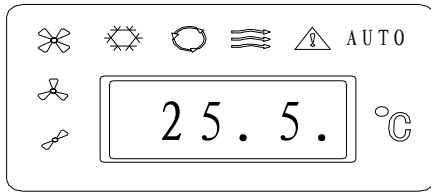

Display the defrosting temperature





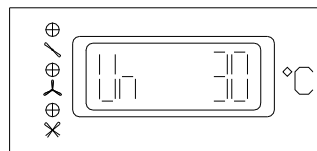

Note:

- (1) **The compressor (COMP) and the condenser (COND) fan will stop working and the evaporate (EVA) fan will run normally when the system defrosting.**
- (2) **The operation of the defrosting is automatically Controlled. the defrosting operation begins to work when the temperature of the sensor is(ON) at -1°C and stops working (OFF) at 8°C.**

12) Set the fresh air vent function





The LCD screen will display the Vent open (Vn) and the

setting time when the button  pressed for 5 seconds. The button pressed again to show VF and the setting time. Adjust the setting time by pressing the button of  and  to the setting time within 1—60min. (Generally the setting time is 10 minutes) . Press the button  for the confirming of the time setting, or the system will confirm the setting time automatically in 5 seconds. Adjust the setting time by the button  and  within 1—60min when the LCD screen display VF and the setting time. (Generally the setting time is 30 minutes) . Press the button  for the confirming of the time setting or the system will confirm the setting time automatically after 5 seconds.

Note:



- Restart the (VENT) switch to carry out the new procedures after the setting.**
- Otherwise, the previous setting will be carried out again.**
- Only one parameter can be set for each time.**

13). check the power.

Press the  10 seconds, it shows the air conditioner voltage. Press the , it shows the

red line voltage of control panel. Press the , it shows the voltage of air conditioner generator (when the air conditioner is without generator, it only shows the red line voltage of control panel i.e. the voltage of vehicle generator.) If it isn't operation during this process, it will show the air return temperature after 5 seconds.

14), check and cleanup time

Press the  for 12 seconds, it shows the working time of air conditioner. During this process it isn't operation. After 5 seconds, it shows the air return inlet temperature. When the air conditioner is working, press the  and  for 2 seconds at the same time. It can be cleanup the time as 0.

Note:

the working time of air conditioner, it can be calculated the time as hours since the low flow rate is beginning. That can be added up every working time of turn off the unit and control panel power off. It also can check and clean up the working time at any alarm condition.

Pre-heater Operation (Webasto)

1. General

The standard digital timer enables you to preset the start of the heater operation up to 7 days in advance. It is possible to program 3 different starting times, only one of which can be activated.

The standard digital timer features a wakeup alarm function.

When the ignition switched on, the timer displays the current time and the day of the week.

When the heater is switched on, the display and the buttons are illuminated.

After the power supply has been connected, all symbols on the display will flash.

The current time and weekday must be set.

2. Operation

The timer can be operated in that all flashing symbols can be adjusted by means of the 10 and 9 buttons.

If the buttons are not pressed within 5 seconds, the time displayed will be stored.

If the 10 and 9 buttons are pressed for more than 2 seconds, the fast time-setting mode is activated.

If the ignition is switched off while the heater is operating in the continuous mode, the remaining operating time of 15 minutes is displayed and the heater continues to operate for this period of time.

3. Switch the heater on

Manually: by pressing the button 8 (continuous heating mode)

Automatically: by programming the heater starting time

4. Switch the heater off

Manually: by pressing the button 8

Automatically: after the programmed operating time has elapsed.

With the heater running: by programming the remaining operating time

5. Setting time/day of the week

Press the 6 button for more than 2 seconds-time of the day if flashing-and set the clock using the 9 and 10 buttons. Day of the week is flashing – adjust the day of the week.

6. Viewing the time

With the ignition switched off: press the 6 button.

7. Programming heater starting time:

Standard Timer

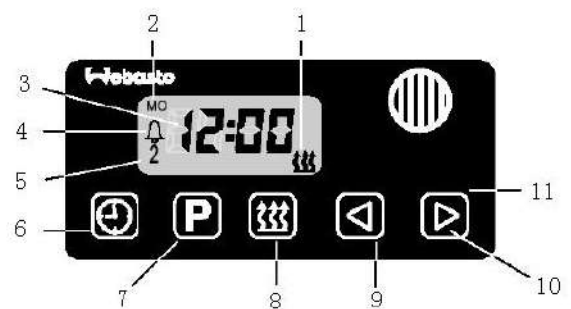

1. heater "on" indicator
2. day of the week
3. time display
4. memory location
5. alarm indicator
6. time
7. program selection
8. instant heating
9. reverse
10. forward
11. panel

Press the 7 button – the memory location is flashing – using the 9 and 10 buttons set start of the heater operating time. Day of the week is flashing- set the day of the week. By repeatedly pressing the 6 button, memory locations 2 and 3 can be programmed or the time display mode can be reached.

8. Recalling/erasing preset times

Repeatedly press the 6 button until the desired memory location is displayed. To erase the preset time, press the 7 button several times until the time of the day is displayed instead of the memory.

9. Programming duration of operating time The heater must be switched off. Press the 9 button for 3 seconds – operating time is flashing – and set the desired operating time (10 to 120 minutes) using the 9 and 10 buttons.

10. Setting the remaining operating time



Set the desired remaining operating time (1 to 120 minutes) using the 9 and 10 buttons. The remaining operating time refers to the time the heater still continues to remain in operation and the ignition switched off.

11. Setting the wakeup time

A wakeup time can only be programmed on the standard digital timer. The wakeup time is not bound to a specific day of the week.

Repeatedly press the 7 button until the bell symbol  appears on the display. Set the desired wakeup time using the 9 and 10 buttons. The alarm clock turns off after 5 minutes or when one of the buttons is pressed.

12. Recalling/erasing the wakeup time

Repeatedly press the 7 button until the bell symbol  appears on the display – read off wakeup time. To erase the wakeup time: press the 7 button until the bell symbol  is no longer visible on the display.

13. remote control

Possible by means of an optional external “instant heating” button

14. Vehicles with ADR equipment

On ADR vehicles it is not possible to program a preset starting time. The remaining time is shown on the display while the heater is in operation. The clock can be set. The alarm clock function can be programmed on the standard digital timer.

Transmission application (Voith)

Starting the engine

First apply the parking brake.

No button of the push-button switch may be depressed during starting. Bring all buttons into neutral position by depressing the button marked 'N': all buttons are released, the 'N'-button is illuminated.



Under certain conditions it may be possible to start the engine after pressing any button other than the 'N'-button. In that case, however, no gear will be engaged even if the push-button switch indicates this. Make sure you only start the engine after having pressed the 'N'-button.



Driving forward

If your vehicle is equipped with a safeguard against inadvertent gear engagement this facility must be operated first. For that purpose step onto the brake pedal.



Press button 'D' while the vehicle is at standstill and the engine idling.

When the brake is released now, the bus will start moving.
Note: If the vehicle fails to move off possible reasons may be:

- the accelerator was actuated while selecting a gear,
- the safeguard against inadvertent gear engagement was not released.



Please also consult the operating instructions of the vehicle.

When moving off on a gradient, step on the accelerator before releasing the brake in order to prevent the vehicle rolling back.

Note: Driving in the partial load range rather than at full throttle or kickdown mode will have a positive effect on fuel consumption.



Driving in kickdown mode

For higher acceleration, depress the accelerator beyond the full-throttle pressure point. This causes the transmission to change gears at a higher speed.

Note: Driving in kickdown mode will increase fuel consumption.



Driving with buttons

1, 2 or 3 (if available) pressed:

When the transmission hunts between two gears when driving uphill, press the button for the lower of the two gears. This will prevent engagement of the higher gear.



Hunting between gears	Pressing the button
4 - 3	3
3 - 2	2
2 - 1	1

Note: Driving with buttons 1, 2 or 3 pressed will increase fuel consumption.

Braking

With the DIWA transmission breaking is free of wear. Actuating the brake pedal or the manual switch for converter brake will apply the converter brake. Depressing the brake pedal further will apply the service brake.

Please note when braking on a slippery road: the converter brake only acts on the driven wheels.



On vehicles without ABS the converter brake should therefore be disabled when road conditions are poor (e. g. in ice or snow) in order to avoid rear wheel lock-up and a possible loss of control over the vehicle.

Switch off the converter brake via the converter brake switch, if available



In vehicles equipped with ABS the converter brake switch is mostly not available. The location of switch and its handling are described in the operating instructions of the vehicle.

Stopping

During short stops (e.g. traffic lights, bus stops) the selected button remains depressed and the vehicle is held by the vehicle wheel brake or the parking brake.



ANS-activation

Automatic Neutral at Standstill:

Conditions for activation of ANS :

- accelerator in idling position,
- brake signal,
- driving speed below 1 km/h,
- forward gear selected.

The power flow between engine and transmission is interrupted. This results in fuel savings.

Reversing

Press button 'R' while the vehicle is at standstill and the engine idling and - if available – the reverse gear inhibitor button. A change from 'Forward' to 'Reverse' or viceversa is only possible after operation of the 'N' button.



Never engage reverse gear when moving forward – danger of accident!

Parking

For longer stops or when switching off the engine, switch the transmission to neutral (button 'N') and apply the parking brake.



Open/close the passage door.

1. Before leaving the vehicle, press the button 1 of the door remote controller to close the door.



2. Use the key to lock the door. First insert key into the hole 3 and clockwise rotate key about 90°, then anticlockwise rotate handle 4, after that the door would be locked.



3. If need open the passage door, insert key into the hole 3 and clockwise rotate it about 90°, then clockwise rotate handle 4, follow press the button 2, after that the door would be opened.

Specification: For the king-long city bus, the method of open and close the passage door is different to above. Details please see the right drawing. The red button is close button; the green button is open button. This device usually located on the bin under the driver seat compartment. If need open or close the front passage door without remote controller, directly press the green button or red button. The middle passage door and the rear passage door of city bus controlled by the knob switch on driver zone.



Appedix:

The following are all type of door lock and door remote controller of King-Long.



Lock1



Lock 2



Lock 3



Door remote controller 1



Door remote controller 2

Door emergency switch

The model 1 door emergency switch is located on right underside of the ingress.

The model 2 door emergency switch is located on right upside of the door.

The model 3 door emergency switch is located inside the door pump cover which is on the top of the door.

Please rotate the switch and throw open the door in emergency.

Special attention: The door emergency switch is only used in the emergency mode. Please don't rotate the door emergency switch in driving for fear of danger.

Model 1



Model 2



Model 3



Adjustment of the driver's seat

The driver's seat may be made proper adjustment for the back and forth as well as the backrest angle according to requirement of the driver.

Handle 1 and Handle 2: cushion angle adjustment

Handle 3: back and forth adjustment

Handle 4: adjustment of the driver's weight

Left handle: backrest angle adjustment

Note: Number of handles varies with vehicle model

Attention!

The seat should not be adjusted during driving to ensure driving safety.



Horn button

It is on the steering wheel. The horn is hooting when pressing the button 1.

The type of steering wheel may vary with vehicle model. Please use the horn only when strictly necessary to warn other drivers and pedestrians.

Model 1



Model 2



Adjustment of the steering wheel

Pull-up the loosening handle 1 or rotate the loosening button 2. Adjust the height and the inclination of the steering wheel to the desired position. After adjusting, press the regulating handle or button down to lock the steering column.

Note: Number of handles varies with vehicle model

Attention!

Adjust the steering wheel only when the vehicle is stopped and the parking brake is on.

After adjusting, press the regulating handle or button down to lock the steering column.

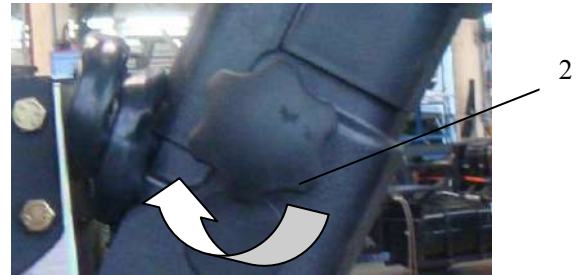
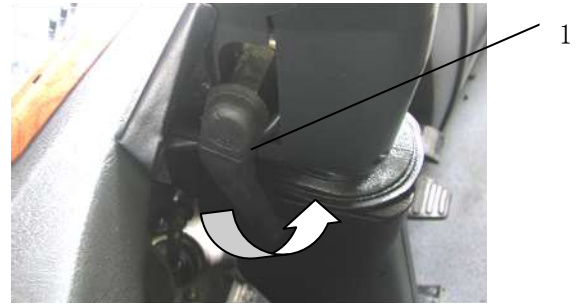

Ignition switch

Position of the ignition key is shown in fig.1.

"K" KEY: for inserting and drawing out position of the startup key

1."L" LOCK: Insert or remove the key in this position.

2."A" ACC: Power supply of the instrument is switched on

3."O" ON: Normal driving position

4."S" START: Initiating position of the engine, and the key may rebound to the "ON" position automatically after the startup.

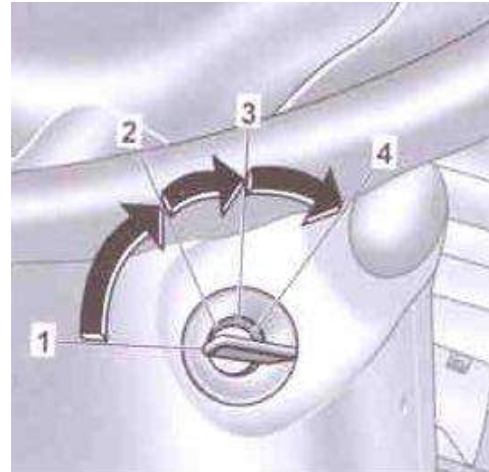

Before starting the engine, turn the key to the “ACC” position and then to the “ON” position. At this point, three lights (red, yellow and green) on the dashboard will come on. Wait for the lights to go out completely before you start the engine. However, make sure that all of the self-check lights have gone out completely before starting the engine. Allow the engine to run at idle speed for three to five minutes after it has been started; but never let it run for more than 10 minutes at idle speed. If the vehicle does not move, increase the fuel to the throttle modestly to increase the rotational speed of the engine a little; this will also prevent the early wear and tear of the engine. Allow the engine to run at idle speed for three to five minutes before turning it off.



Note:

1. Turn the ignition key to the OFF position after the engine has been turned off and has stopped running.
2. If the first attempt to start the engine is not successful, please wait two minutes before trying again.
3. If the engine fails to start after three attempts, check the fuel supply system. If the vehicle runs on natural gas, check the gas supply system.

Attention!

1. Do not remove the ignition key while the vehicle is in movement. And the ignition key should be turned to the LOCK position only after the engine shut down.
2. If engine can not start successfully for the first time, try again after 2 minutes. Please check the fuel supply system if the engine can not start for the third time.
3. When leaving the vehicle, even for a short period, take the key out to avoid operation of the vehicle by children or unauthorized persons.

Lamplight operating handles

The lamplight operating handle is located on right underside of the steering wheel, which control the front small light, headlamp, headlamp dimming, left and right steering by two different motion modes

OFF Indicating that the headlamp and the small lamp are all off.



Is the small lamp indication. The small lamp, the instrument light and the side indicator lamp will all be turned on when clock wisely rotating the handle to position of this identification.



Is the headlamp indication. The headlamp, small lamp, meter lamp and width lamp will all be turned on when continuously clockwise rotating the handle to position of this identification.



Is the turning indication. By back and forth motions of the operating handle may control the left and right turning lamp and that on the dashboard.



Is dimming indication. Uplifting the operating handle gently may actuate the headlamp dimming.

Note:

It's important to dip the lights promptly when approaching an upcoming vehicle in order to avoid dazzling its driver with the high beam of the headlight.

Model 1



Model 2



Model 3



Model 4



Wiper operating handle

The wiper operating handle is located on right underside of the steering wheel. (model 1~3)

OFF Out of work

INT interval wiper operation step

LO Slow wiping

HI Quick wiping

The wiper operating handle is located on left underside of the steering wheel. (model 4)

Rotary handle

0 Out of work

J interval wiper operation step

1 low speed wiper operation step

2 HI high speed wiper operation step

The wiper may spray water by pressing the end of the handle.

The wiper may spray water by pressing the end of the handle. The shifts of the retarder may be converted by back and forth motion of the handle.

Note: do not actuate the wiper without water; press the washer button as needed, then actuate the wiper.

Model 1 (with retarder)



Model 2 (with exhaust brake)



Model 3



Model 4



Passenger control panel instruction

1. air outlet
2. service button
3. reading lamp button
4. lamp
5. loudhailer
6. stop button

Model 1

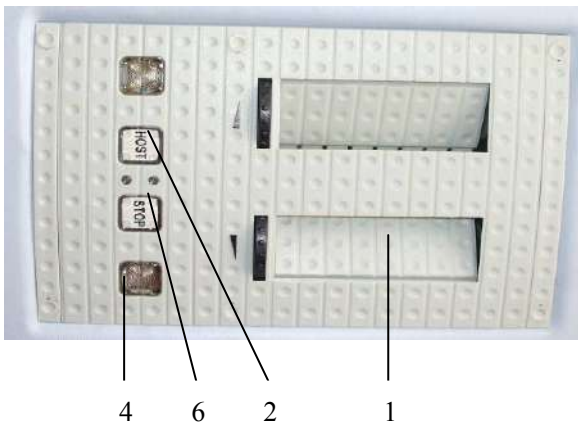

Model 2

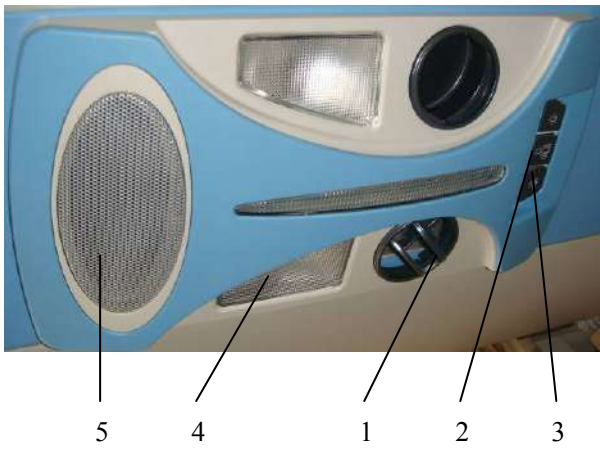

Model 3

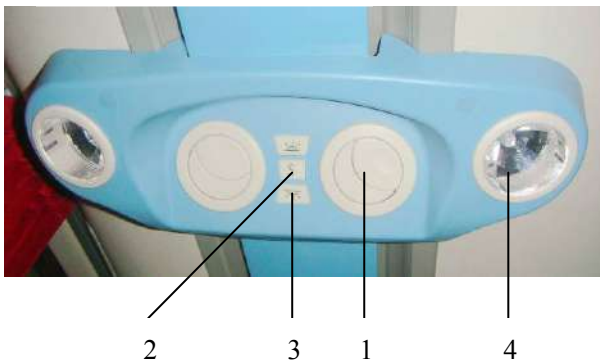

Model 4

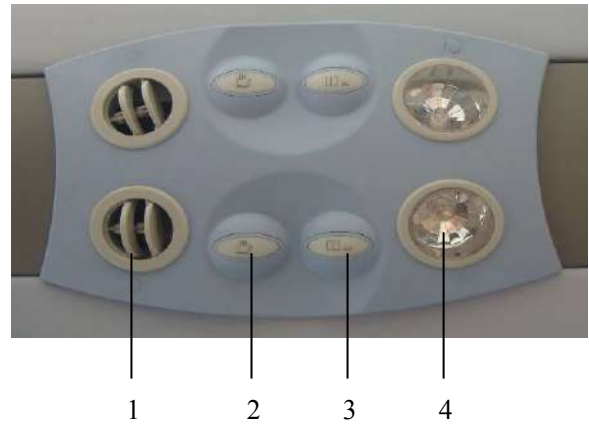

Model 5

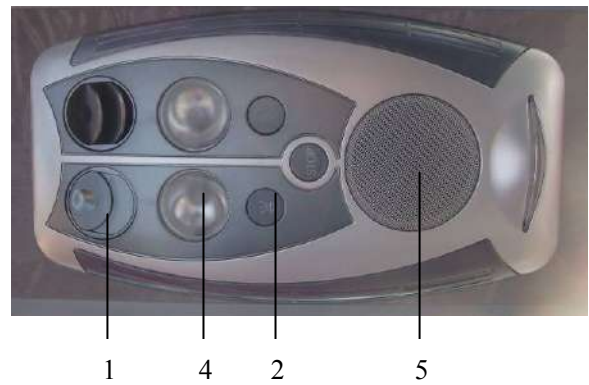

Model 6



Safety hatch

The safety hatch is located on scaffold of the vehicle. Please open the safety hatch according to the above diagrammatic representation and illustration for escaping in case of danger.

Model 1



Model 2



Model 3



Safety hammer

The safety hammer is located on the side window.
Please take down the safety hammer and break open
the safety window for escaping in case of danger.

Model 1



Model 2



VDO module

Installation position

1. Central control electric box



installed the step wall behind of driver seat

2. Body module 1



installed the step wall behind of driver seat

(front control unit)

3. Body module 2



installed in the air duct over the RH /FR passenger seats

(ceiling control unit)



4.Body module 3-4

installed in cabin box at the RH RR

(middle &rear control unit)



5.Retarder control unit

installed the step wall behind of driver seat.



6.WABCO ABS control unit

installed on the wall of luggage cabin.



7.Instrument control unit

installed in dash board.

VDO Module function description.

Part A

Name: ZR 32-A

Function description:

It is the central computer of VDO bus CAN system. ZR 32-A can receive, transmit and deal with message from power train, cluster and nodes. It also has a few of input and output pins.



Part B

Name: MUX2-B

Function description:

It is the one node of four VDO nodes in our vehicle. It collects input signals of digital and analog and to control the electric devices, lights, etc.



Part C

Name: WABCO ABS ECU

Function description:

ECU receive and deal with the signal from the ABS sensor, then transmit to ABS magnetic valve. ABS magnetic valve control the brake pressure by this signal.



Part D

Name: DC/DC convertor

Function description:

Change the whole vehicle voltage 24V into 12V for the cigarette lighting. There are two convertors for two cigarette lighters .



Part E

There are nine relays and some fuses. The relays are horn relay, wiper relay, ON electric power



relay, ACC electric power relay, air condition relay and four UPL system's relay. Their names have been marked on the wire. The capacity and the name of fuses also could be found on the fuse box cover or the King Long Instrument Wiring Harness.

Switch control box (Model: CQ2025)

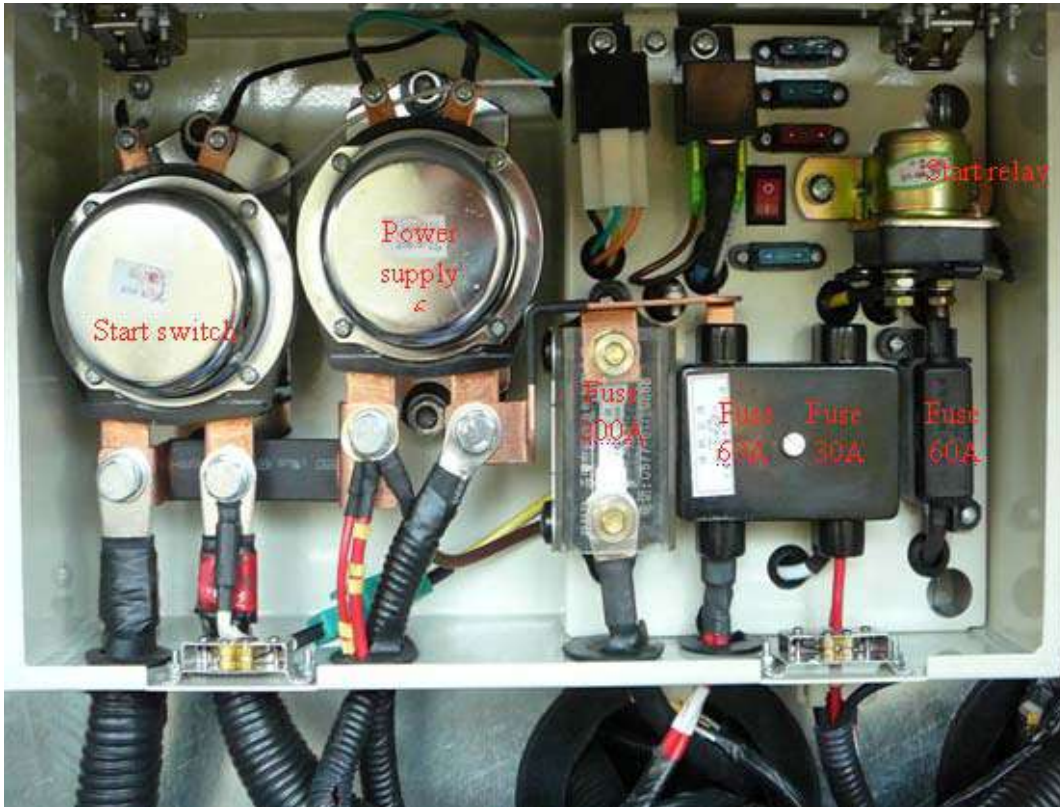

CQ2025 A wiring diagram (Printed on opposite cover of the switch control box)

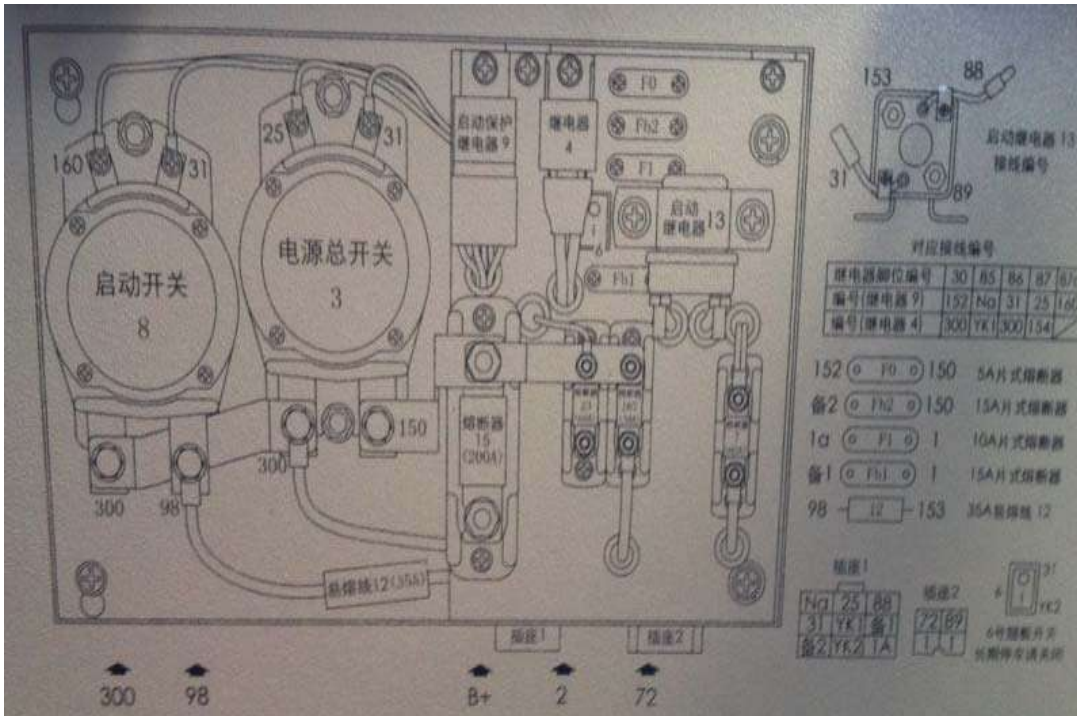

The fan angle transmission mechanism

This system has two benefits: first, it reduces transmission noise, and second, it improves cooling efficiency and requires only one belt instead of two.



Preparatives for vehicle operation start up:

Check daily, before turning engine on:

1. Check oil level of the engine

The warning “Engine oil pressure” is displayed as a signal item on the combination instrument when the oil pressure is too low, the alarm buzzer sounds, the warning light STOP comes on, stop the engine and check engine oil level at the dipstick. Provide immediately for the oil replenishment to its correct level.

The oil level should always be checked with the vehicle parked on level ground, before starting the engine up, or at least 5 minutes after having shut it down.

Open the engine compartment hood.

Take out the oil dipstick, and clean it with a clean cloth without loose threads, and put it back into its place fitting it in completely.

Once again pull out the dipstick and check the oil level.

- a. The oil should not exceed the maximum level.. drain the excess.
- b. If the oil is at operational level, do not add more oil to the crankcase.
- c. If the oil is at or below the minimum level, add the same type and brand of oil to the crankcase as that already there, until reaching the maximum level..

After the checking, replace and fit the dipstick completely back into its place.

If the oil level is checked after the engine has been run for a period of time, then it should take at least five minutes before the measure to ensure the oil back flow to the oil sump in full.

Oil level dipstick



Oil inlet

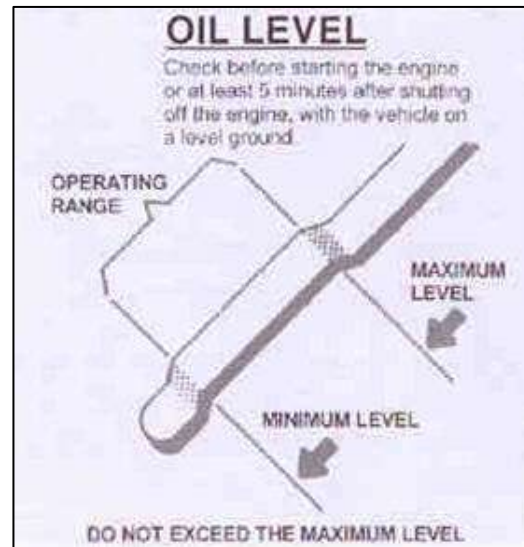

2 Check level of the coolant

The coolant level is automatically monitored.

If coolant level gets too low, the digital indicator displays a driver information on the combination instrument. In this case, park vehicle in a safe place as traffic conditions permit, stop engine and visually check the coolant level.

Check the coolant level only when the engine doesn't work and its temperature is below 50°C.

The anti-freezing rust-inhibiting engine coolant level can be observed from the observe pipe.

The coolant level should be between the maximum level (MAX.) and minimum (MIN.) level indicators in the compensation tank.

If it is necessary to add coolant to the system:

- Place the heating system command in the position of maximum heating potency.
- Add the coolant to the system up until the maximum level indication. Only use coolant which is recommended.
- The compensation tank cover should not be opened when temperature of the coolant is still high to avoid being scalded Place the lid on the system and turn it to the limit.
- Pressure valve of the compensation tank should be opened when adding the coolant to eliminate air in coolant pipeline of the diesel engine.
- Run the engine for a short time at varied rotations.
- Stop the engine and check the coolant level.

If necessary add more coolant to the system

Anti-freeze and antirust solution (mixture of glycol and water) should be added to cooling system from time to time to avoid sediment, frost, oxidation and increase boiling point.

Note: When adding coolant, please choose the same model to avoid sediment. If coolant is degenerative, replace it immediately.

Coolant specification as shown below: users should choose products produced by normal factories according to requirement

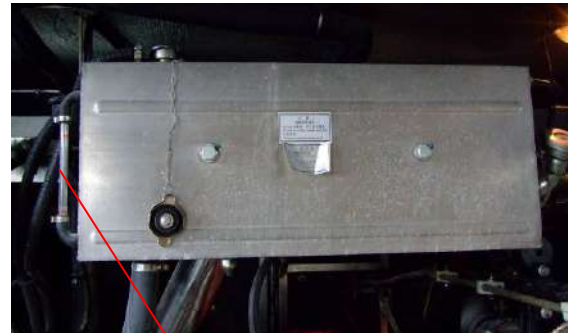

Observe pipe



Observe pipe



3 Fuel pre-filter with water separator (drain accumulated water)

Draining accumulated water

On a daily basis, check the lower cup of the water separator. If there is water in the cup, unscrew the draining plug one or two turns, to drain the accumulated water.

After draining the water, tighten the draining plug correctly.

When the accumulation of impurities in the lower cup is noticed, take the vehicle to a workshop to carry out its cleaning.

Changing the fuel pre-filtering element

The fuel filtering element should be changed periodically, at the intervals recommended in the maintenance manual. If however, the filtering element is easily saturated needing substitution at very short intervals, this is an indication of the accumulation of impurities in the interior of the fuel tank, and the cleaning of the latter should be carried out.

In order to change the fuel filter element, take the vehicle to a Dealer or a King-Long Workshop.

Fuel system discharge

Activate the manual pump until feeling resistance on pumping.

Start up the engine without accelerating. If the engine does not start running in 20 seconds, interrupt the startup and wait at least one minute before trying again.

If the engine insists on not working, repeat the discharge operation.

Leave the engine running for about a minute to completely eliminate the air from the system by way of the auto-discharge system.

In order to reduce environment pollution problems, do not drain the residues accumulated in the water separator directly into Nature (rivers, lakes or soil). The drained residues should be collected in appropriate containers and taken to receiving centers to have proper final destination (see local legislation).

Model for Euro II



Release valve



Manual pump

Model for Euro III IV



4. Fuel level

Turn the ignition key to drive position (on).

Check the fuel level on the indicator. If necessary, fill up the fuel tank. (but direct viewing by open the tank cover is preferred).

Eliminate deposit water in diesel filter in time and check fuel pipe for no leakage. Ensure sealing performance of fuel tank and before opening fuel tank, wipe up clay and dirt.

Before filling up, shut down engine.

Do not drive vehicle to empty tank. When the level indicator is on the red bar, refuel the vehicle to avoid air from entering the fuel system.

Fill the tank only with good quality fuel free of contaminants. The fuel might as well be filled up when running in the humid area to avoid inner rustiness.



5. Vehicle lighting, intermittent lights and brake lights

Check all instruments and indicator lamps for normal, especially the head lamp, the turning lamp, the brake lamp, the reversing lamp and the danger alarm lamp.

Check the bulb and the switch for their damage. To carry out the lamp substitution, hands should be very clean. If possible handle new lamps with tissue paper.

Clean the external of all instruments and indicator lamps to ensure clear indication.

Attention!

The traffic laws regulate the location, lighting intensity, and color of the lenses and the quantity of lanterns for each type of vehicle. The King-Long vehicles leave the factory in strict obedience of these specifications. Traffic safety depends on these factors; therefore do not change the place of the lanterns. Substitute the damaged lanterns only for other original ones. Remember that a change of lantern colors can confuse other motorists and result in serious accidents. Avoid unnecessary lantern adaptations. When substituting lamps, use the same type and potency as the original lamps. Do not carry out any lamp adaptation in the headlights, as this will affect their adjustment and performance, putting the vehicle traffic safety at risk.

On a regular basis revise the illumination system, keeping it always in perfect working conditions.

6. Check the level of AdBlue and the daily maintenance of SCR system

(1) Check the level of AdBlue.

When the vehicle key rotate the ON position, the LED screen of combination instrument will display the remain volume of the AdBlue, please see the right diagram.

The volume of AdBlue

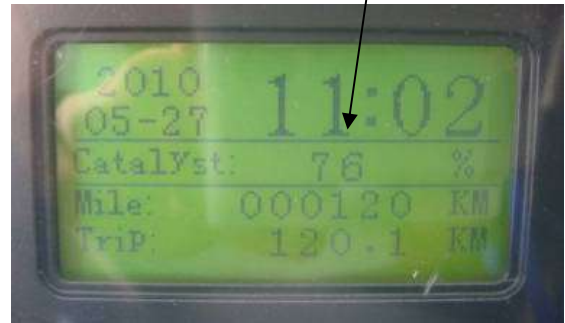

The AdBlue consumption is 5 percent of the fuel consumption. If the remain volume of AdBlue is less than 12%, the lamp 1 will flash and you need add AdBlue. If the remain volume of AdBlue is less than 6%, this lamp will light and the power of engine will be declined forcibly. This will cause the emission substandard and it is not good to engine.



(2) The daily maintenance of SCR system



Please add the AdBlue when it is insufficiency. Ensure the AdBlue meet the requirement. Check the SCR system is well enough and has no leaking before driving. There is obvious add mark in AdBlue tank. If add substandard AdBlue, must stop the vehicle right now and clean the AdBlue tank, re-filling the qualified AdBlue. The air filter should be clean and replace regularly.

Special attention:

If the AdBlue spill in skin, mild irritation may occur. Wash off with soap and water. If the AdBlue spill in eye, irrigate eyes with large amount of water. The AdBlue is Non-combustible, if heated water evaporates and ammonia will be released.

7. Drain water in air tank

Open the water drain valve of air tank to drain oily water fully. If too much oily water is bled, check to see if desiccant needs to be replaced in air drier. (This may be avoided when adopting the automatic drain valve but it should be checked every two weeks)

Check daily after turning engine on:

1. engine oil pressure

Run the engine.

The information on engine oil pressure can be requested through the driver information digital display.

If the oil pressure is too low, the oil pressure is automatically shown on the combination instrument.

Indication of the oil gauge will show a high value after the cold start of the engine and then it should be kept within the range of 0.3-0.5Mpa (3- 5kg/cm²) along with the increment of the oil temperature as well as the normal engine speed.

2. Pneumatic pressure

The air pressure gauge indicates the reserve pressure individually for the front and rear service brake circuits.

The reserve air pressure in each brake circuit must be sufficient for the correct operation of the brake system.

The STOP warning light comes on in case of low brake pressure in the service brake or parking brake circuits.

Attention!

If the driver information indicator displays the warning “brake pressure” and the STOP warning light comes on with the engine running, it will be an indication that the air pressure is excessively low. Do not drive the vehicle if the air pressure gauge displays low air pressure in one or both brake circuits, as the service brake could fail resulting in serious accident.

3. Tachometer working order

Indications on tachometer scale:

- a. Green zone – operating range of maximum performance
- b. Yellow zone –
- c. Red zone – engine overspeed range (risk of immediate engine damage)



Always observe tachometer while driving the vehicle.

Whenever possible keep engine running within the economical range.

On downgrade, select an adequate gearbox speed ratio and monitor vehicle speed to avoid engine operating in the danger range (red zone).

When the exhaust-brake is being operated on down grades, select an adequate gearbox speed ratio to keep engine speed within efficient exhaust-brake operation (yellow) .

Always avoid engine over revving (red zone), as engine operation in this speed range can end up the engine damage immediately or will seriously jeopardize its durability.

The yellow range with red reticle can be used occasionally when the exhaust-brake needs to be used at its efficiency limit, however, at risk of engine durability. Therefore, do not operate in this range in a normal or usual way.

4. Steering play

Steering wheel play

Run the engine at idle gear and straighten the front wheels forwards.

Turn the steering wheel alternatively to the right and to the left.

The steering play (free movement of the steering wheel) is measured on the perimeter of the steering wheel and should be between 20 and 30 mm.



Control periodically, at least once a week:

1. Check tire for abrasion and pressure and tire nut for fixture

The vehicle's safety and performance depend considerably on the state of the tires, reason why they should be checked daily.

Before driving a vehicle, check charging pressure of tire for normal, tire for damage, tire nut for fixture.

Note: At initial 50km, please tighten tire nuts of new vehicle to specified torque in appendix.

Tire pressure

Keep the tires always correctly calibrated. The inflation pressure should be checked with the tires cold at least once a week.

After driving the vehicle for some time, the tires heat and in consequence of the heat, the inflation pressure increases. Never, under any circumstance, empty heated tires to reestablish the recommended inflation pressure.

The pressure difference between the assemble tires on the same axle should not be superior to 0.1 bar.

Wheel hubs

Keep them always clean, eliminating eventual mud or other dirt adherence. Substitute the damaged and/or deformed hubs. The utilization of refurbished hubs is not recommended.

Wheel nut

Without fail re-tighten the wheel fastening nuts of new vehicles after running 50km.

The wheel fastening nuts should be retightened, crosswise, in turns, observing the recommended tightening torque according to the type of fastening nut. If a torque meter is not available, tighten the nuts strongly, using the vehicle tools without additional levers.

2. Air cleaner (activate the dust discharge valve to loosen accumulated dust)

The maintenance of the air cleaner is made up of the substitution of the filtering elements and should be done only when the maintenance indicator indicates the saturation of the element.

The cleaning of the main and safety filtering elements is not recommended. The re-utilization of the filtering elements can result in deficient filtering of the air and cause serious damage to the engine.

When washing the engine, conveniently protect the air inlet with a plastic or similar material to avoid the infiltration of water to the air filtering element. After washing the engine, remove the protection from the air inlet.

Model I

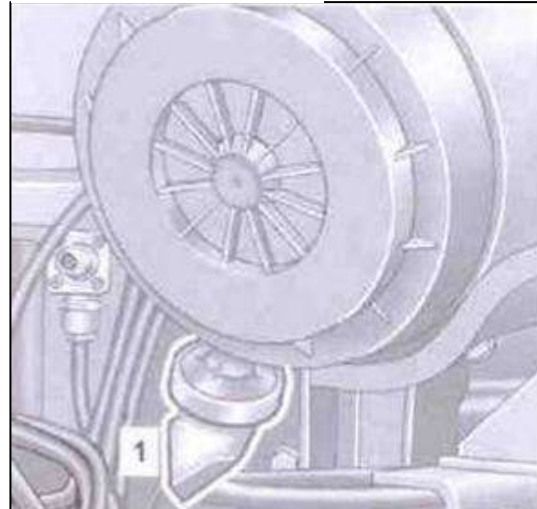

Periodically press the dust discharge valve with your hand, in order to incomplete the dust which possibly be caught in the internal part maintaining them clear. At the same time, check clip connecting rubber hose of air intake system with steel tube in case of dust entering air intake system due to looseness and decrease in engine life.

The air cleaner restriction is electronically controlled. If the indication of saturated air cleaner appears in the display of digital indicator in combination instrument, send the vehicle to a King-Long Dealer or authorized workshop to inspect and clean the air intake system and substitute the main filtering element.

Model II

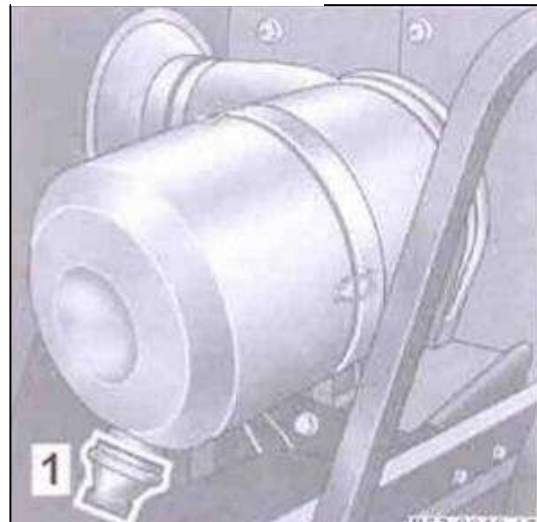

1 automatic dust discharge valve

Indication

The main filtering element of the air filter should be substitutes after maximum 2 years use.

The safety filtering element (optional) should be changed at every third main filtering element substitution, or after maximum 2 years of use.

3. General leakages (water, oil, fluids and fuel)

Check the engine, the transmission, the driving axle, the steering system, the cooling system and the oil pipeline, the air pipeline of the complete vehicle for their leakage.

4. Fastening and state of seat belts

Check buckle of the safety belt of the driver seat for normal and ensure for its lockup under the following situations when fastening the safety belt.

- The body dashes forward all of a sudden;
- The vehicle makes an emergency braking or an abrupt acceleration;

5. Check emergency devices and driver's tools

Such as extinguisher, crosstie for blocking vehicle, emergency hammer, jack and etc..

Fire extinguisher:

The pulse super-micro powder fire extinguisher is fixed in the engine compartment, when the compartment is on fire, the fire extinguisher activate automatically or is active by manual work to eradicate the fire

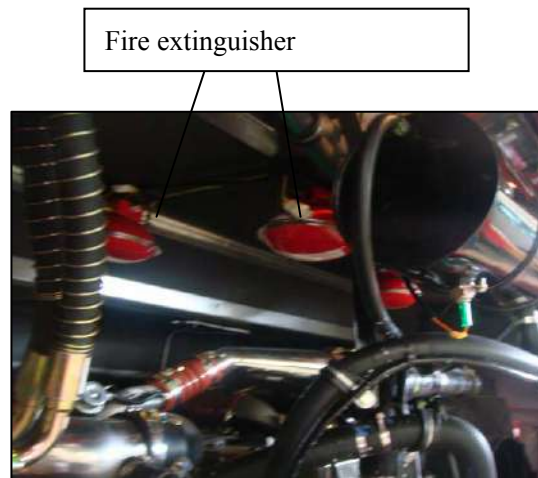

The fire button is usually located at auxiliary instrument desk in the driver compartment where people could operate it easily.

Operation: 1. When the engine compartment caught fire, the driver should stop vehicle and switch off engine immediately, open the fire button cover, and press the fire button, start-up fire extinguisher



2. Fire extinguisher may start-up automatically when it catches fire or its temperature arrives at **170°C**.

Important hint:

1. Fire extinguisher can be used for one time only, DO NOT press the fire button except for emergency condition.
2. The fire extinguisher can not start-up by press the fire button manually if the vehicle battery is dead or power turn off.
3. If the vehicle needs to be repaired, you could take away the anode and the cathode. And put them back after the reparation completed.

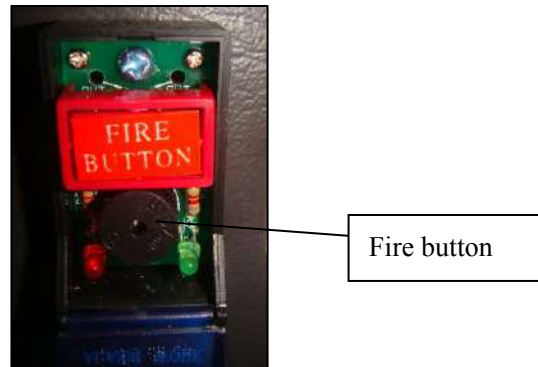

Inner fire extinguisher is fixed under the passenger's chair, when vehicle caught fire, stop vehicle and use the fire extinguisher.



6. Working order of windshield wipers and conditions of wiper blades and arms

Regularly check the windshield wiper blades for dirt or damage.
Press the lever to activate the windshield washer

Caution: Do not use the windshield wipers when the windshield is dry. Before activating the wipers, push the head of the wiper lever inward to spray detergent onto the windshield.

Check surplus of detergent

Stop vehicle on a flat road, open side cover of instrument desk.
Container of detergent is located inside instrument desk. If detergent is insufficient, add.

Add the clean water into the tank for windshield washer.

There are 2 kinds of water tank.

Model 1



Model 2



7. Electrical rearview mirror

Check, adjust and clean the rearview mirror.

Rearview mirror control button

Model 1

L: adjusting left rearview mirror.

R: adjusting right rearview mirror.

Mirror button: push down the arrow headed button to adjust the mirror for 4 directions.

Model 1



Model 2



Model 2

L: adjusting left rearview mirror.

R: adjusting right rearview mirror.

Mirror button: rotate the handle to adjust the mirror for 4 directions.

Model 3



Inspection every two weeks before and after driving

1. Power steering

Ensure that all the maintenance service jobs on the steering system be carried out at the intervals recommended in the maintenance manual to guaranty total efficiency and safety.

If any working abnormality in the steering is noticed, immediately supply the necessary repairs.

The habits of forcing the steering too far against wheel obstacles and of activating the steering while the vehicle is stopped are harmful to the steering system and should be avoided.

In emergencies, in the case of damage to the power steering system, the steering may be used without hydraulic help, however, in this condition there will be more steering wheel play and the steering will become noticeably “heavier”. Drive the vehicle very carefully and take it to an authorized King-Long Dealer or Workshop to re-establish the correct working order of the steering system.

Important: In the case of damage to the hydraulic steering pump or of the total loss of fluid from the hydraulic system, we recommend that the vehicle is not driven further than 50KM in order to avoid further damage to the steering system components.

Power steering fluid level

The power steering fluid level should be checked while the engine is running at idle and the fluid is hot. Run the engine at idle gear and turn the steering from side to side various times to heat the steering system fluid.

Check the level through the inspect window of the container.

Model 1



Model 2



Model 3



2. Clutch actuation system fluid level

Clutch

The clutch activating system can present irregular working due to the normal wear of the clutch disc. When suspecting that the clutch disc has reached the wear limit, take the vehicle to a King-Long authorized Dealer or Workshop to carry out the necessary repairs.

Clutch fluid level

The clutch oil tank is installed in the instrument desk.

Prevent the brake fluid used in the clutch activating system, from entering into contact with the vehicle's plastic components or painted surfaces. In the case of spilling or accidental dripping, immediately clean the affected surface with cold water to avoid damage to these components or to the vehicle paint.



The fluid level in the clutch activating system container should be between the maximum and minimum level indications. If there is a need to add fluid to the container, take the vehicle to check the impermeability of the hydraulic system. After eliminating any leaks, fill the container up to the maximum level and bleed the hydraulic system.

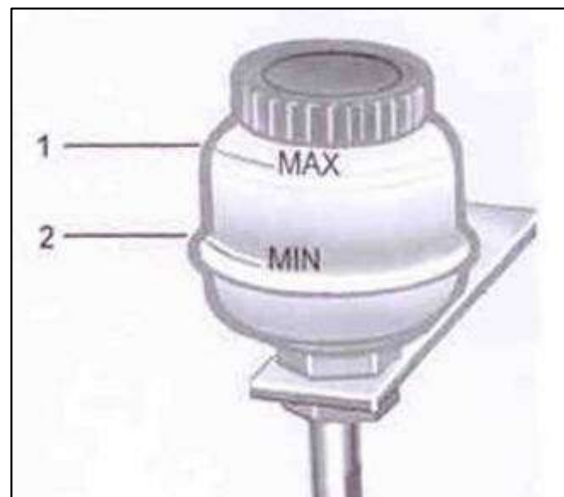

3. General state and tension of drive belts

Check the tension of engine belt, fan belt and compressor belt, if loose, tension it; if damaged, replace it. Do not start up the engine without the drive belts. In the case of one of the belts breaking, immediately stop the engine and have a new belt put in.

The checking, adjustment or substitution of the drive belts should be carried out with the engine shut down.

Check cross plane of the belt for no cracks. Crackle in the transverse direction (along the belt width direction) is acceptable while that in longitudinal direction and transverse crack cross is unacceptable. Please replace the strap in case of abrasion or chip dropping off.

Too tight or too loose belt would make against proper operation of engine. Press belt to check tension. Please refer to the manual book of engine assembly for detailed adjusting method and tension of belt.

The poli-V belts demand technical knowledge, therefore we recommend that this job, when necessary, be carried out at a King-Long authorized Dealer or Workshop.

Ventilator drive belts

If it is necessary to replace the ventilator drive belts in emergency situations, adjust their tension in such a way that upon pressing them with one's thumb in the middle of the distance between the pulleys, a deflection of approximately 20mm is observed. Loosen fastening nut of intermediary pulley before turning the adjusting bolt. After adjusting ventilator belt tension, tighten the fastening nut of intermediary pulley firmly.

Model 1:

Adjusting method of the single belt driving fan belt is shown in the figure

1. Check tension of belt
Apply force of 98N by the finger.
Strap sinkage between the crank pulley 1 and the fan pulley 2 should be 25 ~ 31mm.

2. Adjust tension of cone belt
Adjust bolt 3 until the tension is proper.
The max offset angle of the fan pully shaft should not exceed 5° , or else please replace it.

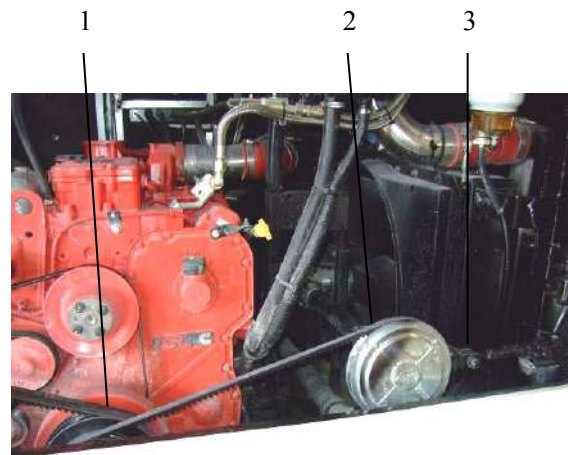

Model 2:

Adjusting method of the fan belt is shown in the figure

1. Check tension of belt
Apply force of 98N by the finger.
Strap sinkage between the crank pulley 4 and the counter pulley 2 should be 25 ~ 31mm.
Strap sinkage between the counter pulley 2 and the fan pulley 1 should be 7 ~ 8mm.
2. Adjust tension of cone belt
Adjust bolt 3 and counter pulley 2 up and down until the tension is proper.

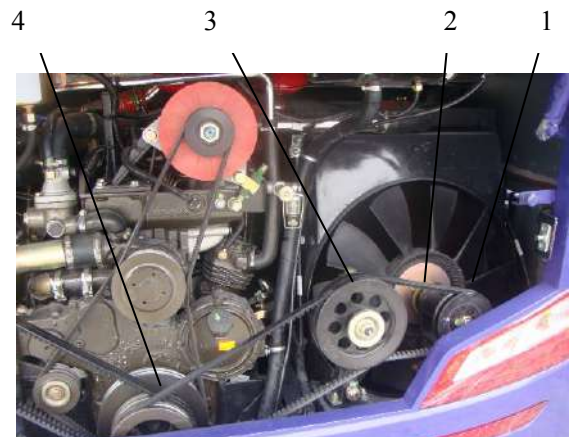

Air conditioning compressor drive belt

The pneumatic tensioning system keeps the tension of air conditioning compressor drive belt correctly adjusted and do not need to be adjusted periodically.

Adjusting method of the air conditioner belt is shown in the figure

1 Check tension of belt

Apply 98N force to belt with finger

Belt crank pulley 4 and middle pulley 2 should lower 10~15mm

2. Adjust tension of cone belt

Adjust nut 1 until tension of belt is proper

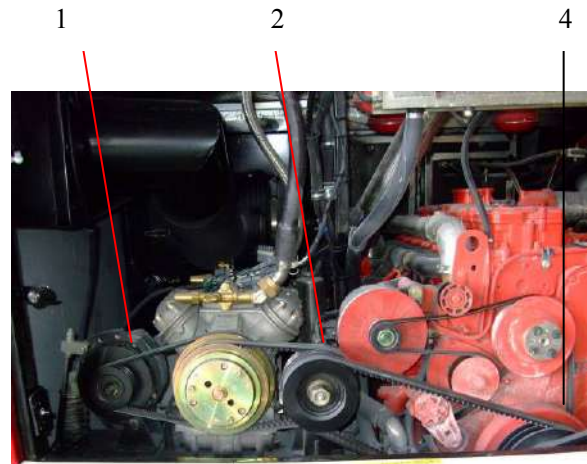

4. Check level of battery electrolyte

Open the battery cover to check level of electrolyte, if the level is lower than scale marked on the battery, please add it in time.

Note: During adding electrolyte, never start engine.

Battery

The battery compartment is located at the second compartment of left or right rear side.

- 1 battery
- 2 switch control box

To access the battery, open the switch control box panel.

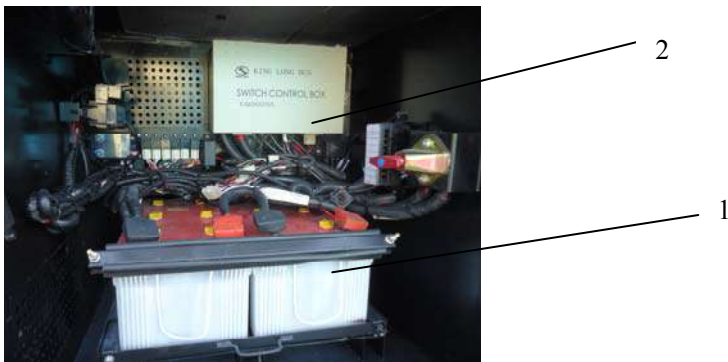

After the vehicle has been parked for the day, the main power switch should be turned off.

Cleaning

Keep the batteries always externally clean and the air vent unobstructed. Avoid battery contact with petroleum derived products.

Charge

Do not allow batteries to maintain a charge inferior to 75% of the total charge.
Do not submit the batteries to excessive overcharges or discharges.

Engine start up and shut down

Procedures for engine start up

Activate parking brake.

Place the gear box lever in neutral. Start up is not possible in gear position.

Turn the ignition key into gear position.

Start up without stepping on the accelerator. If the engine does not work after about 20 seconds, interrupt the start up process and wait at least 15 seconds before activating start again. To repeat start up, it is necessary to turn the key back to the off position.

Let the ignition key loose as soon as the engine starts running.

The motor rotation adjusts itself automatically in function of the coolant temperature.

Indication:

The start up process is automatically interrupted after 90 seconds of continuous activation. In this case, in order to repeat the start up activation, turn the ignition key back to the off position and wait at least 2 minutes.

After engine start up, the vehicle can be put immediately into operation.

Note:

- a. The engine should be running at low middle speed for 3-5 minutes on every day's first starting before the driving.
- b. Never race the engine without warming up. During cold start, increase engine speed slowly and do not make engine run at maximum speed until water temperature of engine reaches to 70°C. At any time, do not make engine run at high speed under no load.
- c. Never make engine run at idle speed for more than 10 minutes.
- d. The oil pressure should be displayed on the dashboard in 15 seconds after the engine is started, otherwise, stop engine to check..
- e. If parking brake indicator lights, indicating that parking brake has not be released.

Attention!

If on starting up the engine, the engine oil pressure indicator continues indicating low pressure, this means that the engine running order is in danger. Immediately shut down engine, find and correct the failure.

Engine shut down

Loosen accelerator pedal.

Place the gear box lever in neutral position and apply the parking brake.

Turn the ignition key to the off position, without accelerating.

Note: After engine runs at heavy loading, temperature of cooling water is higher than 90°C, so do not stop engine at once. The stalling should be made only after the engine has been running for a period of time and the water temperature lowed to the normal range. The parking brake is achieved by setting the hand brake handle on the control position after the stalling. The shift should be switched to the neutral position and power supply shut down. Please make necessary inspection of engine and then troubleshoot.

Cautions

Cautions during the winter operation

- ① Please add long life coolant to cooling system.
- ② After parking, please exhaust water in air tank in time.
- ③ Before winter comes, please check level of battery electrolyte, specific gravity and voltage.

Water used in the radiator must be soften.

Never make engine start without preheating or run with trouble. In the cold climate, do not start engine until preheat it with hot water or vapor to more than 30-40°C.

During driving downhill, do not place gearshift lever in neutral position to slip. Please apply exhaust brake or retarder.

Do not start vehicle until parking brake has been released

Engine start up and shut down in the engine compartment

Park the vehicle and activate the parking brake.
 Put the gear box lever or the automatic transmission selector in neutral (dead point).
 If the transmission is in gear position, the start up with in the engine compartment will not work.
 Turn the ignition key to gear position, without activating engine start up.

Engine start up

Press the start up switch (start) and activate the back cover course end switch bar in the engine compartment.
 Loosen the switches immediately the engine begins running.

When the engine is turned on by way of the start up switch in the engine compartment, this switch should be used as a manual accelerator.

With the engine compartment cover open, the start up by way of the ignition key is impossible.

Engine shut down:

Press the shut down switch (STOP).

To make the engine turn without starting up:

Press the engine start up and shut down buttons simultaneously.

Note: the final placement of the switches in the engine compartment is the responsibility of the vehicle body manufacturer.

Model 1



Model 2



Model 3



Starting the vehicle

The vehicle could only be started when braking system pressure has reached 5kg/cm^2 above and each instrument and indicator lamp is on the proper condition, and water outlet temperature exceeds 60°C as well as the parking brake has been released after the engine is started. Please make the startup in shift I.

On normal running condition:

- Pointer of oil gauge should be between 0.3 and 0.5Mpa ($3\text{-}5\text{kg/cm}^2$) .
- Pointer of water temperature gauge should be between 83°C and 95°C .
- Pointer of double-pointer barometer should be between 0.55 and 0.8 Mpa ($5.5\text{-}8\text{kg/cm}^2$)

After the vehicle starting, gear shifting should be made step by step and timely. The clutch pedal should not be released abruptly to impulse the starting when the vehicle is stuck in the mud or can not start on a spoil road.

The following problems should also be paid attention to during the driving

- ① If abnormal noise or odor occurs, please stop vehicle to check.
- ② Abrupt acceleration or emergency braking should be avoided as might.
- ③ Don't put foot on the clutch pedal during the driving.
- ④ Avoid engine overspeed. When driving long downhill, engine may overspeed easily after gearshift, at this time, pay attention to apply exhaust brake or retarder and driving brake to ensure engine run at specified speed.
- ⑤ During driving downhill, never stop engine, otherwise, resulting in de-pressure in brake pipeline and power steering gear failure.

During normal running condition, if the pointer of water temperature gauge is under the red sign that indicated the vehicle is on normal condition. if the pointer is on "H"

Parking the vehicle

The parking brake should be always applied when the vehicle is parked.

Additionally, in some countries, it is determined by law that a vehicle parked on a slope must have at least one of its wheels wedged, to prevent its accidental moving.

In this case, always keep an appropriate wedge available for this purpose aboard the vehicle.

When parking on public highways, obey the legal determinations as far as the use of parking lights or reflecting panels.

Parking brake handle

Pushing forward the brake handle is of driving state.

Pushing backward the brake handle is of parking state.

Always activate the parking brake when the vehicle is parked.

Besides activating the parking brake, when parking on upward or downward slopes, wedge one of the vehicle wheels to avoid the accidental moving of the vehicle.

Application

Attention!

On applying the parking brake, always check the locking of the lever in the total braking position, on the contrary, the lever may return automatically to the brake off position.

Pull back the parking brake valve lever in such a way that the lever is locked in total braking position. The parking brake warning light should light up.

Note:

In emergencies, with the possible failure of the service brake, the parking brake can be used as an emergency brake. In this case, slowly pull the parking brake lever allowing for a progressive braking without abruptly locking the wheels.

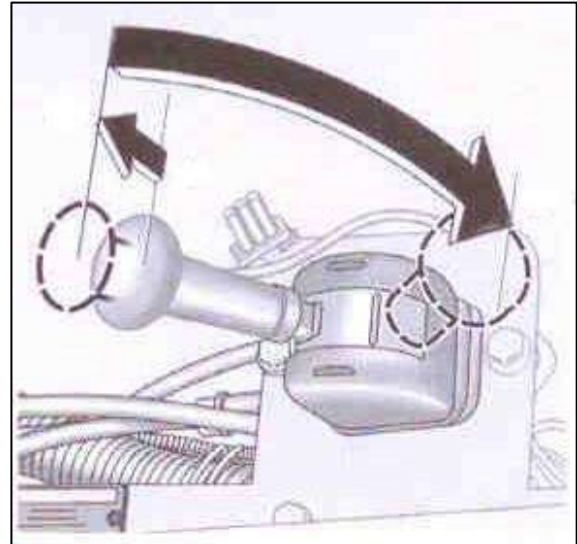

General knowledge

KingLong recommends that the bus be maintained according to the Maintenance Schedule in this section. Perform maintenance at whichever interval occurs first. At each scheduled maintenance interval, perform all previous maintenance checks they are due for scheduled maintenance.

King-long Bus General Maintenance

Please make periodic inspection and maintenance of bus according to the operation manual to ensure good status. During service, stop bus on a horizontal road and ensure bus steady and engine stopping. Make functional inspection and running test after each service.

Important Notice: If bus often runs under poor conditions (such as poor road surface, high dust concentration, frequent bump etc.), maintenance interval should be shortened. During adding lubricant, before replacing filter or repairing, clean the place around related parts carefully. Please add lubricant with clean containers.

Maintenance of engine and chassis assembly

- For the usage and maintenance of the engine, refer to relevant engine operation and maintenance manual.
- For maintenance of transmission and front-rear axle, please refer to relative users' guide.
- For use and maintenance of other parts of chassis, if without special user's guide or maintenance period, please refer to this manual for maintenance information.

Body maintenance

1. Keep body clean .Timely clean should be made after daily running and don't scrape body with tool in order to avoid paint scratch and damage of roll covering.
2. Sealing strips of doors and windows should be kept integrated. Make timely replacement if damaged.
3. Prohibit washing body paint with hot water, buck, kerosene and other liquid which has damage to oil paint.
4. Check connections between body and frame frequently. If find something abnormal, repair it in time.
5. Frequently check fasteners inside vehicle and tighten them in time.
6. Frequently check conditions of passenger door. If find something abnormal, do adjustment in time.
7. Frequently check conditions of all lamps. If find any damage, replace it in time.

ABS system maintenance and service:

1. Please cut off ECU control box to avoid the high voltage from outside to make damage to the ECU, when use the outer power supply to charge the battery.
2. When the vehicle need electric welding, cut off the ECU .never use the multimeter to measure the ECU box.
3. Inspect the engine voltage for stabilization periodically.

4. When maintain the brake shoe ,do not damage the ring gear and sensor, clean the ring gear and sensor at the same time. after maintenance ,do remember to put the sensor to the limited position along the ring gear direction.
5. Make sure that the power is in off position when remove and install the components, keep the components clean and dry.
6. Never change the fuse capability or connect the fuse in disorder.
7. Change the indicator in time when it doesn't work.
8. Do not brush the ECU with water when cleaning it.

Note: for details about the working theory of ABS and maintenance, please refer to the ABS instruction book which is offered by provider.

Because of different allocation requirements, some of the vehicle model may not be equipped with ABS system, please use correctly according to actual condition of vehicle.

Electrical system maintenance and service:

- (1) When battery is charged by external power supply, disconnect ECU control box to prevent outer high voltage damage ECU (electric control unit).
- (2) When vehicle needs to weld, disconnect ECU. Don't use multimeter to measure ECU control box.
- (3) Monitor voltage stability of generator regularly.
- (4) Parts dismantling must be carried out after electric has been shut off and should keep parts' cleanness and dry.
- (5) Don't change fuse capacity casually or bestride connect fuse.
- (6) When indicator doesn't work, replace it timely.
- (7) Don't use water to scour ECU when doing ECU cleanness.
- (8) Don't use multimeter to measure ECU.

Tire transposition

The tire may appear certain abrasion after period of running. The tire should be made transposition as the drawing below after every 8000 km to 10000 km running for proper use and prolonged tire life. Four-wheel locating condition should be checked, dynamic balance and tire transposition be made at once if there shows early and irregular abrasion of the tire.

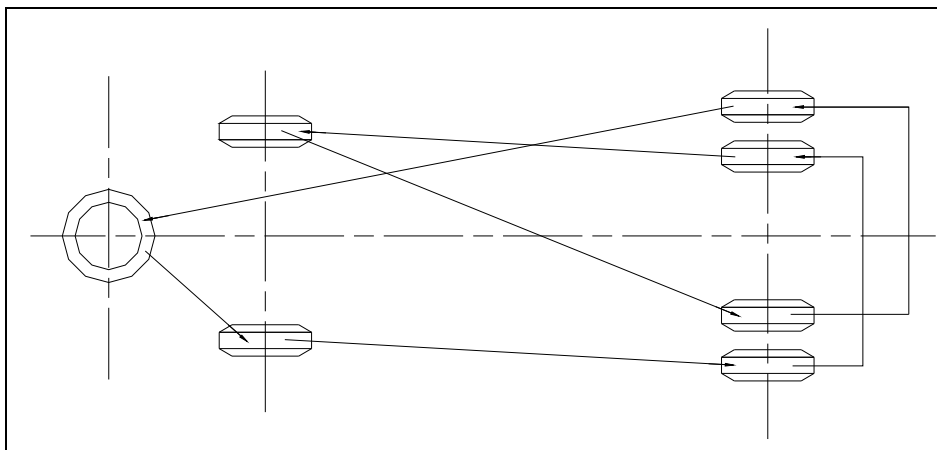

Tire transposition diagram (two axles)

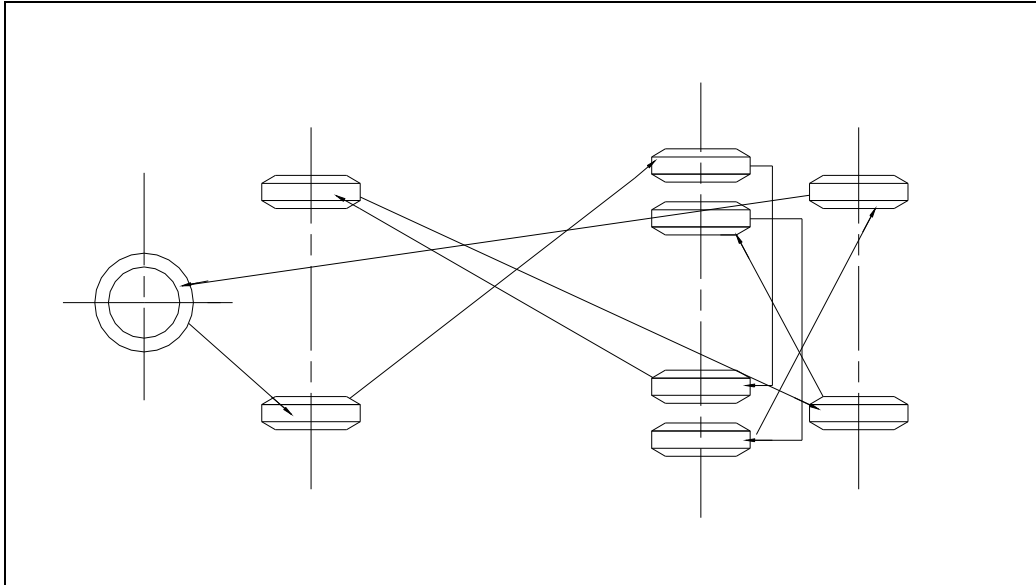

Tire transposition diagram(three axles)

Adjustment of the clutch pedal free play

Adjust clearance between push rod and piston of clutch master cylinder to 0.2-0.7mm. Loosen locknut and rotate push rod along the piston direction until it contacts the piston, and then turn back 1/7-1/2 circle. After adjustment, tighten the locknut and then adjust the length of clutch booster push rod to ensure 4-6mm empty stroke. At this time, clutch pedal free stroke is 8-12mm

Adjustment of the brake pedal free play

Loosen locknut of brake pedal push rod and adjust adjusting nut, and then measure the vertical distance from pedal free position to the position where pressing resistance increases apparently when depressing pedal. The value should be between 8mm and 12mm. After adjustment, lock the locknut.

Bus cleaning

- Don't pollute the environment when washing vehicle at washing shop.
- Be careful to use the high strength dissolve fluid.
- Don't damage paint layer.
- Do not directly inject the water into radiator grill on right (left) back of the bus to prevent the water from entering engine through the air filter.
- Don't pour water onto electrical equipment in order not to damage it.

Cleaning the air filter

Hint: Please replace filter element under such conditions: it has been washed 5 times; filter element has been damaged; filter element is clogged excessively; after changing the engine oil. When air filter indicator on combination instrument lights, clean the air filter or replace the element.

Dirty air filter would lead to deficient power and engine worn. In order to assure the life and normal operation of engine, please perform periodic maintenance on air filter. Check and maintain air filter every 2000km. Under some conditions, such as heavy dust and etc., interval time should be shortened.

The engine must be stalled during the air intake system maintaining and the engine should not be started after withdrawing the filter.

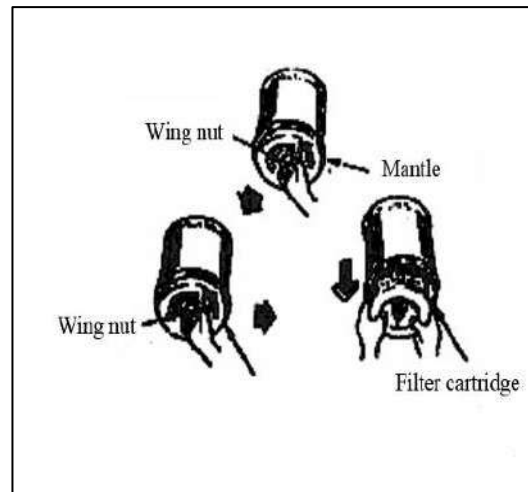

- (1) Remove butterfly nut on cover cap and take down cover cap and then take out filter element
- (2) Clean interior of the cover and the housing with a clean and dry napery. when cleaning the filter cartridge. prevent the water from entering the air filter.
- (3) Exclude dust in unloading valve.
- (4) The filter element may be cleaned by hand or by tapping the end surface with a wood bar or blowed by compressed air . Also wash with lotion. But take care not to break element.

Blow with compressed air: blow the filter element from inside to the outside with the dry compressed air of the pressure not exceeding 5bar until there has no dust blown out.

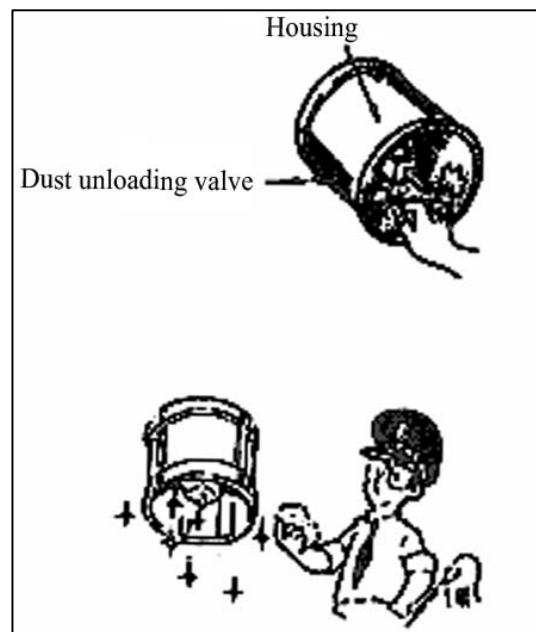

Caution: Outside surface of the filter cartridge should be cleaned with cloth instead of blown with compressed air.

Wet washing: Put filter element in lukewarm containing general cleaning agent and swing it and then clean with fresh water and dry it after dehydration.

Hint: Before wet washing, blow filter element clean.

Caution: Vapor spray gun, solution, gasoline or equivalent should not be used during the cleaning.

- Before reinstalling air filter element, check element from inside to outside with check lamp for damage;
- Check sealing ring for damage or cracks.

Caution: Do not start the engine without mounting the air filter.

Clean outside of the radiator

Keep outside of radiator clean. Compressed air current can eliminate all the dirt blocking air flow.

For vehicle equipped with intercooler, please keep air radiator fin clean. If there is hard dirt in radiator fin, blow fan side and then the other side with compressed vapor current. In order to avoid damage to air radiator fin or water radiator fin, ensure spray of air, water or vapor perpendicular to radiator surface. It should be sent to the king-long special maintenance station to make decontamination and final disposal if there has much dirt in the water radiator and the air radiator.

1. Clean water radiator fin and air radiator fin termly and eliminate dirt blocking air flow, which is important for ensuring the engine cooling.
2. For zone with many winged insect, please clean radiator fin frequently.
3. If users do not operate according to requirement, resulting in poor engine cooling and grave damage to components.
4. If don't comply with this requirement, it may cause poor engine cooling and bad damage to components.
5. Anti-freeze and antirust solution (mixture of glycol and water) should be added to cooling system perennially to avoid sediment, frost, oxidation and increase boiling point.

Note: When adding coolant, please choose the same model as much as possible in case of sediment. If coolant is degenerative, replace it entirely and immediately.

- 6 . Never use water to replace coolant for a long period.

After long running of engine, scale will come into being in cooling system. It should be eliminated in time. Methods as follows: mix 700-800g caustic soda with 150g kerosene and then inject the mixed liquid into cooling water and make engine run at middle speed for 5-10 minutes. 10-12 hours later, make engine run again for 10-15 minutes and then drain aqueous solution and clean cooling system with clean water.

Charging-up the coolant

Anti-freeze and antirust solution (mixture of glycol and water) should be added to cooling system perennially to avoid sediment, frost, oxidation and increase in boiling point.

NOTE: When adding coolant, please choose the same brand as much as possible in case of sediment. If coolant is degenerative, replace entirely.

After long operation of engine, please eliminate scale in cooling system in time. Methods as shown

below: mix 700-800g caustic soda with 150g kerosene and then inject the miscible liquids into water, at this time, make engine run at middle speed for 5-10 minutes. 10-12 hours later, make engine run again for 10-15 minutes and then drain aqueous solution and clean cooling system with fresh water. Coolant specification as shown below: the users should choose proper brand according to requirement:

Specs °C	Max. boiling point °C	Content of glycol	Pure water	Additive
-45 °C	108.00 °C	58%	32%	10%
-40 °C	107.50 °C	54%	36%	10%
-35 °C	107.00 °C	50%	40%	10%
-30 °C	106.50 °C	46%	44%	10%
-25 °C	106.00 °C	42%	48%	10%
-20 °C	105.50 °C	38%	52%	10%
-15 °C	105.00 °C	34%	56%	10%
-10 °C	104.50 °C	30%	60%	10%

Fuel recommendation

1. Diesel oil (only apply to diesel vehicle) : only diesel oil of which cetane value is not less than 45 according to GB252 standard can be used. Sulfur content should not be more than 0.2%.
2. No. 0 light diesel oil: Suitable for the zone where venture rate is 10% and minimum temperature is higher than 4°C.
3. No.-10 light diesel oil: Suitable for the zone where venture rate is 10 percent and minimum temperature is more than -5°C.
4. No.-20 light diesel oil: Suitable for the zone where venture rate is 10 percent and minimum temperature is more than -14°C.
5. No.-35 light diesel oil: Suitable for the zone where venture rate is 10 percent and minimum temperature is more than -29°C.
6. Natural gas (only apply to Natural Gas Vehicle):use natural gas of which methane value is low to 65.

Oil quality and specification recommendation

Engine oil

- Prefer using the engine oil whose quality is equivalent to or higher than level CF-4 or CH-4 of American Petroleum Institute API, or refer to the engine specification.
- Part of engine oil used for lubricating the piston will be burnt out (consumed) during the engine running. Engine oil must be replaced in certain period because of high temperature effect and the oil combustion product interfusing in the oil, especially the chemical additive in the oil will cause "abrasion" of the oil. This kind of abrasion depends on working condition of engine, quality of fuel and engine oil; therefore there has different oil changing interval. (Recommended oil changing interval is 12000km.)

Engine oil viscosity

- Since oil viscosity fluctuated with temperature, so the ambient temperature of engine working area is very important to select viscosity grade (as shown in the figure). When temperature exceed lower limit, it may decrease cold start capacity of the engine but will not make any damage to the engine.
- Higher sticky engine oil may cause the engine difficult to start, so the ambient temperature of the engine starting is the main reference for selecting viscosity of the winter engine oil. Selecting multifunctional engine oil may avoid oil changing caused by temperature fluctuation.

HINT: Never add any additive to above engine oil and different kinds of oil should be avoided using at the same time (oil mixture must be the same grade oil and it is recommended to replace in time).

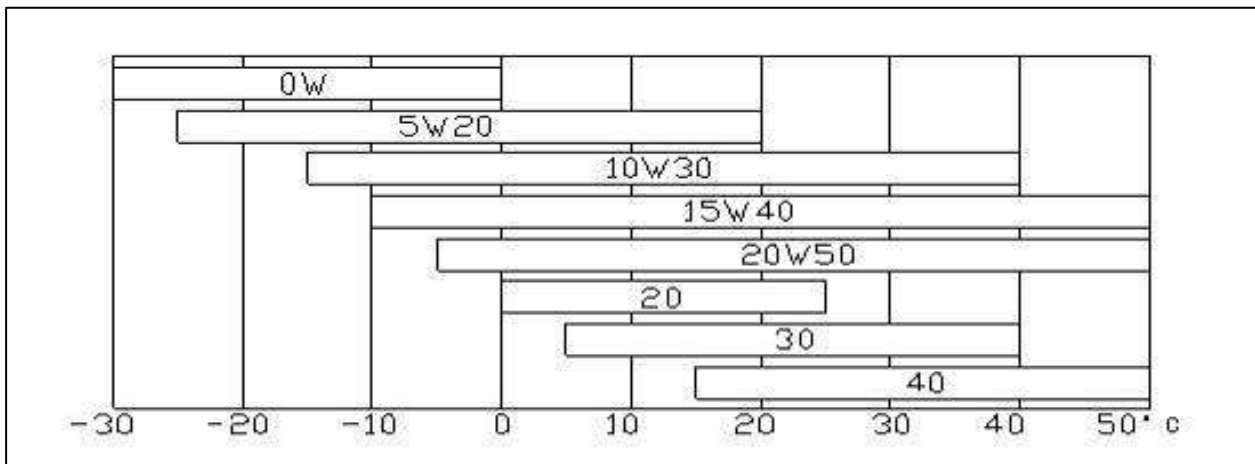

Gear oil:

Recommended gear oil is Ecofluid A+

Apply gear oil in accord with SAE90 API GL-5 grade. Recommended gear oil viscosity grade is related to ambient temperature, as shown in figure.

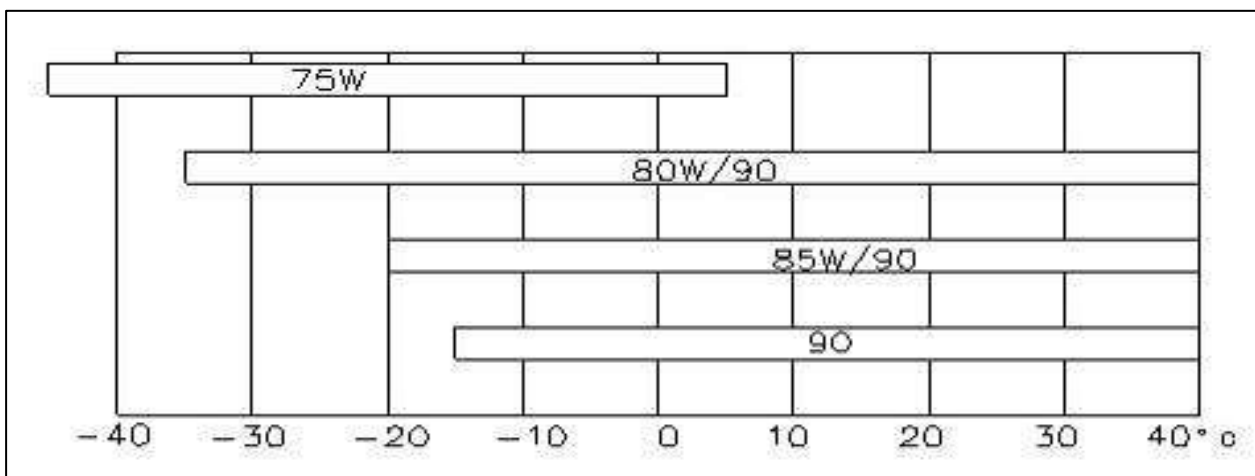

Power steering hydraulic oil:

Fulfill standard: General Allison C-3. When ambient temperature is low than 10°C, please apply DEXRON-II hydraulic fluid to steering gear; when ambient temperature is higher than 10°C, please apply C-3/10W hydraulic fluid. C-3/10W grade oil can be used in most area .all-year generally. C-3/30 grade oil can be used in non-cold area all-year generally.

Final drive lubricant:

Meet the using condition of GL-5(SAE90) grade heavy duty hyperboloid gear oil defined by API and the ambient temperature requirement.

Clutch oil:

➤ It is compound brake fluid (Laike 901) and must fulfill the standard GB10830-98JG3, GB12981 91H2Y3. It should be paid attention not to mix brake fluid with different types, otherwise it will affect the using effect. The original brake fluid should be cleaned out before replacing the compound brake fluid.

Chassis grease:

- Grease added in each part should use 2 # lithium base lubricant (suitable for temperature within the range of -30~ +120°C).
- Vehicle with centralized lubrication should use 0# lithium base lubricant.

Water tank coolant:

➤ Long life anti-freezing and antirust fluid should be added to water tank. The coolant could be general used both in winter and summer without adding and draining water in winter and it can prevent forming scale and corroding cooling system. Freezing point of the coolant should be noticed to 5°C lower than the lowest environment temperature. Different type of coolant should not be mixed using.

➤ Replacing period of the coolant is 2 years.

For specification of the coolant please see the section "filling up coolant" in the chapter "maintenance and service ".

Breaking-in of New Vehicle

Engine of new vehicle should be sure not to operate at the maximum power output during the breaking-in period to keep best performance and superior efficiency as well as guarantee durable service life. Please drive cautiously and pay more attention to abnormal phenomenon occurred during breaking-in period. Given break-in mileage of the new vehicle is 2,500 km. keep under 100 km/h in breaking-in period.

Preparation before breaking-in of the new vehicle

1. Wash the vehicle and check connection and tight situation of each place.
2. Check coolant storage in radiator and check each place of cooling system for leakage.
3. Check oil level of engine, clutch control system, transmission, drive axle, steering gear and clutch oil storage tank. If deficient, add and then check each place for leakage.
4. Check and see if braking system works properly and leakage phenomenon exists at connections of all valves and pipelines.
5. Check and see if phenomenon of loosening or clogging exists at each place of steering system.
6. Check and see if electric equipments, lamps and the instruments work properly and check battery electrolyte level.
7. Check whether tire pressure has meet requirement.
8. Check and see if each transmission gear can engage properly.

Maintenance during breaking-in period

1. Running on smooth and good road surface.
2. Drive properly and engage the clutch smoothly. Gear shifting smoothly and impact is not allowed. Neutral gear sliding is forbidden while engine stop. Emergency brake should occur as few as possible.
3. Speed limitation during breaking-in period: first gear \leq 10km/h, second gear \leq 20km/h, third gear \leq 30km/h, fourth gear \leq 50km/h, fifth gear \leq 60km/h, overspeed gear using can not be permitted during breaking-in period .
4. Load limit: No load within 250km and never overload after 250km.
5. Often pay attention to the temperature of transmission, drive axle, wheel hub and brake drum. If overheating severely, find out causes and eliminate in time .
6. Pay more attention to keep the pressure of engine oil and the temperature of engine coolant within the normal range.

Maintenance after breaking-in period

1. Tighten cylinder head and bolts (inc suspension). Tighten torque please refer to corresponding instruction. Tighten torques please refer to corresponding instructions.
2. Check valve clearance.
3. Check lubricant level of final drive and clean ventilation plug.
4. Replace engine oil、 axle oil and oil filter element.
5. Replace hydraulic oil and oil tank filter of power steering hydraulic system.

6. Check connection of transmission control mechanism for looseness.
7. Check connections of steering gear for looseness and damage.
8. Tighten bolts and nuts of front and rear suspension (carry out when full load)
9. Check connections of chassis and driving system according to specified torques. Tighten torques please refer to corresponding instructions.
10. Check hydraulic system components of steering mechanism for fixing and tightness
11. Lubricate and maintain vehicle according to maintain items at 5,000km.
12. Check complete vehicle for oil, water and air leakage.

Daily or Refueling Maintenance Check

System	Item	Operation	Technical requirement
Engine	Air cleaner	Check	No leakage, damage, and crack.
			Clips without looseness.
	Fuel-water separator	Drain	Release the water and fouling
	Cooling fan	Inspect	Do not pull or lever the cooling fan for starting the engine.
			No crack, looseness, bend or damage.
	air inlet/ outlet piping	Maintenance check	Pipes without wear and damage, clips without looseness prevent the air leakage.
	Coolant level	Check	Do not remove the water tank cover, unless the temperature is less than 50°C, otherwise, it's dangerous for operator
			Do not add the cold coolant into the hot engine, unless the engine temperature is less than 50°C
	Engine oil level	Check / correct	Do not start engine when oil level less than “L” or more than “H”.
Vehicle parking level, check the oil after engine stops for 5 minutes			
Drive belt	Check / correct	No across crack, wear or material break off	
Crankcase breather tube	Check	Check the breather tube in cold winter, cleanup the ice blocking.	
Engine and Accessories	Check	No damage and crack	
Clutch	Clutch pedal free stroke	Check / adjust	Clutch release bearing clearance
			Free stroke: 30 ~ 40 mm
	Clutch system	Check	Check if clutch separated completely, connection stable and not skidding
	Clutch brake fluid level	Check / add	Compound brake fluid
Brake chamber stroke	Check / adjust		
Air suspension	Vehicle body	Check	Observe the vehicle body whether tilt or not, the air spring (or piping) of one side is leaky if this side is lower.
	The air springs	Check	If hear the sound of leaking obviously, we can deal with the problem after confirming the specific leaky location
Training	1. Correct operation: no neutral speed skidding; no idle speed running of engine for a long time		
	2. Correct maintenance: replace oil, oil filter element, diesel filter element, transmission, axle, angle transmission system periodically, clean and replace air filter element periodically		

Periodical maintenance and operation items and regulations

Periodical maintenance of each class: do maintenance during each interval or certain miles .

Special instruction: if assembly instruction requires different oil replace period, please follow the instruction's requirement on maintenance period and operation. If else please refer to this manual for maintenance requirement.

Maintenance operation and regulation every 2500km or 1 month

System	Item	Operation	Technical requirement
Transmission (ZF series)	Lubricant oil surface	Check	Transmission lubricant oil surface within required range, transmission each part and oil seal without apparent leakage
	Lubricant oil	First filling	The lubricant ZF-Ecofluid M 02E is compulsory for initial fillings of transmissions as well as fillings during transmission break-in (for first 7500km only)
	Transmission fix bolt	Fasten	
	Transmission air hole	Check / clean	Air hole smooth
	Transmission and Accessories	Check	No leakage, operation organization effective, no abnormal sound, wrong gear engagement.
Propeller shaft	Transmission shaft cross shaft flex sleeve	Lubricate	
	Transmission shaft bolt and nut	Check and fasten	7.7 - 9m: T=180Nm 9m above:T=250-270Nm
Rear axle (ZF series)	Oil level	Check	TE-ML 12TE, 1 time per month
Front axle (DF & FS series)	Every grease nuzzle	Filling-up	2# lithium grease
	Fastening piece	Check & adjust	
	Toe-in of front wheel	Check & adjust	Radial-ply tire: 0 ~ +2mm (for first 1500km only, than adjust for every 20000km)
Rear axle (DF & FS series)	Final drive	Filling-up	From injection hole into final drive filling Parathion-type 90 heavy-duty gear oil (GL-5) to the face. (for first 1500km, than change for every 24,000km)
	Gear oil level	Check	Axle shell oil
	Every grease nuzzle	Filling-up	2# lithium grease

System	Item	Operation	Technical requirement
Rear axle (DF & FS series)		Check & fasten	Rear axle housing and differential housing, rear axle housing rear cover half axle bolts and nuts, No loosen
	Fastening piece	Check & adjust	
	Ventilate stopper	Clean	
Front axle & Rear axle	All wheel nuts	Fasten	Screw torque 7.7 - 9m: front 450 Nm rear 450 Nm 9m above: DF: front 470 Nm, rear 490 Nm
	Tire (include spare Tire)	Check, air charge, replace	Tire pressure: 0.67 ~ 0.75MPa, clean, no crack, erosion or distortion, replace Tire if abraded too much

Maintenance operation and regulation every 5000km

System	Item	Operation	Technical requirement
Steering system	Working condition	Check	Steering wheel max free rotation at middle 10 degrees
	redirector auxiliary oil and filter element	Check	Below 10°C use DEXRON-II; above 10°C use C-3/10W
	Fix bolts of each place	Fasten	Each fastening bolts not loosening, steering arm not loosening, steering wheel swift,
	Ball head	Lubricate	Each turning ball head not loosening, no clogging, clearance normal
	ZF series		Maintenance Free
	GX85, GX 100, ZJ 100C	Change oil and filter core of oil tank	For first 5000km only, N32 which manufactured by Shanghai oil refining factory or ATF or related products which produced.
	IPS series 25,35,40,55,65	Change oil and filter core of oil tank	For first 5000km only, Environment temperature >10°C, adopt CD level 15W/40 oil; Environment temperature <10°C, adopt No.8 hydraulic drive fluid.
Transmission (ZF series mechanism transmission)	Transmission fix bolt	Fasten	
	Transmission and Accessories	Check	No leakage, operation organization effective, no abnormal sound, wrong gear engagement.
	Lubricant oil	Change	The lubricant ZF-Ecofluid M 02E is compulsory for initial fillings of transmissions as well as fillings during transmission break-in (only first 7500km)

System	Item	Operation	Technical requirement
Front axle (DF & FS series)	Brake clearance	Check & adjust	
Rear axle (DF & FS series)	Brake clearance	Check & adjust	
Air suspension	Fasteners	Check/tighten	Check and tighten the bolts, rods, height control valves, air springs, shock absorbers, anti-roll bars.
	The top covers of air springs, height control valves and the joints of the air course	Check	Listening and wiping the liquid soap. If find any place is leaky, please either tighten the joints or change the seal tape and clean the accumulated water, oil in the piping and the dirt in the joints
Air suspension	The exterior surface of air springs	Check	Find out the places which are abraded, distended, bumped or cut
	The air spring	Change	The surface of the air spring is damaged and appears the cord fabric
	The air spring	Adjust/check	If air spring interfere and knock with the components around it, please adjust it in time.
	The air spring surface	Check/clean	Clean the lubricant grease on the surface, the dirt on the piston, the abnormal things placed between the piston and air spring.
	The air spring	Check	If there is leakage in the joints of the air springs and the top cover, the air springs should be taken apart, then check whether the edges of the air springs and the top cover or the tapered sealing zone are distorted. Change it if it is distorted.
	The bumper	Check	It's damage maybe the root damage of the tapered sealing zone
Air suspension shock absorber	The height control valve	Check	If a height control valve controls two air springs and one air springs is leaky, the other air springs has not air too.
	Shock absorber	Check	The external damage, the welding damage and the sealing damage result to the leakage of the shock absorber.
	The rod	Check	Check the rubber of the rod ball head and the rivet of the sleeve pipe and the ball head. Check the clamp and the tighten bolts if the it is the adjustable rod
	The rubber liner	Check	Check the ball joints of the anti-roll bar and the rubber liner bushing of the boom

System	Item	Operation	Technical requirement
Brake System	The brake pedal free stroke	Check & adjust	10 - 15mm
	The braking condition	Check	Shoe drum clearance: 0.30mm ~ 0.50mm, in complete braking, pedal stroke not surpass 1/2 of the whole stroke, check dry tin condition
	The brake pressure	Check	Check whole vehicle brake pressure as required or not. Above 0.6MPa
	The brake nuts	Inspect	Inspect fastening of rear brake board's nut 7.7 - 9 (m): 150-180 Nm, 9m above: front; 160-205 Nm, rear: 196-245 Nm
	The pipe and joint sealing	Check	Check brake pipe and joint sealing , No leakage
Chassis	Fastening body and chassis connective bolts, nuts	Check	
	The whole vehicle body butter nozzle	Lubricate	Grease nozzle complete and effective, lubrication good
Electrical equipment	The whole vehicle light and instrument	Check	
	The battery fluid surface	Check	Add distilled water,
	The wire joint firmness, no rust	Check	No rust
	Air-con radiator filtration net	Clean	

Maintenance operation and regulation every 10000km or 3 months

Every 10000km include every 5000km maintenance operation

System	Item	Operation	Technical requirement
Engine	Oil	Replace	Check oil surface within required range
			Check engine and oil seal without apparent leakage
			Replace oil when engine water temperature is 60°C, for removing the impurity
			Oil level more than CF
	Oil filter	Replace	Before installation add 1/2—3/4 to filter
	Air filter	Check	Clean air filter element
	Air inlet/ outlet system	Check	No air leakage, no damage, each clip fastening good
	Cooling system and Intercooler	Check	No leakage, each clip without damage or loosen
			Water tank without leakage, damage, fouling
	Coolant filter	Replace	Before re-install the coolant filter, daubs the 15W-40 lubricate oil on the interface of the sealing ring.
	Fuel pump installation	Check	No leakage
Air compressor	Check	No air, oil, coolant leakage, lock nut and bolt no loosen or damage	
		No carbon deposit	
Brake system	Check	No leakage	
Propeller shaft	fastening bolt	Check and fasten	Propeller shaft flange fastening bolts not loosening
	universal joint	Check and fasten	Universal joint each bearing no loosening or damage
Front axle (DF series)	Brake bottom board	Check	No loosening
	Hub bear	Check	No loosening
	Brake plate	Check / change	Change the brake plate when plate abrasion more than limit pit.
Rear axle (DF series)	Brake bottom board	Check	No loosening
	Hub bear	Check	No loosening
	Brake plate	Check / change	Change the brake plate when plate abrasion more than limit pit.
The leaf Suspension	Leaf spring	Check	Each fastening bolt not loosening, leaf spring no broken piece, no apparent change of elasticity
Brake system	Rear braking system	Check	Check brake friction piece thickness within required range by check port, visual check brake adjust arm working condition, running and stop brake good, each brake pipeline and air line no leakage

Maintenance operation and regulation every 20000km or 5 months depend on what occurs first.

Every 20000km include every 10000km maintenance operation

System	Item	Operation	Technical requirement
Engine	Fuel filter	Replace	Replace fuel filter element accordingly
	Steering hydraulic oil	Replace	Steering auxiliary oil surface within required range
	Coolant system – anti-freezing	Check	Check the density of anti-freezing
Propeller shaft	Dust-proof cover	Check	Dust-proof cover without crack, damage, clip reliable, bracket no loosening
	Universal joint condition	Check	Universal joint without loosening, no block abnormal sound
	Propeller shaft bracket	Check	Propeller shaft bracket no loosening, screw torque 120 ~ 140Nm
	Middle bearing clearance	Check	Middle bearing clearance no more than 3mm
	Lubricate	Lubricate	Lubricate each butter nozzle with 2# lithium lubricant grease
Steering system	GX85, GX 100, ZJ 100C	Change oil and filter core of oil tank	N32 which manufactured by Shanghai oil refining factory or ATF or related products which produced.
	IPS series 25,35,40,55,65	Change oil and filter core of oil tank	Environment temperature >10°C, adopt CD level 15W/40 oil; Environment temperature <10°C, adopt No.3 hydraulic drive fluid
Front axle	Toe-in of front wheel	Check & adjust	Radial-ply tire: 0 ~ +2mm
Rear axle (DF & FS series)	Final drive	Filling-up	From injection hole into final drive filling Parathion-type 90 heavy-duty gear oil (GL-5) to the face. (for first 1500km, than change for every 24,000km)
The leaf suspension		Check and fasten, weld accordingly	Not loosening, crack, fracture, misplacement, screw U bolt, front 196 ~ 294Nm, rear 343 ~ 392Nm
The air suspension	The liner bushing of the rod assembly	Change	The liner bushing is relative sliding with the ball head
		Change	The liner bushing is knocked to bend and the tighten bolts of the adjustable rod are becoming invalid which result to the threads of the ball head and the steel pipe damaged.
	The rubber ball joints	Change	The crack on the surface of the rubber is very serious. The depth of the crack is up to 2mm and the length of it is up to 8mm

System	Item	Operation	Technical requirement
The air suspension	The rubber ball joints	Change	There are gaps on the surface of the rubber
			The surface of the rubber become adhesive, brittle and the rubber drop off seriously
			The connection of the metal and the rubber is damaged. The partial depth is up to 6mm
			The rubber ball joint rotates in the inner hole of the ball head and will
	The height control valve.	Check adjust	Check the equilibrium position of the adjustment bar of the height control valve.
	The rubber of the link rod	Change	Change it if the rubber of link rod becomes ageing, brittle, adhesive and lose its elasticity
	The connecting members of the shock absorber	Check change	Check the connecting members of the shock absorber if they are damaged please adjust or change them.
the rubber	Check change	If the rubber is crack, brittle, adhesive and loses its elasticity please adjust or change them.	
The height	Check adjust	Charge the air springs and adjust to the design height, then check the wheel base, the height of the vehicle body and the two side wheels' locations which are relative to the frame. If it is necessary please adjust the height of the air springs and the length of the rod in order to arrive to the design request	
Brake system	Brake pedal free stroke	Check	Break pedal free stroke 12 ~ 15mm
	Brake valve and pipe joint	Check and fasten	Break valve and pipe joint connection reliable and without air leakage
	ABS system	Check	ABS working properly
	Auxiliary brake, stop brake free stroke	Check	Effective, 20% dual direction stopping at slop reliable
	Retarder	Check	Retarder working properly
	Engine exhaust brake	Check	Exhaust brake working properly
Body, frame	door lock function	Check	Lock function good Sealing good
	cabin door sustain pole or air spring	Check	Cabin door lock function good, sustain pole or air spring effective
	inside and outside mirror	Check	Complete, no crack, effective, mirror clean, installation firm and reliable

System	Item	Operation	Technical requirement
Body, frame	front rear wind shield and side window glass	Check , clean	Clean, no crack, sealing good
	body with paint	Check	Body paint no crack or peeling, re-paint color the same as original
	pattern, character, company mark	Check	Pattern, character, company mark clear, complete
	Body and frame	Check	Function reliable, working properly, no distortion, crack, fracture, welding split, connective bolts and rivet fix firm and reliable
Inside establishment	Driver seat	Check	Fix firm, front rear up down lock function reliable Installation firm, backrest angle adjust lock function reliable
	Safety set	Check	Safety belt function good, connection reliable, fire extinguisher, urgency hammer complete and effective
	seat cover, carpet, curtain and armrest	Check	Clean, complete and firm
Compressor, air reservoir, safety valve	Compressor, air reservoir, safety valve	Clean, screw	Clean, connection reliable, no air leakage, safety valve normal, pressure at 8Mpa, check air reservoir, if with seeper, replace air drier filter element
Electrical equipment	Front lamp, horn, meters and signal	Check	set complete and effective
	Wiper generator	Check	Effective
	Wiper connection rod	Check, adjust	Reliable
	Whole vehicle wiring	Check, adjust	complete, reliable, insulation good
Air-conditioner	Air-con passage and read lamp control panel	Check	Air-con passage installation reliable, functional and effective
	Air vent set	Check	Installation firm , working properly
	Air-con strap tension and surface condition	Check	Tension proper, strap without crack, scuffing or distortion
	Magnetic clutch, fill lubricant	Check	Work properly, lubricant: 2# lithium grease
	Air-con pipe	Check	No leakage or interference
	Condenser, evaporator	Check	Clean, no dirt
	Coolant and fuel qty	Check	Up to requirement, fill if necessary
	Control switch	Check	Installation firm, operation normal and reliable
Heating system	Fuel, water heat pipelines	Check	No crack, oil, air or water leakage, joint not loosening, oil and water pipelines smooth
	Heating device	Check	Pipeline connection reliable, operation good

Maintenance operation and regulation every 40000km or 8 months depend on what occurs first.

Every 40000km include every 20000km maintenance operation

System	Item	Operation	Technical requirement
Engine	Drive belt, Cooling fan belt tension	Check/adjust	Check each belt without loosening or damage
	Cooling fan bearing and bolt	Check/adjust	No damage, fouling, loosening
	Belt tension pulley bearing	Check/adjust	No damage, fouling, loosening
	Cylinder cover bolt	Check/adjust	No damage, loosening
	Air dryer	Replace	Replace air dryer
Suspension	Leaf spring bushing	Check	Clearance between leaf spring bush and pin normal, no abnormal abrasion, bush not crack, lubrication normal

Maintenance operation and regulation every 80000km or 12 months depend on what occurs first.

Every 80000km include every 40000km maintenance operation

System	Item	Operation	Technical requirement
Engine	Thermostats	Replace	
	Fuel roughing filter	Replace	
	Cooling system	Release/ clean/ add	
	Radiator	Check	Radiator without leakage, damage, fouling. Hose without damage, clips without loosen or damage.
	Engine suspending	Check/fasten	Connection reliable, firm, soft mat no distortion layer or crack
	Overhead set- valves and injectors	Measure	Valve clearance within required range
Clutch	Clutch brake fluid level	Charge	Compound brake fluid
The leaf suspension	leaf spring bushing	Check	Clearance between leaf spring bushing and pin normal, no abnormal abrasion, bushing without crack, lubrication normal

Maintenance operation and regulation more than 80000km

ZF Series axle

Oil or Grease change required, depending on what occurs first.

Products name	Model	Maintenance content	Maintenance interval	Oil class	Remark
Front Axle	RL 85A RL 85E RL 55E	Filling-up grease(lubricant point)	80,000-90,000KM or 1 year	NLGI Class 2	
		check-up oil level and change oil regularly every 20000KM	90,000~120,000KM 2 years	TE-ML 02	for front axle head of lubricant only
		lubricant grease of shaft of wheel hub change	Every 2 years	TE-ML 12	
Rear Axle	AV132 A80 A131	Oil change	150.000 km / 3 years	TE-ML122RL	
Rear Axle	A-132 (New AV-132)	Oil change	150.000 km / 3 years	TE-ML 12TE	Old model
		lubricant grease of shaft of wheel hub change (include oil seal)	250,000KM or 2 years	RENOLIT LX-PEP 2Rs36/04e	ZF parts No.: 0671 190 122
Wheel bearings with individual mounts at the front and rear axles			500.000 km / 2 years		
Compact bearings (hub unit) in the wheel heads at the front and rear axles			500.000 km / 4 years		

System	Application	Oil change interval	Oil classes
Transmission	- Scheduled routes - Average speed from 20 to 60 km/h	360,000 km 3 years	ZF-Ecofluid M 02A(1) / 02B(1) / 02D / 02E / 02L These lubricant classes may generally only be used in broken-in transmissions
	- Long-distance coach journeys - Average speed as of 60 km/h	540,000 km 3 years	

Maintenance period chart																			
1、1st line is the item of break-in of new vehicle (prescript items completed after driving 2500KM or the day of registration vehicle) 2、Other items are compulsion maintenance program (the circulation is 80000KM/12 months) 3、For engine、axle、transmission please refer to producer's maintenance manual, if without special maintenance period, please refer to this manual for maintenance information. 4、“R” meaning: Replacement ; “I” meaning: Inspection & adjusting; “C” meaning: Cleaning																			
Maintenance item	Maintenance period																		
	*1000km	2.5	5	10	15	20	25	30	35	40	45	50	55	60	65	70	75	80	
	Month	1		3		5		7		8		9		10		11		12	
Engine																			
Engine oil	R	I	R	I	R	I	R	I	R	I	R	I	R	I	R	I	R	I	R
Oil filter	R	I	R	I	R	I	R	I	R	I	R	I	R	I	R	I	R	I	R
Fuel filter element	R	I	R	I	R	I	R	I	R	I	R	I	R	I	R	I	R	I	R
Air filter element	C	C	C	C	C	C	R	C	C	C	C	C	R	C	C	C	C	C	
Check& adjust belt	I	I	I	I	I	I	I	I	I	I	I	I	I	I	I	I	I	I	I
Check & adjust engine idle speed	I	I	I	I	I	I	I	I	I	I	I	I	I	I	I	I	I	I	I
Fixing every bolt and connection on engine	I	I	I	I	I	I	I	I	I	I	I	I	I	I	I	I	I	I	I
Checking seal of pipe & connector	I	I	I	I	I	I	I	I	I	I	I	I	I	I	I	I	I	I	I
Coolant	I	I	I	I	I	I	I	I	I	I	I	I	I	I	I	I	I	I	R
Fuel system	I	I	I	I	I	I	I	I	I	I	I	I	I	I	I	I	I	I	I
Oil & water separator	I	I	I	I	I	I	I	I	I	I	I	I	I	I	I	I	I	I	I
Lubricating oil in gearbox of fan angle steering gear	R		I		R		I		R		I		R		I		R		R
Air compressor, air reservoir & pipe	I&C				I&C				I&C				I&C				I&C		I&C
Radiator & expand water tank	I				I				I				I				I		I
Fuel tank & oil pipe	I				I				I				I				I		I
Fuel pump	I				I				I				I				I		I
Water & oil separator core	I				R				R				R				R		R
Handle fuel pump	C				C				C				C				C		C
Water pump	I				I				I				I				I		I
Intake & exhaust manifold, muffle, exhaust pipe	I	I	I	I	I	I	I	I	I	I	I	I	I	I	I	I	I	I	I
Turbocharger	I&C				I&C				I&C				I&C				I&C		I&C
Intercooler	I&C				I&C				I&C				I&C				I&C		I&C
Engine suspension device	I				I				I				I				I		I
Valve clearance									I										I
Thermostat									I										I

Maintenance period chart																		
1、1st line is the item of break-in of new vehicle (prescript items completed after driving 2500KM or the day of registration vehicle) 2、Other items are compulsion maintenance program (the circulation is 80000KM/12 months) 3、For engine、axle、transmission please refer to producer's maintenance manual, if without special maintenance period, please refer to this manual for maintenance information. 4、“R” meaning: Replacement ; “I” meaning: Inspection & adjusting; “C” meaning: Cleaning																		
Maintenance item	Maintenance period																	
	*1000km	2.5	5	10	15	20	25	30	35	40	45	50	55	60	65	70	75	80
	Month	1		3		5		7		8		9		10		11		12
Clutch																		
Release or meshing if not smoothly	I	I	I	I	I	I	I	I	I	I	I	I	I	I	I	I	I	I
Oil pipe system	I	I	I	I	I	I	I	I	I	I	I	I	I	I	I	I	I	I
Clutch plate abrasion	I	I	I	I	I	I	I	I	I	I	I	I	I	I	I	I	I	I
Free stroke of clutch pedal	I		I		I		I		I		I		I		I		I	
Clutch oil	I		I		I		I		I		I		I		I		I	R
Clutch cylinder & stroke	I		I		I		I		I		I		I		I		I	I
Transmission																		
Transmission if not leaking oil	I	I	I	I	I	I	I	I	I	I	I	I	I	I	I	I	I	I
Selector mechanism	I	I	I	I	I	I	I	I	I	I	I	I	I	I	I	I	I	I
Lubricant oil	R		I		I		I		R		I		I		I		I	R
Venthole	C	I	I	I	C	I	I	I	C	I	I	I	C	I	I	I	C	C
Propeller shaft																		
Drive shaft connecting parts	I	I	I	I	I	I	I	I	I	I	I	I	I	I	I	I	I	I
Add lubricating oil in drive shaft	I	I	I	I	I	I	I	I	I	I	I	I	I	I	I	I	I	I
Universal joint cross & bearing	I		I		I		I		I		I		I		I		I	I
Fixing the bolt	I		I		I		I		I		I		I		I		I	I
Middle bearing bracket & clearance	I				I				I				I					I
Brake system																		
Brake pedal free stroke adjustment	I	I	I	I	I	I	I	I	I	I	I	I	I	I	I	I	I	I
Driving brake , parking brake	I	I	I	I	I	I	I	I	I	I	I	I	I	I	I	I	I	I
Brake pipe & connector seal	I	I	I	I	I	I	I	I	I	I	I	I	I	I	I	I	I	I
Air dryer	I	I	I	I	I	I	I	I	R	I	I	I	I	I	I	I	I	R
Brake air pressure	I	I	I	I	I	I	I	I	I	I	I	I	I	I	I	I	I	I
ABS system checking	I	I	I	I	I	I	I	I	I	I	I	I	I	I	I	I	I	I
Brake board fixing	I		I		I		I		I		I		I		I		I	I
Retarder	C		C		C		C		C		C		C		C		C	C

Maintenance period chart																		
1、1st line is the item of break-in of new vehicle (prescript items completed after driving 2500KM or the day of registration vehicle) 2、Other items are compulsion maintenance program (the circulation is 80000KM/12 months) 3、For engine、axle、transmission please refer to producer's maintenance manual, if without special maintenance period, please refer to this manual for maintenance information. 4、“R” meaning: Replacement ; “I” meaning: Inspection & adjusting; “C” meaning: Cleaning																		
Maintenance item	Maintenance period																	
	*1000km	2.5	5	10	15	20	25	30	35	40	45	50	55	60	65	70	75	80
	Month	1		3		5		7		8		9		10		11		12
Brake system																		
Brake drum & wearing plate abrasion	I		I		I		I		I		I		I		I		I	
Brake shoe plate clearance	I				I				I				I					I
FR & RR brake checking	I				I				I				I					I
Engine exhaust brake	I				I				I				I					I
ABS unit checking	I								I									I
Brake valve & other valves	I								I									I
Axle & Tire																		
Tire& steel ring	I	I	I	I	I	I	I	I	I	I	I	I	I	I	I	I	I	I
Checking & fixing RR axle housing & differential housing , RR cover half shaft bolt nut	I	I	I	I	I	I	I	I	I	I	I	I	I	I	I	I	I	I
Lubricant steering main pin & brake adjusting arm & cam shaft	I		I		I		I		I		I		I		I		I	
Fixing wheel nut	I		I		I		I		I		I		I		I		I	
Tire transposition			I						I									I
Four-wheel maintenance , clean bearing	I				I				I				I					I
Checking & fixing front axle bolts ,nuts, bearings	I				I				I				I					I
Checking & fixing rear axle bolts, nuts, bearings	I				I				I				I					I
Clearance final drive vent hole	C				C				C				C					C
Rear axle gear oil	R				I				R				I					R
Front wheel alignment	I								I									I
Tires air pressure	I	I	I	I	I	I	I	I	I	I	I	I	I	I	I	I	I	I
Wheel rim, flange, spoke	I	I	I	I	I	I	I	I	I	I	I	I	I	I	I	I	I	I
Suspension system																		
Thrust pole , connecting pole installation	I		I		I		I		I		I		I		I		I	
Air bag height, seal, integrity	I	I	I	I	I	I	I	I	I	I	I	I	I	I	I	I	I	I
Suspension system fixing piece	I				I				I				I					I

Maintenance period chart																		
1、 1st line is the item of break-in of new vehicle (prescript items completed after driving 2500KM or the day of registration vehicle) 2、 Other items are compulsion maintenance program (the circulation is 80000KM/12 months) 3、 For engine、 axle、 transmission please refer to producer’s maintenance manual, if without special maintenance period, please refer to this manual for maintenance information. 4、 “R” meaning: Replacement ; “I” meaning: Inspection & adjusting; “C” meaning: Cleaning																		
Maintenance item	Maintenance period																	
	*1000km	2.5	5	10	15	20	25	30	35	40	45	50	55	60	65	70	75	80
	Month	1		3		5		7		8		9		10		11		12
Suspension system																		
Suspension system lubricate oil	I	I	I	I	I	I	I	I	I	I	I	I	I	I	I	I	I	I
Absorber working condition	I								I									I
Steel plate suspension bush	I								I									I
Left & right steel plate suspension flexibility	I								I									I
Fixing suspension U type bolt	I		I		I		I		I		I		I		I		I	I
Valves function	I								I									I
Bracket & lifting lug installation & wearing state	I								I									I
Steering system																		
Checking steering system working condition, oil leakage	I	I	I	I	I	I	I	I	I	I	I	I	I	I	I	I	I	I
Steering wheel free stroke & working condition	I	I	I	I	I	I	I	I	I	I	I	I	I	I	I	I	I	I
Checking power steering hydraulic pressure system	I		I		I		I		I		I		I		I		I	I
Steering booster oil & filter core	R		I		I		I		R		I		I		I		I	R
Fixing bolts	I		I		I		I		I		I		I		I		I	I
Lubricating steering ball	I		I		I		I		I		I		I		I		I	I
Oil pump working condition	I								I									I
Steering angle checking & adjusting	I								I									I
Checking the crack of steering framework, steering knuckle & knuckle arm, vertical arm & axle									I									I
Main pin clearance									I									I
drive steering hydraulic oil	I	I	I	I	I	I	I	I	R	I	I	I	I	I	I	I	I	I
Toe-in of front wheel	I				I				I					I				I

Maintenance period chart																		
1、1st line is the item of break-in of new vehicle (prescript items completed after driving 2500KM or the day of registration vehicle) 2、Other items are compulsion maintenance program (the circulation is 80000KM/12 months) 3、For engine、 axle、 transmission please refer to producer’s maintenance manual, if without special maintenance period, please refer to this manual for maintenance information. 4、“R” meaning: Replacement ; “I” meaning: Inspection & adjusting; “C” meaning: Cleaning																		
Maintenance item	Maintenance period																	
	*1000km	2.5	5	10	15	20	25	30	35	40	45	50	55	60	65	70	75	80
	Month	1		3		5		7		8		9		10		11		12
Electrical system																		
All lights	I		I		I		I		I		I		I		I		I	
Battery electrolyte surface , connector	I		I		I		I		I		I		I		I		I	
Wire box installation	I	I	I	I	I	I	I	I	I	I	I	I	I	I	I	I	I	I
All wires , circuitry, connectors	I		I		I		I		I		I		I		I		I	
A/C system & pre-heater system																		
Air conditioner system refrigeration working condition	I		I		I		I		I		I		I		I		I	
A/C compressor belt rate of tension	I				I				I				I					I
A/C system pressure, compressor freeze oil quantity	I				I				I				I					I
Autonomous water heat system-fuel supply system	I				I				I				I					I
Autonomous water heat system-water supply system	I				I				I				I					I
Vehicle body, framework																		
Luggage bin door air spring, stay bar	I				I				I				I					I
Engine bin door air spring, stay bar	I				I				I				I					I
Rearview mirror fixing	I				I				I				I					I
Vehicle body, framework checking	I								I									I

Engine common trouble and its elimination (suitable for diesel engine)

Diesel engine can not start

Possible causes	Remedies
1) Too low starting speed	1) Check the starting system and assure the starting speed is not lower than 110rpm.
2) Air exists in the injection system	2) Check the looseness of the joints of the feed line. Unscrew the de-aeration bolt on the fuel cleaner and oil water separator assembly, then press fuel with hand priming pump until the fuel overflows without air bubbles.
3) Fuel pipe clogged	3) Determine the location of the clog and clear it.
4) Fuel filter choked	4) Replace the screw-on filter element of the fuel filter/oil-water separator assembly.
5) Fuel supply pump does not apply fuel or applies fuel irregularly	5) Check for leakage in the fuel inlet pipe Clogging of the fuel supply pump filters and fix or replace.
6) Insufficient fuel injection, without fuel injection or low injection pressure	6) Check the injector atomization situations and replace a new one if it doesn't work.
7) Starting system problems:	7) Check the connection to be correct and reliable.
Incorrect terminals connection or bad contact;	
Insufficient battery charge;	Charge the battery.
Bad contact between the brush and communicator of the starter	Repair or replace the brush and clean the surface of the communicator with soft sand paper and blow off.
8) Insufficient compression pressure;	8) Replace the piston ring and press in the cylinder sleeve if necessary.
Piston ring worn-out	
9) The fuel cut off solenoid valve joint is loose, dirty or corroded smudginess canker	9) Check the valve clearance, valve spring, valve stem, and valve seat. Grind the valve seat if necessary. Tighten and wash or replace.
10) Mounting timing incorrect	10) Check and adjust it.

Diesel engine power deficient

Possible causes	Remedies
1) Intake blocked	1) Check the air cleaner, intake pipe, and clean or replace the air cleaner filter elements.
2) high exhaust back pressure	2) Check the valve timing, adjust it if necessary; Clean the exhaust pipe.
3) Insufficient boost pressure of turbocharged system	3) Check and eliminate the leakage in the pipe and joints.
4) Turbocharger is out of order; Compressor and turbine passages are polluted, clogged or damaged;	4) Dean or replace the compressor casing and turbine housing.
Bearing failure;	Replace it.
Carbon deposit and sludge in the back of turbine and compressor impellers.	Clean it.
5) middle cooler mangle ,leave out	5) Check and replace it.
6) Fuel line blocked or leaky	6) Check the seal of fuel line and fuel filter choking, or replace screw-on filter element.
7) Poor atomization of injector	7) Check the inject pressure, remove carbon, adjust and repair
8) Incorrect distribution phase	8) Check and adjust the distribution timing and valve lash
9) Cylinder gasket leakage	9) Tighten the cylinder head bolts according to the stated torque and order, or replace the cylinder gasket.
10) Bad valve sealing	10) Grind or replace it.
11) Overheat engine or too high coolant temperature	11) Check and repair the radiator, thermostat, and adjust fan belt tension.
12) Piston ring worn-out or broken	12) replace it
13) Sensor doesn't work	13) Check and replace it.

Abnormal noise during engine operation

Possible causes	Remedies
1) Connecting rod bearing bushing and main bearing bushing are worn-out and clash voice appears in the crankcase.	1) Dismantle and check the bushing and, if necessary, replace it and keep the reasonable clearance as required.
2) The Damper is damaged and invalid.	2) Change components to keep regulated axial clearance
3) The shock absorber is damaged and ineffective	3) Check and see if the joint bolts are in good conditions, and change new ones if necessary.
4) The valve knocks on the piston	4) Check and adjust the valve timing.
5) The driving gear is abraded and get too large gap. There is knocking sound at the timing gear box cover.	5) Check the gear side clearance and change the gear or not according to the abrasion situations.
6) Too big clearance between piston and cylinder and there is knocking sound at the cylinder wall.	6) Change the piston and use the repairing cylinder liner. Keep the proper clearance between piston and cylinder.
7) Puff vibration of supercharger	7) Remove the carbon and waste in the compressor channel and the exhaust channel.
8) The bearing of supercharger is damaged and the rotor knocks on the shell	8) Change the supercharger assembly
9) The valve clearance is too large and there is big noise at the cylinder head.	9) Adjust the valve clearance.

Exhaust with black smoke

Possible causes	Remedies
1) Intake clogged	1) Check and clean the air cleaner and intake passage.
2) Poor fuel quality	2) Use prescribed fuel.
3) Incorrect distribution timing	3) Adjust the distribution timing according to the instruction.
4) Bad atomization of injector	4) Check and repair or replace
5) The injector spray too much fuel	5) Check and adjust it according to the instruction.
6) Check and repair or replace	6) Check and repair leak in the pipe line and joints.
7) Faulty turbocharger	7) Check and replace the assembly.
8) middle cooler damaged and leaked	8) Repair or replace it

Exhaust with white and blue smoke

Possible causes	Remedies
1) Poor quality fuel and too much water in fuel	1) Replace the fuel.
2) Too low coolant temperature	2) Check the working temperature of the thermostat, replace it if necessary.
3) Incorrect distribution	3) Check and adjust it.
4) Too low Pressure	4) Check the working temperature of the thermostat, replace it if necessary.
5) Incorrect installing orientation of piston rings	5) Check and reinstall correctly.
6) Running at low load for long time	6) Operate at proper speed and load
7) Seal ring of turbocharger worn-out	7) Check and replace it.
8) thrust bearing of turbocharger worn-out	8) Check and replace it.
9) Oil return pipe of turbocharger	9) Clean or repair it.

Too low oil pressure

Possible causes	Remedies
1) Diluted or incorrectly selected	1) Select the proper oil.
2) Inner and outer rotors of oil pump worn-out or too large	2) Replace the oil pump.
3) Oil filter choked	3) Replace the whirling type filter element.
4) Failure of oil filter pressure control	4) Repair it.
5) Gear of oil pump damage	5) Replace it.
6) Inlet oil tube of fuel pump crack	6) Repair or replace it.
7) Fixing bolt of oil pump inlet oil tube loose	7) Tighten the bolt to the required torque.
8) Too large bearing bushings clearance.	8) Check and replace it.

Too high oil pressure

Possible causes	Remedies
1) Too low ambient temperature and too high oil viscosity	1) Use the required grade engine oil. Operate at low speed after starting, and then check it when the oil temperature is normal.
2) Over-flow valve clogged	2) Check and clean it

Too high oil temperature and oil consumption

Possible causes	Remedies
1) Leakage in the exterior oil line	1) Check and repair it.
2) Too high diesel engine load	2) Decrease the load.
3) Use improper oil	3) Use the oil as required.
4) Piston ring stuck or seriously worn	4) Check and repair, if necessary, replace it.
5) Too much worn out of Cylinder bore	5) Bore the cylinder and use the oversized piston rings or press in a repair –used cylinder sleeve.
6) Valve guide seriously worn out and failed seal of valve stem	6) Check and replace.

Chassis constant fault and elimination

Clutch

Fault symptom	Possible cause	Eliminating method
Abnormal sound of the clutch	1.The noise occurs when the clutch disengages 1) Flywheel support bearing stuck 2) Release bearing stuck 2. The noise occurs when the clutch engages 1) Clutch driven disk worn 2) Clutch torsion damping spring broken 3) Transmission bearing or gear broken	1) Replace the bearing 2) Replace the bearing 1) Replace the clutch driven disc 2) Replace the clutch driven disc 3) Replace the bearing or the gear
Clutch does not disengage smoothly or can not disengage	1. When operational travel of the clutch pedal is correct 1) Uneven or deformity of the clutch pressure plate or the flywheel and the driven disc 2) Abrasion or clogging of the clutch plate spline 3) Clogging of the flywheel supporting bearing 4) Pressure spring distorted 5) Impurity in the clutch plate, the pressure plate and the flywheel 6) Distortion or breakdown of the diaphragm spring 2. The clutch pedal is in normal operation but the pedal travel is too large 1) Too large of the clutch pedal pusher stroke 2) Abrasion of the pedal bushing, the interlocking pin and the pin hole 3) Too large of the clutch booster pusher stroke 3. Too small or no acting force when operating clutch pedal 1) There has air in the liquid pipeline Clutch master cylinder or booster operates abnormally	1) Correct or replace faulted parts. 2) Repair or replace the clutch plate and lubricate the moving region by anti-high temperature grease 3) Replace the bearing 4) Replace the pressure spring 5) Remove and wash. 6) Check the distortion or the breakdown and change the faulted parts 1) Adjust the travel to the given range 2) Make replacement 3) Adjust the travel to the given range 1) Exhausting 2) Disassemble and repair.

Fault symptom	Possible cause	Eliminating method
	4. No braking fluid in the clutch oil tank 1) Leakage 2) There has leakage during the hydraulic cylinder operation	1) Check and repair leakage or replace faulted components. 2) Disassemble and repair.
Slipping of clutch	1. Abrasion of the friction surface of the clutch plate, the flywheel and the pressure plate; improper connection or clogging between these parts 2. There has lubricant on the friction surface of the clutch plate, the flywheel and the pressure plate 3. Compression spring fatigued or broken 4. Improper usage of the compression spring 5. Clutch cap bolt loose 6. There has no free travel of the clutch pedal 7. The diaphragm spring appears abrasion, breakdown or fatigue situation 8. Improper adjustment of the push rod on the clutch master cylinder that pushing piston 9. Improper adjustment of the push rod that pushing the clutch cylinder 10. Improper adjustment of push rod on the clutch booster that pushing the clutch 11. Clutch master cylinder oil return port is blocked 12. Abrasion of the clutch plate	1. Correct or replace the parts 2. Clean or replace the parts 3. Replace the pressure spring 4. Replace and use the correct spring 5. Tighten bolts to specified torque 6. Adjust free play of pedal. 7. Check the clutch cover assembly and replace the faulted parts 8. Adjust length of the push rod as required 9. Adjust length of the push rod as required 10. Adjust length of the push rod as required 11. Disassemble and clean 12. Replace the clutch plate
There has vibration during the clutch engaged	1. Looseness of the rivet on surface of the clutch driven disc 2. Pressure spring broken or fatigued 3. Distortion, improper engagement and too large runout clearance for clutch driven plate, flywheel and pressure plate 4. Performance declination of the clutch driven disc surface	1. Correct or replace the clutch plate 2. Replace the pressure spring 3. Repair or replace the faulted parts 4. Replace the clutch plate

Fault symptom	Possible cause	Eliminating method
There has vibration during the clutch engaged	<ol style="list-style-type: none"> 5. Driven plate damping spring broken 6. Uneven height of the clutch lever 7. Performance declination or breakdown of the diaphragm spring 	<ol style="list-style-type: none"> 5. Replace the clutch plate 6. Adjust the height of each release lever 7. Check the clutch cover assembly and replace the faulted parts
Too large force of the clutch pedal force	<ol style="list-style-type: none"> 1. There has fault on the clutch booster 2. Release bearing bushing stuck or lubricated deficiently 3. The release bearing flange stuck 4. There has deficient lubrication of the release lever bushing 	<ol style="list-style-type: none"> 1. Disassemble, repair or clean. 2. Replace the bushing and make lubrication 3. Correct or replace the bearing flange 4. Make lubrication

Propeller shaft

Fault symptom	Possible cause	Eliminating method
Propeller shaft jogging (vehicle vibrates during driving)	<ol style="list-style-type: none"> 1. Propeller shaft sliding yoke assembled incorrectly 2. The propeller shaft is distortion or bending 3. The universal-joint journal or the needle bearing has been worn out or damaged 4. The propeller shaft loose 5. The propeller shaft is imbalance 6. The intermediate supporting bearing is worn out or damaged 7. Bracket of the intermediate supporting bearing is loose or the rubber damp piece material is aging 	<ol style="list-style-type: none"> 1. Remove and let the sliding yoke and the fixing yoke on the same plane 2. Adjust or replace the propeller shaft 3. Replace the bearing 4. Tighten propeller shaft to specified torque 5. Adjust or replace the propeller shaft 6. Replace the intermediate supporting bearing 7. Make adjustment or replacement
Abnormal sound from the propeller shaft (during the starting and the running)	<ol style="list-style-type: none"> 1. Abrasion or damage of the universal joint 2. Abrasion or damage of the sliding yoke 3. Looseness of the propeller shaft 4. Inadequate lubrication to the needle bearing, the sliding yoke and the intermediate bearing 	<ol style="list-style-type: none"> 1. Replace the universal joint 2. Replace the sliding yoke 3. Tighten it to specified torque 4. Make the lubrication

Transmission

Fault symptom	Possible cause	Eliminating method
<p>Difficult gear shift (Difficult gear engagement)</p>	<p>1. Control mechanism 1) Improper height of the control hinge 2) There has clearance between the control hinge connection 3) The control hinge bend 2. Transmission 1) Abrasion or damage of the bearing 2) Synchronizer operates abnormally 3) The shaft or the gear is wore or damaged 4) Abnormal slip of the gear shifter shaft 3. Others 1) Clutch can not disengage normally 2) The lubrication viscosity is too high</p>	<p>1) Adjust the control hinge 2) Correct or replace the parts 3) Correct or replace the control hinge 1) Replace the bearing 2) Correct or replace the parts 3) Correct or replace the parts 4) Correct 1) See " Clutch does not disengage smoothly or can not disengage " 2) Use the lubrication of given grade</p>
<p>The transmission gear is off the engaging position</p>	<p>Transmission 1) Shift fork distorted or worn 2) Abrasion of lthe lockup ball or the ball on the gear shifter shaft 3) Breakdown or fatigue of the lock spring 4) Excessive clearance of the gear engagement 5) Excessive clearance along the gearing axial direction 6) Abrasion of the sliding bearing slipper or its end surface 7) Abrasion of the main bearing Control mechanism 1) The control mechanism is out of work 2) Movement of the shifter lever causes vibration of the vehicle</p>	<p>1) Check the gear-shifter fork and make adjustment or replacement in case of bending 2) Disassemble and replace the worn-out parts 3) Replace the spring 4) Adjust the gear clearance or replace the gear 5) Measure the axial clearance and replace the thrust washer if necessary 6) Replace the bushing 7) Replace the main bearing 1) Check and correct the control hinge 2) Check damage of the engine rubber suspension and replace the faulted parts</p>

Rear axle

Fault symptom	Possible cause	Eliminating method
<p>Abnormal sound from the rear axle (abnormal sound)</p>	<p>When the vehicle is starting</p> <ol style="list-style-type: none"> 1) Excessive clearance between the differential gear 2) Excessive clearance between the driving and the driven gear 3) Looseness of the connecting flange and the propeller shaft 4) Too small pretightening force of the drive gear bearing 5) Looseness of the fixing bolt and nut of the driving gear <p>When the vehicle turning</p> <ol style="list-style-type: none"> 1) There has abrasion or damage to the axle shaft gear, driving gear, spider, thrust shim and the axle shaft bearing and etc 2) Too low oil level 	<ol style="list-style-type: none"> 1) Adjust the clearance 2) Adjust the clearance 3) Tighten it to specified torque 4) Adjust the pretightening force 5) Tighten it to specified torque <ol style="list-style-type: none"> 1) Adjust or replace the faulted parts 2) Fill up the lubrication
<p>Abnormal sound of the rear axle (improper sound)</p>	<p>When the vehicle is running:</p> <ol style="list-style-type: none"> 1) Excessive clearance between the driving and the driven gear 2) Abrasion or damage of the bearing 3) Abrasion or damage of the gear 4) Too low oil level <p>When running with inertance</p> <ol style="list-style-type: none"> 1) Too small clearance between the driving and the driven gear 2) Abrasion or damage of the bearing 3) Incorrect gear engaging position 4) Too low oil level 	<ol style="list-style-type: none"> 1) Adjust the clearance 2) Replace the bearing 3) Make adjustment or replacement 4) Fill up the lubrication <ol style="list-style-type: none"> 1) Adjust the clearance 2) Replace the bearing 3) Adjust or replace the faulted parts 4) Fill up the lubrication
<p>Leakage of the rear axle lubrication</p>	<ol style="list-style-type: none"> 1. Abrasion, looseness or damage of the oil seal 2. Looseness of the differential lock bolt or damage of the gasket 3. Damage of the differential carrier mating surface <p>Looseness of the oil draining plug or damage of the gasket</p>	<ol style="list-style-type: none"> 1. Replace the oil seal 2. Tighten to specified torque and replace gasket 3. Make trimming and replace the differential housing if necessary 4. Replace the gasket and tighten screw plug to specified torque

Fault symptom	Possible cause	Eliminating method
Leakage of the rear axle lubrication	4. Blocking or damage of the ventilation plug 5. Axle housing cracks 6. Damage or distortion of the coupling flange sealing surface 7. Malfunction of bearing leads to radial run out of coupling flange 8. Axle housing distortion caused by overloading	5. Clean or replace the ventilation plug 6. Repair or replace the axle housing 7. Adjust or replace the coupling flange 8. Replace the bearing 9. Adjust or replace the axle housing
Hub bearing jamming	1. Excessive pre-tightening force of the hub bearing 2. Inadequate lubrication of the bearing or incorrect usage of the grease 3. The bearing is defiled by the dust 4. Water entering bearing due to malfunction of sealing ring	1. Adjust the pre-tightening force 2. Intensify the lubrication or replace the grease 3. Clean and intensify the lubrication 4. Replace the sealing ring

Front axle and steering system

Fault symptom	Possible cause	Eliminating method
Steering wheel shimmy	1. The steering system 1) Steering gear housing bolt or steering column supporting loose 2) Looseness of the steering connection point 3) Excessive clearance of the steering gear housing 2. The front axle 1) Unbalance or abrasion of the rim, the spoke and the wheel 2) Abrasion of the front wheel bearing 3) Excessive abrasion of the king pin or the bushing 4) Deformation of the knuckle 5) Improper wheel alignment	1) Tighten to specified torque 2) Adjust the junction 3) Adjust the clearance 1) Balance all the components and replace faulted components. 2) Replace the bearing 3) Adjust or replace the faulted parts 4) Replace the knuckle 5) Check and adjust the wheel alignment

Fault symptom	Possible cause	Eliminating method
	6) Fatigue of the front leaf spring, looseness of the "U" -bolt or damage of the central bolt	6) Replace the faulted parts
Failure of steering wheel return to center	<ol style="list-style-type: none"> 1. The steering system <ol style="list-style-type: none"> 1) Difficulty in the gear engagement 2) Malfunction of power steering system 3) Improper contact with the power piston 4) Fatigue of the return spring 5) Malfunction of slide valve 2. The front axle <ol style="list-style-type: none"> 1) Excessive caster angle of the king pin 	<ol style="list-style-type: none"> 1) Adjust the gear engagement 2) Overhaul and eliminate trouble 3) Adjust or replace the power piston 4) Replace the spring 5) Check diameter of the slide valve and the housing and replace them if necessary 1) Check and adjust the front wheel alignment
Disalignment of the steering wheel	<ol style="list-style-type: none"> 1. The alignment of front wheel incorrect 2. There has fatigue and damage in the front plate spring 3. Bending of the front axle 4. Unsmooth of the braking 5. Looseness of the front hub bearing nut 6. Inequality of the tire pressure 7. Tires with different dimension applied 	<ol style="list-style-type: none"> 1. Check and adjust the front wheel alignment 2. Replace the faulted spring 3. Adjust or replace the front axle 4. Please refer to the chapter "braking" 5. Tighten to specified torque 6. Inflate to the given pressure 7. Replace the tire by the correct type
Misproportion or untimely tire wear	<ol style="list-style-type: none"> 1. The front axle <ol style="list-style-type: none"> 1) Incorrectness of the wheel alignment 2) Abrasion or wreckage of the hub bearing and looseness of the bearing nut 3) Over looseness or tightness of the ball stud, the king pin and the bushing 2. Tire <ol style="list-style-type: none"> 1) Tire pressure incorrect 2) Disalignment between the tire and the wheel 	<ol style="list-style-type: none"> 1) Check and adjust the front wheel alignment 2) Replace the bearing or tighten nut to specified torque. 3) Make an adjustment and replace the faulted parts as needed 1) Supply to the given air pressure 2) Replace the tire or the wheel

Fault symptom	Possible cause	Eliminating method
Misproportion or untimely tire wear	3. Others 1) Breakdown caused by the abrupt starting or the emergent braking 2) Overloading	1) Correct the driving pattern 2) Make the loading according to the specified capacity
Heavy operation of the steering wheel (the steering system breakdown)	1. Too low oil level 2. Lubricant deterioration or impurity in it 3. Abrasion of the steering junction 4. Fault of the power steering system 5. Excessive lubricant resistance caused by the pipeline sunken 6. Too low oil pressure caused by the ineffective hydraulic pump 7. There has air in the hydraulic pipeline 8. Malfunction of rotary valve 9. Abrasion or damage of the power cylinder and damage of the piston O -ring 10. Too much leakage of the oil inside the steering gear housing	1. Add the lubricant to the given level 2. Replace the lubricant 3. Replace the ball stud 4. Overhaul and eliminate trouble. 5. Measure the backpressure and repair or replace the pipeline in case of the set value exceeded 6. Measure the oil pressure and the flow volume; disassemble and repair the hydraulic pump if the set value belowed 7. Bleed air and add oil. 8. Disassemble and repair rotary valve. 9. Disassemble and repair. 10. Disassmeble and repair steering housing.
Heavy operation of the steering wheel (breakdown of the front axle)	1. Improper adjustment of the wheel alignment (excessive caster angle) 2. Too little clearance between the king pin and bushing 3. Inverse installation of the thrust bearing 4. Inadequate lubrication of the front axle parts 5. Over tight or loose connection of the bull 6. Too low tire pressure 7. Excessive abrasion of the tire	1. Check and adjust the wheel alignment 2. Check and adjust the clearance 3. Adjust the installation 4. Add the grease to the front axle 5. Check and lubricate the bulb stud 6. Inflate to the rated pressure 7. Replace the tire

There has oil spillage in the steering oil tank	<ol style="list-style-type: none"> 1. Clogging of the strainer or the filter element 2. There has air in the pipeline 	<ol style="list-style-type: none"> 1. Clean the filter strainer or replace the filter element 2. Add the oil and make the exhaustion
---	---	--

Braking system

Fault symptom	Possible cause	Eliminating method
Unsmooth of the wheel	<ol style="list-style-type: none"> 1. There has compressed air inside the braking chamber 2. Improper lubrication of the camshaft or improper return of the adjusting arm 3. Brake shoe or chamber return spring fatigued or broken 4. The spring braking takes effect 5. Clogging of the exhaust port in the quick release valve 6. Brake valve primary or secondary piston return failure 	<ol style="list-style-type: none"> 1. Check and adjust the exhaust valve of the quick releasing valve 2. Adjust the faulted parts 3. Replace the faulted parts 4. Eliminate causes of the spring braking unreleased 5. Disassemble and clean the faulted parts 6. Disassemble and clean the braking valve and replace the faulted parts as needed
There has abnormal sound when troddening the brake pedal	<ol style="list-style-type: none"> 1. The clincher or the bolt is projected because of abrasion of the braking friction lining 2. Surface hardening of the friction lining 3. Deterioration of the friction lining 4. Improperly contact between the brake shoe and the friction lining 5. Uneven abrasion of the brake drum internal surface or weak installation 6. Looseness of the brake shoe supporting 7. Abrasion of the hub bearing 8. Deformation of the brake drum 	<ol style="list-style-type: none"> 1. Replace the friction lining 2. Replace the friction lining 3. Replace the friction lining 4. Rivet the rivet or tighten bolt 5. Adjust or tighten the brake drum 6. Adjust the clearance between the brake shoes and tighten the supporting pin locknut 7. Replace the hub bearing 8. Adjust or replace the brake drum

Fault symptom	Possible cause	Eliminating method
Unsteady braking	<ol style="list-style-type: none"> 1. Tire pressure uneven or tire dimension different 2. Improper installation of the brake shoe or damage of the return spring 3. Improper engagement of the braking friction lining 4. Improper adjustment of the left and right brake 5. Deterioration of the braking friction lining 6. Oil on the braking friction lining 7. Damage of the brake backing plate 8. Looseness of the leaf spring U-bolt 	<ol style="list-style-type: none"> 1. Operate as required 2. Tighten the locknut of the brake shoe supporting pin and replace the return spring 3. Adjust the friction lining 4. Adjust the brake 5. Replace the friction lining 6. Clean with the gasoline to eliminate the effect of the leakage at the hub oil seal, oil cylinder cover and the rubber cap 7. Replace it 8. Tighten the U-bolt
The braking can't be applied under all conditions	<p>When compressed air pressure is normal:</p> <ol style="list-style-type: none"> 1. Too short of the brake valve travel 2. The camshaft doesn't rotate (the bushing is lack of lubricant) 3. Improper adjustment of the braking chamber pusher stroke 4. Improper sliding contact of the relay valve 5. Overheat or deterioration of the braking friction lining 6. Improper engagement of the braking friction lining 7. There has lubricant on the friction lining or the brake drum 8. Water entering brake drum 	<ol style="list-style-type: none"> 1. Check ,and replace the braking valve if necessary 2. Check working condition of the camshaft and replace it as needed 3. Adjust the travel 4. Disassemble and repair 5. Replace the friction lining 6. Adjust engagement position of the friction lining 7. Clean the oil trace with proper cleanser or replace the friction lining 8. Drying out the water by pressing the pedal gently during the running

Fault symptom	Possible cause	Eliminating method
	When compressed air pressure is abnormal: 1. There has air leakage inside the air pipeline 2. The air compressor doesn't work 3. The pressure regulator is improper adjusted or failed because of the impurity entering Air leakage in the brake valve	1. Repair the leakage point 2. Disassemble and repair air compressor 3. Adjust or wash 4. Disassemble and repair the brake valve

Common trouble and troubleshooting of electrical equipment and starting system

Fault symptom	Possible cause	Eliminating method
There has abnormal sound during the generator rotates	1. The belt is of over loose or excessive abrasion with the shaking during the running 2. Bearing failure or oversize clearance 3. Too much bearing clearance	Adjust the belt and replace the bearing
The charging indicator light doesn't go off during the running and the vehicle is difficult to start	1. The battery is lack of power 2. The generator is damaged 3. Charging indicator lamp loop short 4. The belt is slipping	1. Charge the battery 2. Replace the generator 3. Check the circuit 4. Adjust the belt
The battery is lack of power excessively and incapable of charging at low speed	1. The battery is damaged 2. The generator is damaged 3. The belt is slipping	1. Replace the battery 2. Replace the generator 3. Adjust the belt

Fault symptom	Possible cause	Eliminating method
Difficult in starting	<ol style="list-style-type: none"> 1. The battery has no power, or is lack of power or terminal loose 2. Poor contact of the starter switch, short circuit of the connector lug or bad of the solenoid 3. Starter pinion is clogged in the flywheel ring gear. Furthermore, engine bearing is burnt ,water on external of the combustion chamber and the consumption frozen may also caused the breakdown 	<ol style="list-style-type: none"> 1. Charge and clean the joint and screw it 2. Repair or replace it 3. Repair or replace it <p>Found out the reason and eliminate it</p>
Starting gear of the starter can not engage with the flywheel teeth	<ol style="list-style-type: none"> 1. Poor contact of the ignition switch or socket loose 2. Unsteady connection of the relay device or the solenoid switch 3. Turnoff of the starter solenoid switch 4. Damage of the starting gear or the gear ring of starter 5. Malfunction of engage switch 6. Starter armature shaft bent 	<ol style="list-style-type: none"> 1. Clean and tighten 2. tighten it 3. Replace it 4. Repair the teeth or replace it 5. Found out the reason and eliminate it 6. Replace it
Starting gear of the starter can not disengage completely	<ol style="list-style-type: none"> 1. Starter starting gear sleeve too tight or stuck 2. Too little clearance between the starting gear and the flywheel ring gear or the starter gear damage 3. Magnetic coil dirty 4. Clogging of the transmission fork shaft 5. Locking of the engage switch 	<ol style="list-style-type: none"> 1. Replace the shaft sleeve or clean and amend it 2. Adjust the clearance or replace the starting gear 3. Clean it 4. Clean and adjust it 5. Replace it

Common trouble and troubleshooting of air conditioner system

The remedy and trouble analysis under abnormal pressure

No.	Pressure	Description	Analysis	Remedy
1	The high and low pressure is lower than normal.	There is bubble in the inspection glass ; the cold air in the bus insufficient ; high pressure pipe a little bit warm and the low pressure pipe a little bit cold, the temperature difference is not too much;	The refrigerant filling is not enough and the system is leaking	Check the system for the leakage and find out the leaking point And make the maintenance Fill in refrigerant
	The high and low pressure are higher Than normal		The refrigerant is too much	Drain some part of the refrigerant or refrigerant oil
2	The high and low pressure are much lower than normal .	No liquid flow seen from the inspection glass; Almost no refrigeration Almost no temperature difference between high and low pressure pipe	Air conditioner system has serious leakage	Check the system and find out the leakage and fill the enough refrigerant
3	The low pressure is nearly to zero or even the negative value; The high pressure is lower than the normal value	No refrigerate in the system The front or the rear part of the expansion valve has fog	expansion valve blocked; expansion valve temperature sensor damaged or packing error	Changed the expanding valve Change the expanding valve temperature sensor Make good package for the expanding valve
	The high pressure and the low pressure are abnormal; The pressures are higher than the normal values	The temperature of the sucking pipe is lower than the normal value and the frosting appeared	expansion valve opened too much	Change the expanding valve Readjust the expanding valve
	The high pressure is higher than the normal value and the low pressure is lower than normal	The surface for the air suction pipe of the compressor has frost or condensate	Expanding valve damaged	Change the expanding valve

No.	Pressure	Description	Analysis	Remedy
4	The high and low pressure are much higher than the normal value and the needle of the gauge swing obviously	The cooling capability is insufficient and the system has air and the bubbles seen in the inspection glass	Air mixed in the refrigerant The vacuum is not good for the first time filling refrigerant or after the maintenance	Discharge the refrigerant in the system and change the desiccators and also make the vacuum repeatedly for filling the refrigerant
5	The high pressure is higher than the normal value and the low pressure is nearly to zero or negative value and the gauge swing seriously	The air sent to the bus sometime cold and sometimes warm and the inspection glass looks yellow	Too much water in the system desiccators reaching the saturation the frosting water blocked the expanding valve	Change the desiccators and make the vacuum repeatedly and then re-fill the refrigerant
6	The low pressure is much higher than the normal value and the high pressure is a little bit higher than the normal value	Cold is in sufficient	The condenser blower doesn't work normally or there is blockage in the condenser radiator	Check the electric circuit diagram or cleaning the condenser
7	The high and low pressure are higher than the normal values	The cold air is insufficient	Compressor interior failure	Repair or change the compressor
8	The high and low pressure are lower than the normal value	Evaporator wind flow is insufficient	Evaporator blower not running or low in efficiently or the radiator of the evaporator blocked	Check the electric circuit diagram or clean the evaporator radiator

Electric system trouble and remedy

Fault symptom	Possible cause	Eliminating method
the power lamp on the control panel not light	<ol style="list-style-type: none"> 1. + no power supply; 2. D+ not connected well; 3. harness not tight; 4. control unit failure; 	<ol style="list-style-type: none"> 1. generator D+ no output, exchange the generator and repair 2. reconnect the cable D+; 3. reconnect the harness; 4. change the control panel or repair;
malfunction light on the control panel light up	<ol style="list-style-type: none"> 1. system pressure error; 2. pressure switch defective; 3. pressure switch harness not connected well; 4. harness connection not well; 5. control panel failure; 	<ol style="list-style-type: none"> 1. to connect the manifold gauge and eliminate the malfunction; 2. change the pressure switch and repair; 3. reconnect the pressure switch; 4. harness connection; 5. change the control panel or repair;
refrigerant lamp is not lighted up	<ol style="list-style-type: none"> 1. defrost sensor failure or connection problem; 2. temperature control sensor failure or connection problem; 3. temperature control sensor installation position not good ; 4. temperature control switch defective; 5. harness connection not reliable; 6. Control panel defective 	<ol style="list-style-type: none"> 1. change the defrost sensor or connect the cable again; 2. change the temperature control or connect the harness again; 3. re-install the temperature control into the correct position; 4. change the temperature control switch or repair; 5. harness connection again; 6. change the control panel or repair;
condenser fan not working	<ol style="list-style-type: none"> 1. malfunction lamp light up; 2. sensor failure; 3. relay failure; 4. fuse burnt; 5. battery not charge or connection loose; 6. harness connection not tight; 7. air blower connection loose; 8. air blower failure; 9. control panel failure; 	<ol style="list-style-type: none"> 1. check the problem according to the item 2; 2. change sensor or sensor connection cable; 3. change the relay or repair the relay of the connecting harness; 4. change the fuse; 5. change the battery or recharge the battery ,make the connection; 6. re-connect the harness; 7. connecting to the venting cable; 8. change the blower or repair; 9. change the control panel or repair;

Fault symptom	Possible cause	Eliminating method
compressor not working	<ol style="list-style-type: none"> 1. compressor clutch connecting cable not connected well; 2. clutch damaged; 3. malfunction lamp light up; 4. refrigerant light not lighting up; 5. relay out of work; 6. no harness connection to the battery; 	<ol style="list-style-type: none"> 1. reconnect the cable; 2. change the clutch or repair; 3. refer to the above-mentioned items;
evaporator blower not working	<ol style="list-style-type: none"> 1. relay not working; 2. battery no charge; 3. battery cable connected; 4. air blower harness not connected well; 5. harness connection not good; 6. venting blower cable not connecting well; 7. air blower or blower speed adjustable resistor failure; 8. control panel out of work; 	<ol style="list-style-type: none"> 1. change relay or repair or connect the relay connecting cable; 2. change the battery or recharge; 3. reconnect the battery cable; 4. change the fuse; 5. reconnect the harness; 6. reconnect the blower motor connecting cable; 7. change the air blower or change the resistor for repair; 8. change the control panel or repair

Driver tools table (one each)

No.	Part name	No.	Part name
1	Tool box	21	Flat-tip screwdriver 6*100MM
2	Combination wrench 8	22	Hammer 1 pound
3	Combination wrench 10	23	Slip joint pliers 8"
4	Combination wrench 12	24	Nipper pliers 6"
5	Combination wrench 13	25	Tire pressure gauge 0-1.4MPa
6	Combination wrench 14	26	Valve core wrench
7	Combination wrench 15	27	Filter wrench
8	Combination wrench 16	28	Pry bar also used as rocker lever 55cm
9	Combination wrench 17	29	Pry bar also used as handle 50cm
10	Combination wrench 18	30	Grease gun 400cm ³
11	Combination wrench 19	31	Socket wrench for wheel nut 32(hexagon)
12	Combination wrench 21	32	Torque bar 315 X 25 X 25
13	Combination wrench 22	33	Wrench for front wheel hub bearing nut 70 mm (hexagon)
14	Combination wrench 24	34	Wrench for rear wheel hub bearing nut 110 mm (hexagon)
15	Combination wrench 27	35	Final drive locknut 55mm
16	Combination wrench 30	36	Spare wheel lifter 22X550
17	S-double box wrench 13x15	37	Wrench for drive axle drain plug 10x10
18	Adjustable wrench 8"	38	Jack 16t J1601
19	Adjustable wrench 12"	39	Special tool box
20	Cross-head screwdriver 6"		

The tools above are the state when choose Dongfeng Dena axle, when other axles are applied, driver tools may vary as below

name	cancel	number	add	Axle manufacturer
Wrench for front wheel hub bearing nut	70mm (hexagon)	1	60 X72 mm foursquare	ZF Front axle
		1	2.25''or 57 mm hexagon	MeiChi Front axle
		1	58 mm	North Benz Front axle
Wrench for rear wheel hub bearing nut	110 mm (hexagon)	1	115 mm hexagon	DONG FENG DENA13T
		1	4.03''or102 mm	MeiChi Rear axle
Final drive locknut	55 mm(hexagon)	1	51 mm hexagon	Fangsheng rear axle or Dongfeng Dena or Hangzhou sanhua 9.5T
Socket wrench for wheel nut	32 mm(hexagon)	1	41 mm hexagon	Dongfeng Dena or Hangzhou sanhua 9.5T
		1	21 mm foursquare	Dongfeng Dena or Hangzhou sanhua 9.5T

Note: The tool box may vary according to different axle condition, for details, please refer to the encasement bill.

Tightening torque of main bolts and nuts

Position	Tightening torque (N·m)
Front tyre nut	412~480
Rear tyre nut	294~421
Bolt, connecting lower knuckle and ball pin	245~304
Steering kingpin lockpin nut	60~70
Fixing nut, upper steering knuckle	274~343
Binding nut, tie rod	90~110
Locked bolt and nut between pitman arm and pitman arm shaft	407~434
Fixing nut, ball pin on both ends of drag rod	240~300
Steering gear fixing bolt	294~333
Steering gear lock nut	137~217
Upper fixing bolt and nut between steering bracket and frame	137~167
Lower fixing bolt and nut between steering bracket and frame	275~330
Final drive bevel gear flange nut	395~539
Fixing nut, Front brake backing plate	160~205
Fixing nut, Rear brake backing plate	196~245
Fixing bolt, between driven gear and differential	588~686
Differential housing nut	216~275
Fixing bolt, Front brake chamber bracket	59~79
Fixing bolt, Front brake chamber	40~59
Fixing bolt, Rear brake chamber	167~196
Fixing bolt, retarder housing	128~157
Fixing bolt, axle shaft	137~176
Drive gear bearing cap bolt	120~137
Rear axle oil level check plug	127~157
Lock bolt, front shoe axle	49~69
U bolt, front axle	196~294
U bolt, rear axle	343~392
Lower slotted nut, damper	134~167
Fixing nut, between damper and damper bracket (M20)	88~118
Leaf spring pin locknut	54~69
Front engine mounting bracket bolt	90~110
Coupling bolt, between flywheel housing and frame bracket	80~100
Fixing bolt, between clutch and flywheel	90~100
Fixing bolt, between flywheel housing and clutch housing	60~75
Fixing bolt, between transmission and clutch housing	142~186
drive shaft coupling bolt	215~240
Fixing nut, transmission output shaft rear connecting panel	333~549

Bolts torque table

Torques for bolts with metric unified threads			
Dimension of bolt	Torques N.m*(ft-lb)		
	8.8	10.9	12.9
M4	3(2)	5(3)	5(4)
M5	6(4)	9(7)	10(7)
M6	10(7)	15(11)	18(13)
M8	25(18)	35(26)	45(33)
M10	50(37)	75(55)	83(61)
M12	88(65)	123(91)	147(108)
M14	137(101)	196(145)	235(173)
M16	211(156)	300(221)	358(264)
M18	290(213)	412(303)	490(361)
M20	412(304)	578(426)	696(513)
M22	560(413)	785(559)	942(695)
M24	711(524)	1000(738)	1200(885)
M27	1050(774)	1480(1092)	1774(1308)
M30	1420(1047)	2010(1482)	2400(1770)
Torques for bolts with metric fine threads			
Dimension of bolt	Torques N.m*(ft-lb)		
	8.8	10.9	12.9
M8×1	26(19)	37(27)	48(35)
M10×1.25	52(38)	76(56)	88(65)
M12×1.25	98(72)	137(101)	126(119)
M12×1.5	93(69)	127(94)	152(112)
M14×1.5	152(112)	216(159)	255(188)
M16×1.5	225(166)	318(235)	383(282)
M18×1.5	324(239)	466(344)	554(409)
M20×1.5	461(340)	628(463)	775(572)
M22×1.5	618(456)	863(636)	1058(780)
M24×2	780(575)	1096(808)	1294(954)
M27×2	1147(846)	1578(1164)	1920(1416)
M30×2	1568(1156)	2254(1662)	2695(1988)

The torque values allow bolt yield strength up to 90%, assuming a friction coefficient of μ

The table of Lubricant, Power steering oil and Grease

1 Main assembly lubricant

Oil site	Lubricant	Type	Level
Engine	Diesel engine oil	15W/40	API CH/H – 4/SG
Transmission	Gear oil	SAE 85W-90	API GL – 4/5
Main reducer	Gear oil	SAE 85W-90	API GL – 5

Explanation : 1) Diesel engine oil--API CH -4/SG ,15W/40 , be used upwards -10°C
 10W API CH – 4/SG be used between -5°C ~ -20°C
 5W/30 API CH – 4/SG be used upwards -25°C
 2) Gear oil – could be used between -20°C ~ 50°C

2 Power steering oil

Fulfill standard: General Allison **C-3**. When ambient temperature is low than 10°C, please apply **ATF DEXRON-II D or ATF DEXRON-III** hydraulic fluid to steering gear; when ambient temperature is higher than 10°C, please apply **C-3/10W** hydraulic fluid. **C-3/10W** grade oil can be used in most area all-year generally. **C-3/30** grade oil can be used in moderate temperature area all-year generally.

3 Others

Oil Site	Oil used	Nominate
Clutch	Synthesize grade oil	Nominate to use HZY4, DOT3, DOT 4, or Laike 901 etc., can't mix to use in different type grade oil
Brake system	Synthesize grade oil	DOT3, DOT4, DOT5.1; Laike 901, Laike 901-4, Laike 901-5
Bearing and ball pin	Li - grease	2#
Coolant	Nominate to use SINOPEC brand, YF-2A (upward -45°C centigrade) coolant, can't mix to use different type coolant	

Air braking schematic diagram

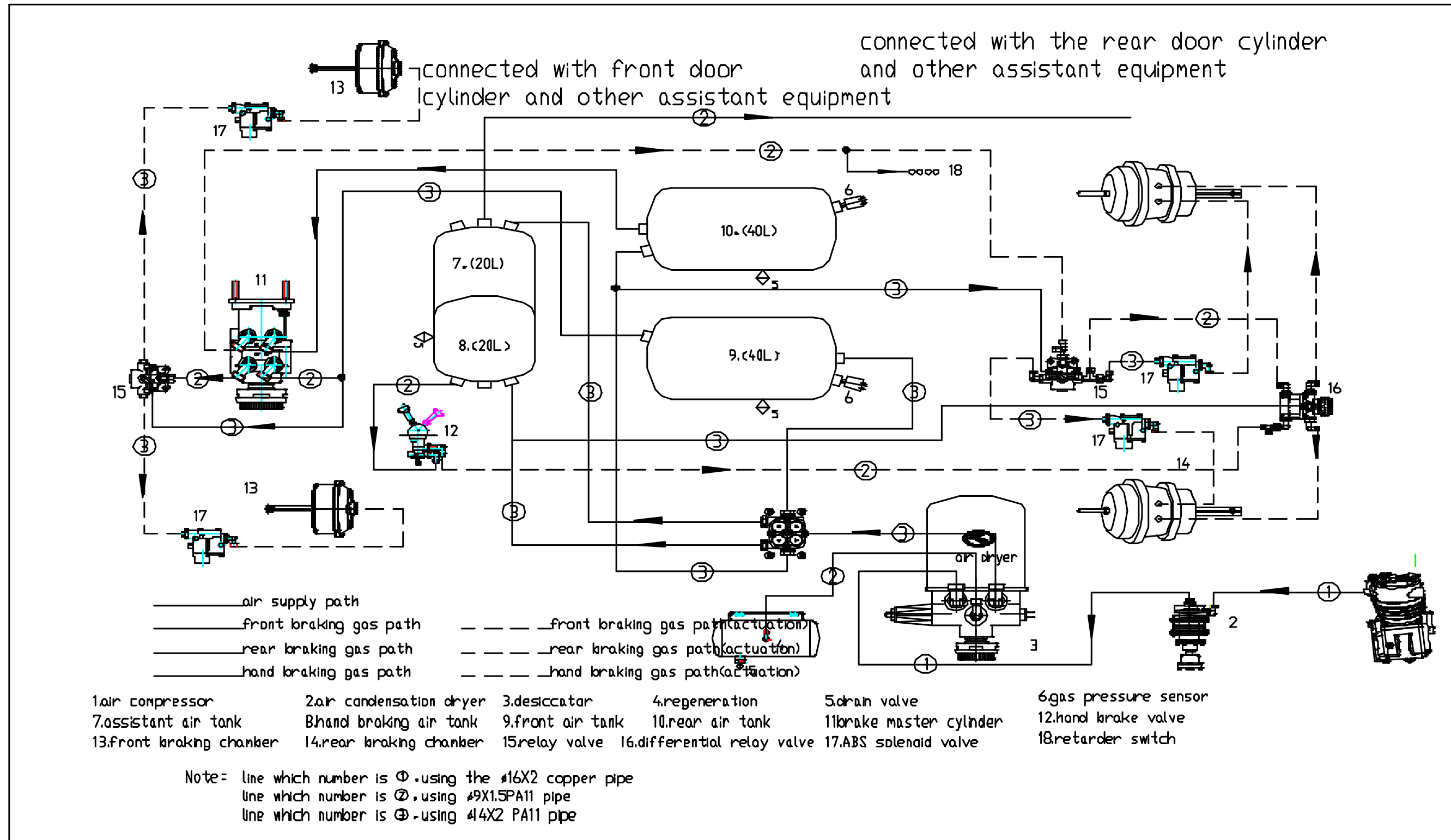

Electric schematic diagram of the complete vehicle (1)

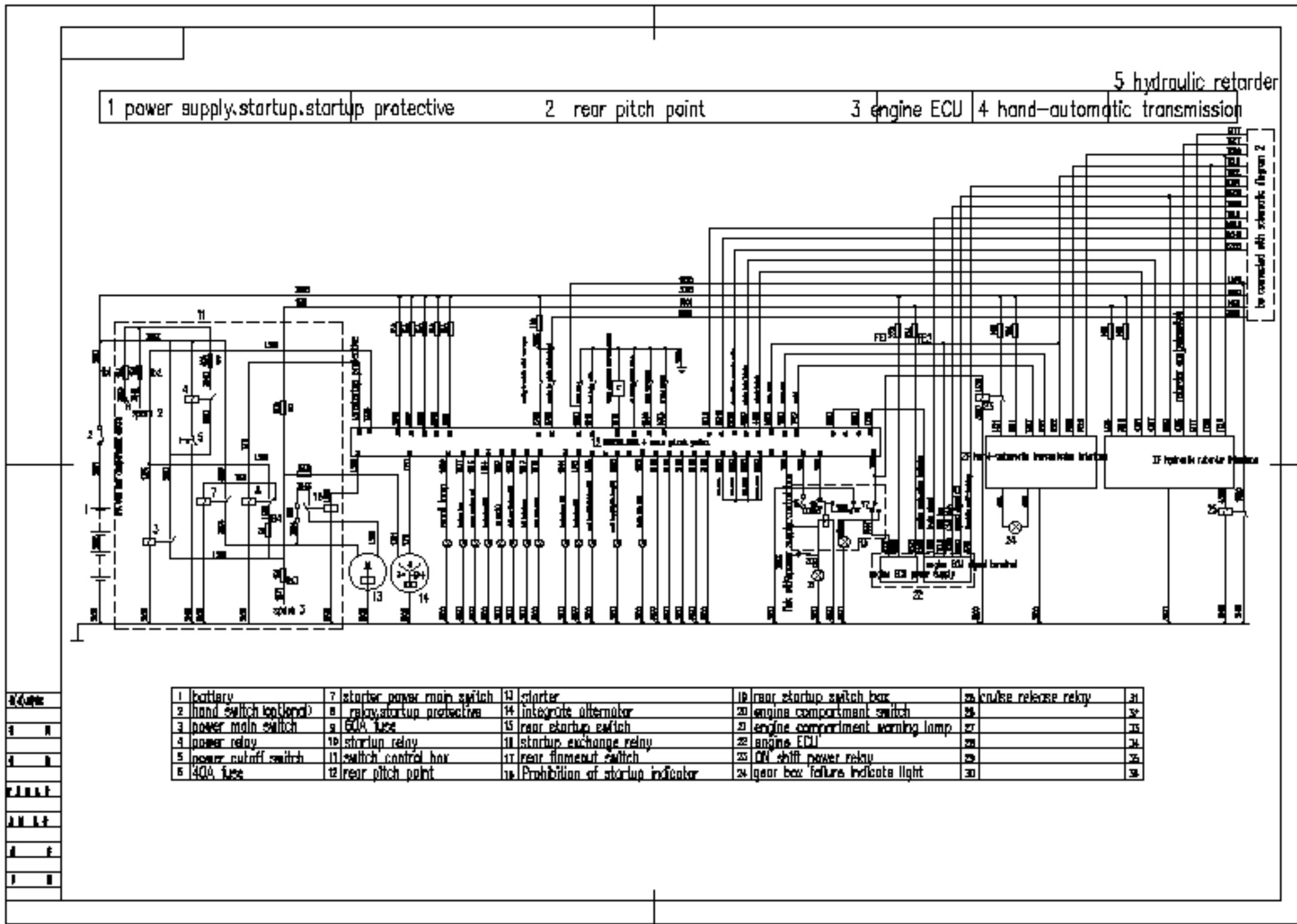

Electric schematic diagram of the complete vehicle (2)

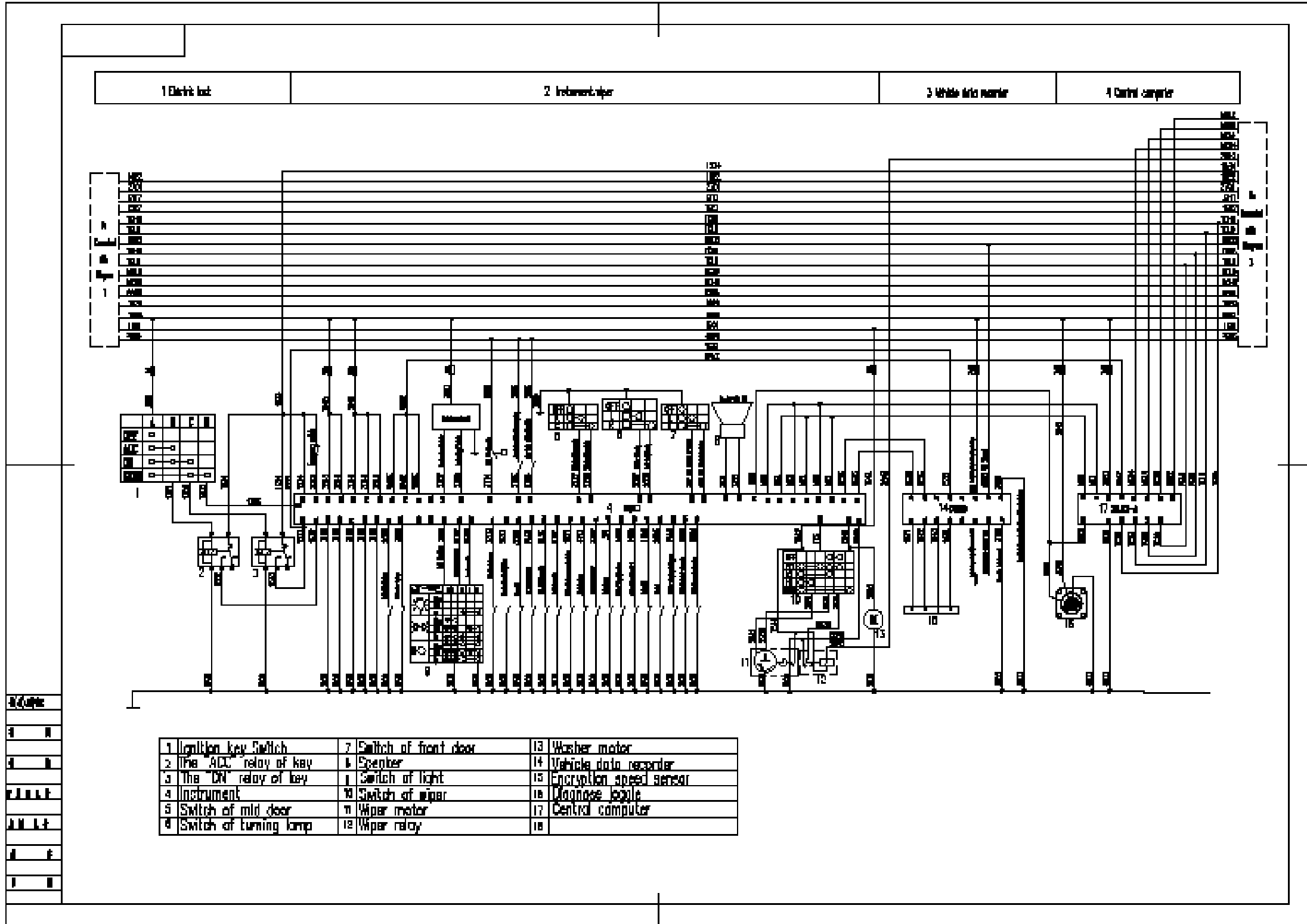

Electric schematic diagram of the complete vehicle (3)

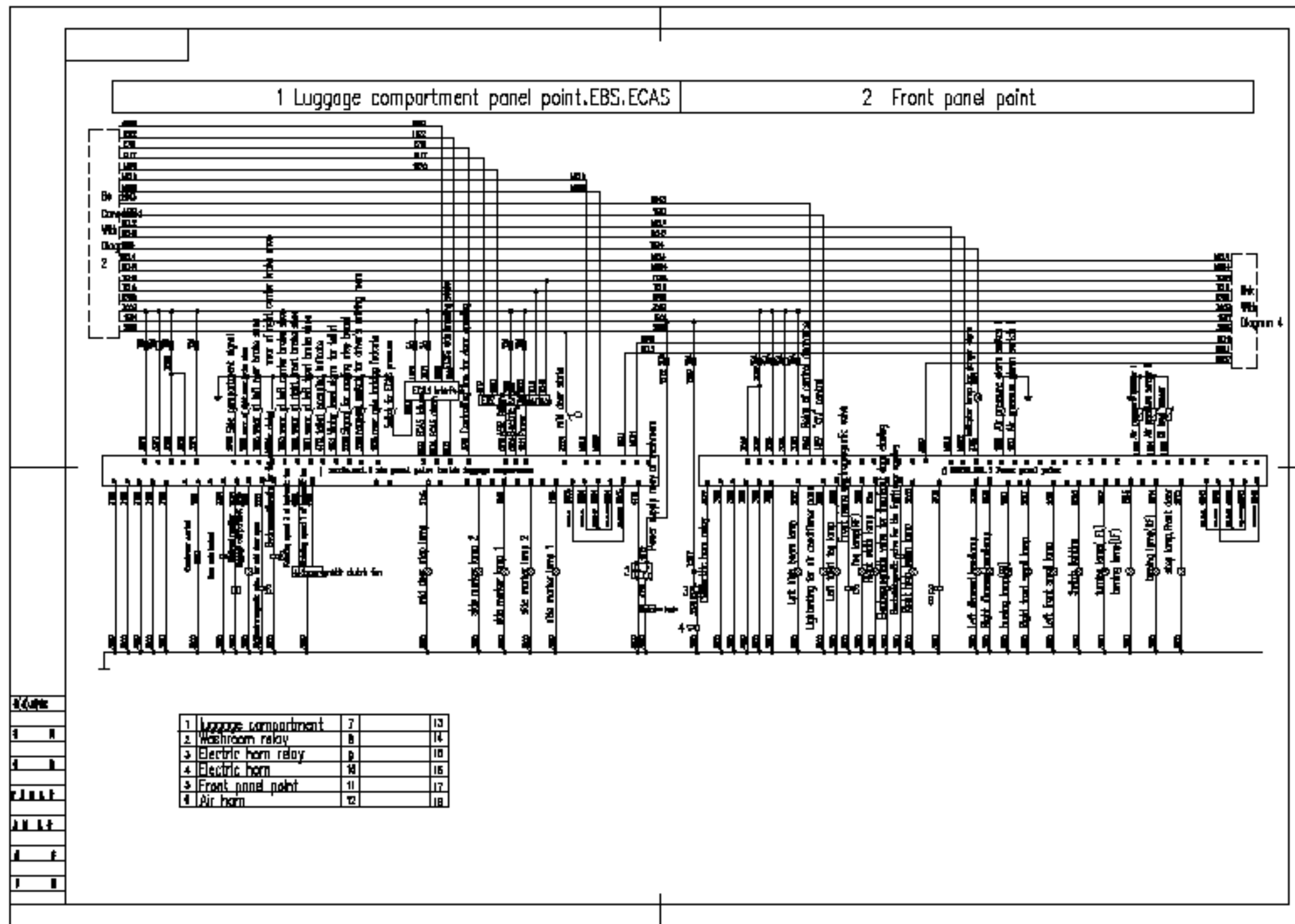

Electric schematic diagram of the complete vehicle (4)

