

I

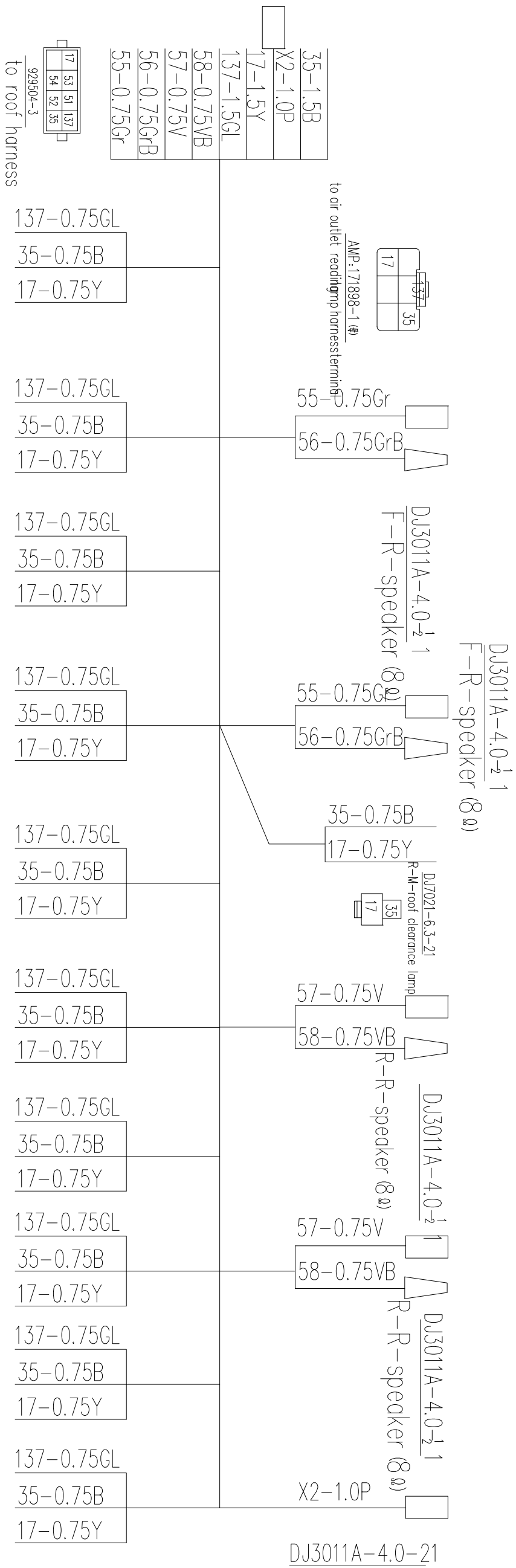

II

37KFM-24500-AMP
reading lamp harness

DJ7025Y-2-2-21 0436605 0436001

0436001 0436605 DJ7025Y-2-2-21

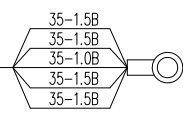
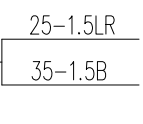
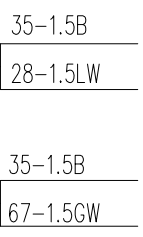
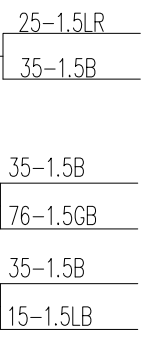
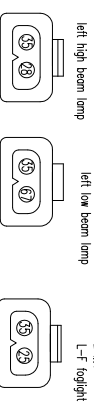
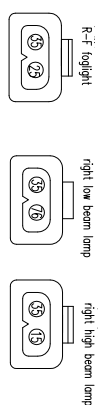

DJ4349-6C
ground

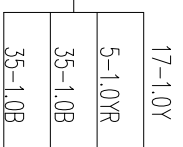
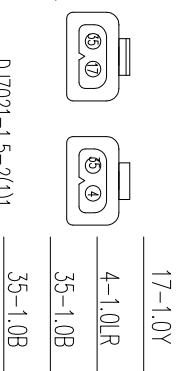

with and right turn lamp

with and left turn lamp

DJ7021-1-5-2(1)1

DJ7021-1-5-2(1)1

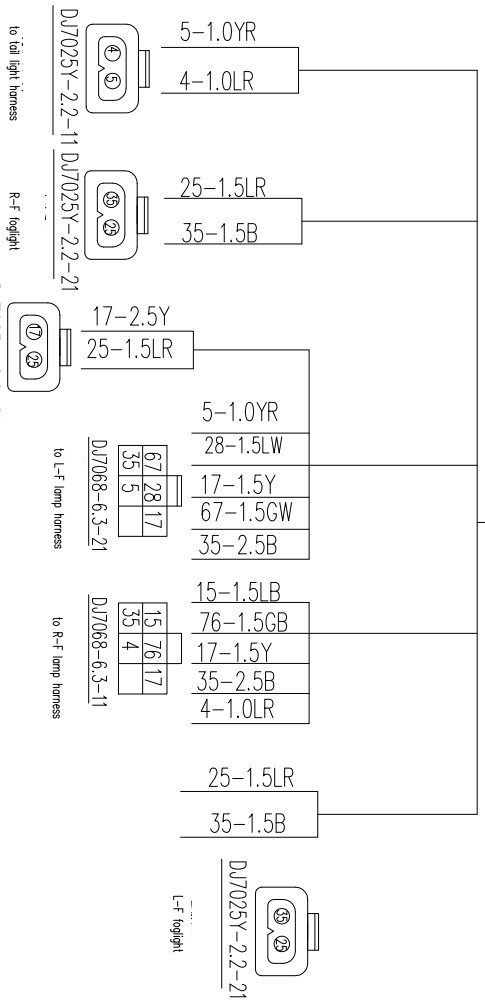

to tail light harness

R-F foglight

DJ7025Y-2-2-21

to dashboard harness

to L-F lamp harness



to R-F lamp harness

front part harness

37KFM-24400

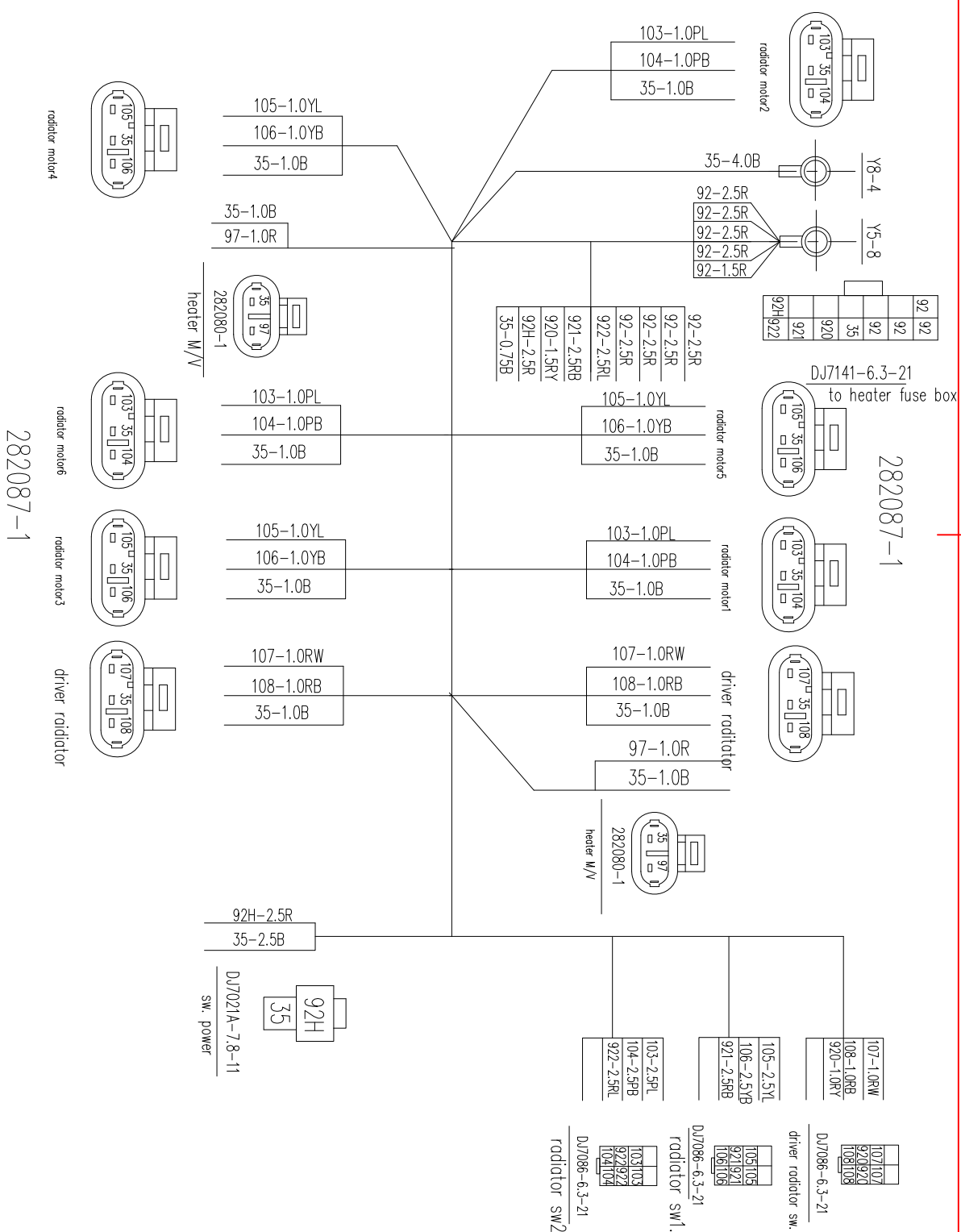

282087-1

282087-1

37KFC-24470

heater harness

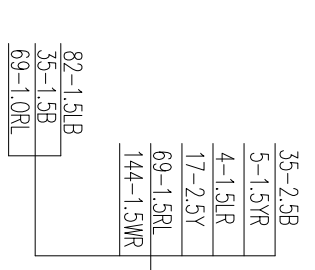

DJ7031-1.5-11
to taillight transition wire

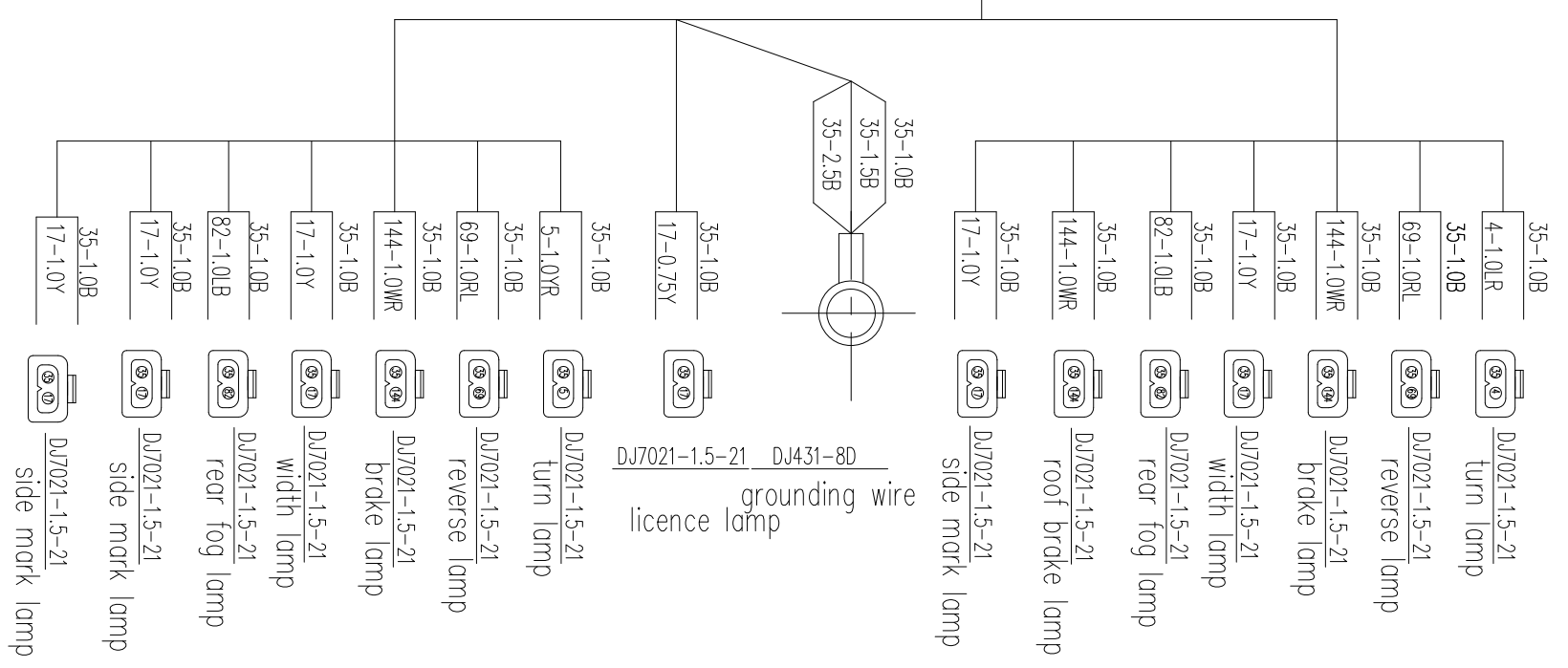

37SF1-24201WH-B
taillight harness transition wire

602-1.0L

603-1.0G

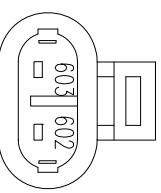

282104-1

to roof-tailight harness

602-1.0L

603-1.0G

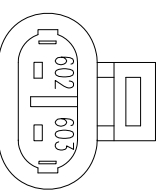

282080-1

fire extinguisher

602-1.0L

603-1.0G

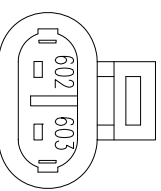

282080-1

fire extinguisher

602-1.0L

603-1.0G

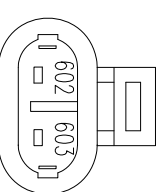

282080-1

fire extinguisher

37HL2-24211

engine COMP.T.fire extinguisher harness

side mark lamp

AMP: 282080-1 35-0.75B

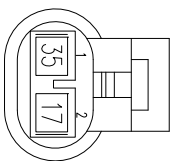

17-0.75Y

35-0.75B
17-0.75Y

side mark lamp

AMP: 282104-1

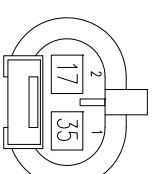

37V56-24209

compartment door lenthen harness

put the grounding wire harness to the frame

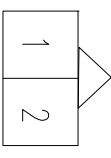
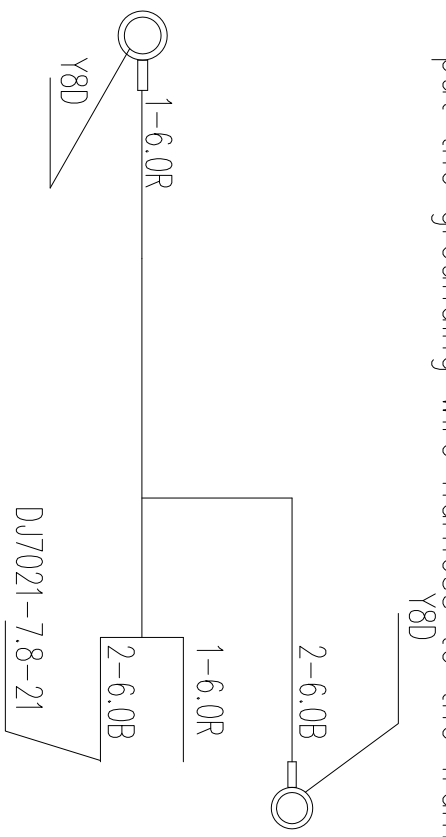

37K55-24930T
Water dispenser harness